

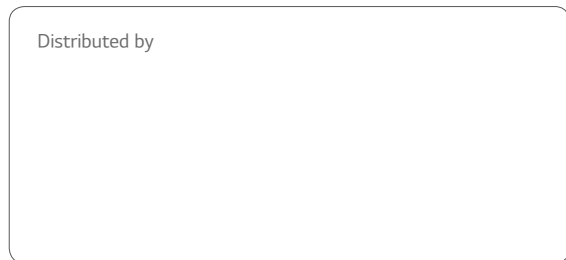

LG Electronics

<http://www.lg.com>
<http://partner.lge.com>

Distributed by



LG HVAC Solution
MULTI V™
For Middle East & Africa



INDEX



OUTDOOR UNITS

016 - 129

MULTI V S	032
MULTI V S	084
MULTI V M	102
MULTI V WATER IV (HEAT PUMP / HEAT RECOVERY)	108

INDOOR UNITS

130 - 217

WALL MOUNTED UNIT	138
SMART DUAL VANE CASSETTE	152
ROUND CASSETTE	160
CEILING MOUNTED CASSETTE	164
CEILING CONCEALED DUCT	180
FRESH AIR INTAKE UNIT	194
FLOOR STANDING UNIT	196
CEILING SUSPENDED UNIT	200
CONSOLE & FLOOR STANDING UNIT	206
COMPATIBILITY / FEATURE FUNCTIONS	214

HOT WATER SOLUTION

218 - 225

HYDRO KIT	220
-----------	-----

VENTILATION SOLUTIONS

226 - 241

ERV	228
ERV WITH DX COIL	240

CONTROL SOLUTIONS

242 - 297

INDIVIDUAL CONTROL	248
CENTRALIZED CONTROL	256
INTEGRATION DEVICE	268

ACCESSORIES

298 - 319

MECHANICAL ACCESSORIES	300
PIPING ACCESSORIES	308

DESIGNED FOR THE ULTIMATE

MULTI V™

From the moment when LG introduced Korea's first residential air conditioner in 1968, the company has continuously enhanced its technological innovation and credibility. As a result of sustained improvement, LG VRF launched the first generation of MULTI V in 2006 and achieved significant development. With world's top class compressor and innovative technology competency applied on every part, cycle and controlling solutions, it has evolved to be one of the world's most efficient and reliable VRF solutions.

Following the first and second generations with Inverter technology and non-ozone depleting refrigerant, MULTI V III has advanced its efficiency with diverse cutting-edge technologies such as HiPOR™ that directly returns oil to compressor and Vapor Injection that allows double compression by adding mid-pressure refrigerant. The innovative technologies of 4th generation MULTI V secured MULTI V brand with product leadership based on efficient system. For example, Smart Load Control that controls operational load according to external temperature. The other technology is optimized to manage refrigerant and heat exchange for cooling or heating.

Moreover, MULTI V's wide range of VRF line-up satisfies various types and sizes of buildings; MULTI V S is the VRF with side discharge, designed for small to mid-sized building and MULTI V WATER is the water-cooled VRF solution with variable water flow controlling technology.

1st
GENERATION
MULTI V™

- Max. capacity 14HP
- 1 Generation Inverter
- AC Inverter

2nd
GENERATION
MULTI V™ II

- Max. capacity 16HP
- 2 Generation Inverter
- DC Inverter

3rd
GENERATION
MULTI V™ III

- Max. capacity 16HP
- 3 Generation Inverter
- BLDC Inverter
- VI

4th
GENERATION
MULTI V™ IV

- Max. capacity 20HP
- 4 Generation Inverter
- BLDC Inverter
- HiPOR™, Oil Sensor, VI
- Range : 15Hz ~ 150Hz

5th
GENERATION
MULTI V™ 5

- Max. capacity 26HP*
- 3 Generation Inverter
- BLDC Inverter
- New bearing with PEEK material
- HiPOR™, Oil Sensor, VI
- Range : 10Hz ~ 165Hz

* Based on Non Tropical model



ENGINEERING TOOLS & SUPPORT

From planning to service & maintenance and then to de-construction, an architectural project goes through many stages from the beginning to the end of its lifecycle. Along those stages, various engineering tools are applied to solve the diverse issues happening in each stage, with the most optimal solution possible. Given the usage of such tools, buildings are effectively designed, built, supervised, and maintained throughout their lifecycle.

Dedicated to provide the best HVAC engineering support, LG Electronics Air-Solution Business Unit offers several engineering tools and solutions focused on HVAC, during the overall lifecycle of a building, related to the three categories : I. Draft Energy Estimation & Energy Modeling, II. Model Selection & Design, and III. Installation Environment Simulation. Among them, the LATS* Program series has been developed to offer the best tool for LG HVAC systems, providing our customers a faster, easier, and a more accurate way in everyday duties of Model-selection, Draft Energy Estimation & Designing, and many more.

* LATS : LG Air-conditioner Technical Solution

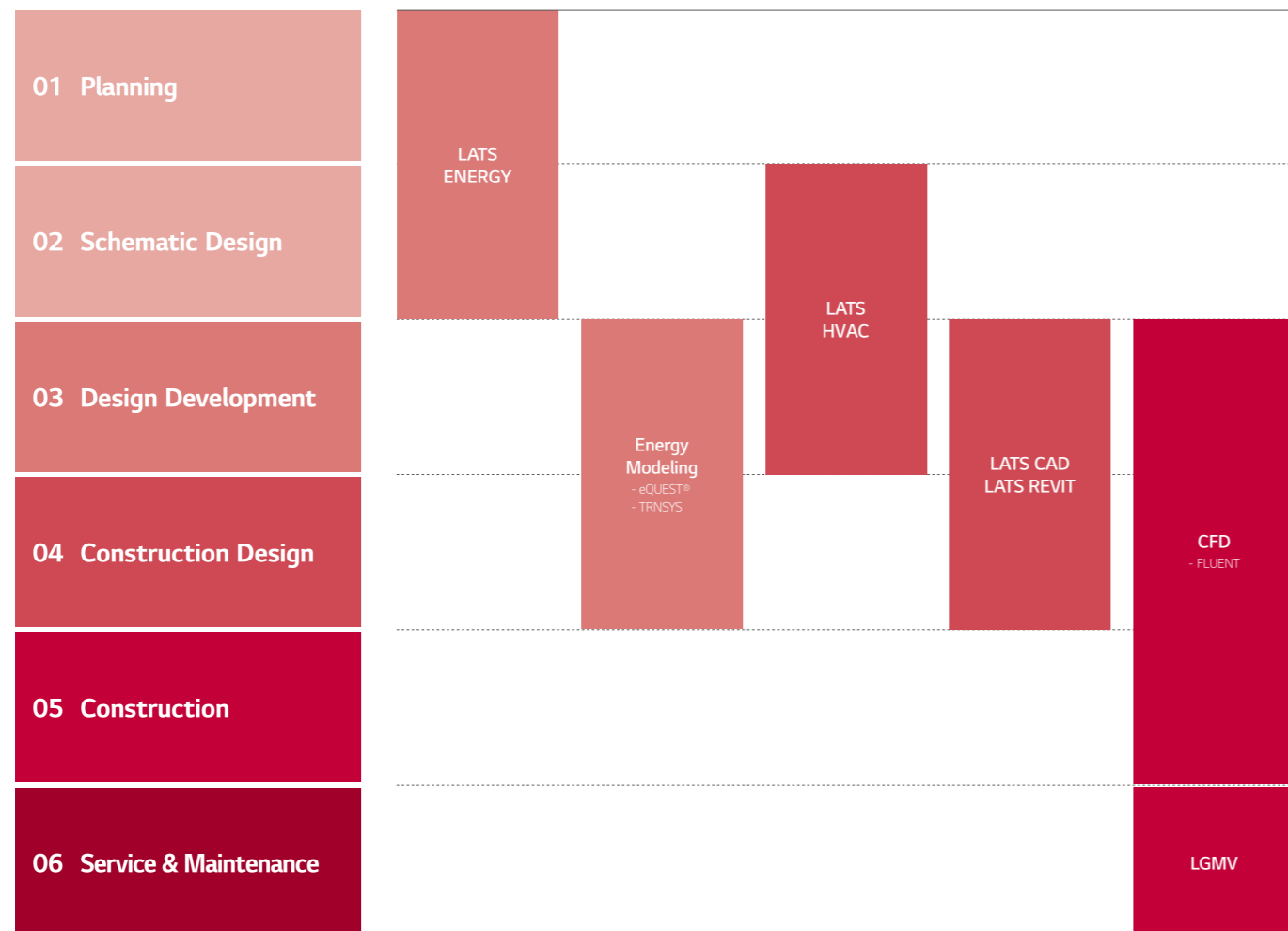
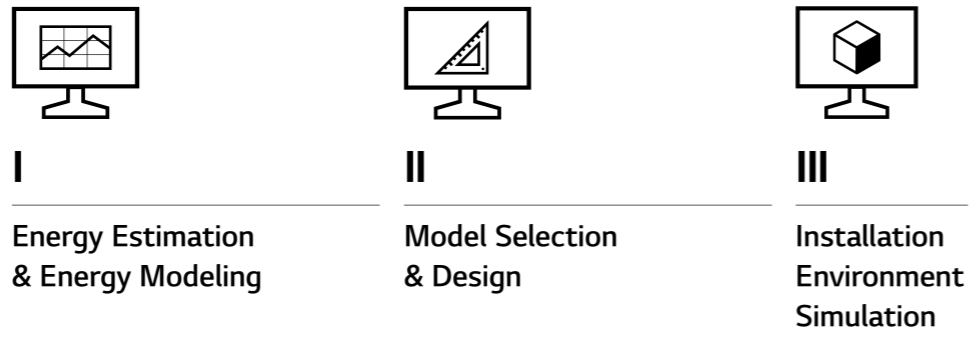

01 Draft Energy Estimation

LATS Energy

LATS Energy program is a draft energy estimation program, self-developed by LG. This program helps estimate the draft energy usage and analyzes the life cycle cost of LG VRF models during the early stage of a project.

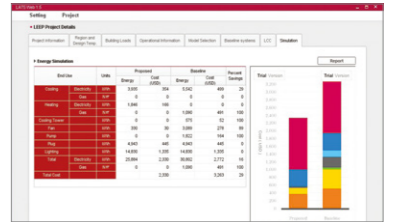

02 Building Energy Modeling

eQuest, EnergyPro, Trace700 and More

These are certified commercial programs which assess the HVAC system efficiency and building's annual energy saving for building standard or certification like LEED. LG HQ supports these programs for the project stages of Design Development and Construction Design wherein the overall designing is finished.

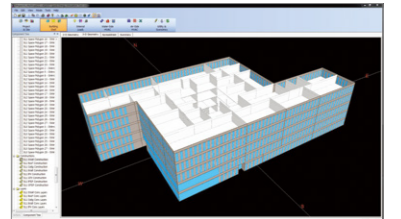

03 Model Selection

LATS HVAC

LATS HVAC is an integrated model selection program of LG HVAC products, enabling an accurate and quick selection on the best model suitable to each sites. In addition to model selection, faster estimation on refrigerant piping diameter and additional refrigerant is possible, along with auto printing of reports.

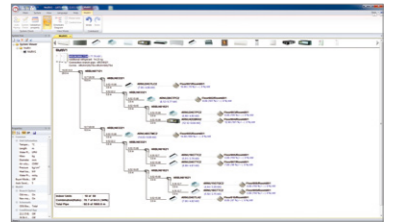

04 Design

LATS CAD

LATS CAD enables faster and more accurate 2D design of LG HVAC products. It also enables modules for quotation and installation review that minimize inherent problems appearing during installation.

※ AutoCAD program is required.



LATS REVIT

LATS REVIT is developed to make 3D design of LG HVAC products.

※ AutoCAD REVIT program is required.

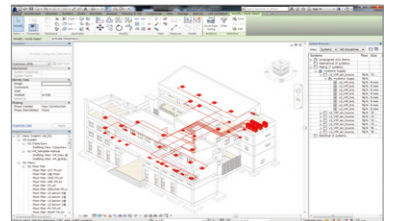

05 Environment Simulation

CFD Analysis

CFD Analysis is applied in areas of estimating : indoor airflow and temperature distribution while operating VRF products, outdoor airflow distribution, and noise level. By running a simulation before construction, engineers estimate possible issues and find optimal solutions of malfunction that could occur after construction.

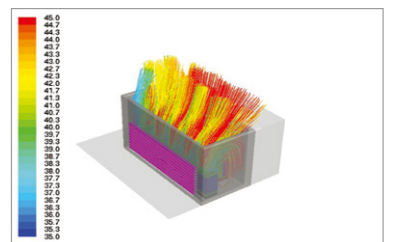

06 Service & Maintenance

LGMV

LGMV offers real-time MULTI V cycle monitoring. During start-up, it's possible to check whether it is normal operation or not. Also it helps to find causes of errors and solve the problem faster.



BENEFITS OF LG MULTI V

Benefits for Building Owners



Efficient Management & Cost Reduction

- Fault Detection Diagnosis enables easy maintenance.
- Requires no extra manpower does not require regular manpower for maintenance.
- With diverse control systems, maintenance cost is minimized.



Reliability Guaranteed in Every Aspect

- Ultimate Inverter Compressor developed and manufactured in Korea.
- Corrosion resistant Ocean Black Fin for harsh condition operations.
- Smart Oil management (Auto Oil Balancing and Active Oil return) decreases compressor damage.



Customized Comfort and Solution

- Compatible option between Heat pump and Heat recovery system is possible.



Benefits for Consultants



Versatile Solutions

- Air-cooled, Water-cooled, Heating, and Air Handling Unit interlocked solutions.



Professional Designing Support

- LATS (LG Air-conditioner Technical Solution) for draft energy estimation, model selection, HVAC design and 3D designing.
- CFD Analysis to ensure suitable solutions and prevent malfunctions.
- Energy simulation offered to find the optimal solution.



Optimized Comfort in HVAC Designing

- Flexible and Longer piping length eases HVAC designing process.
- Meets any type of customer requirements of diverse environment, design condition, and building applications.



Benefits for Developers / Construction Companies



Green Solutions

- Helps scoring LEED / BREEAM points.
- Renewable energy solution provided through geothermal application.



Maximizing Space Utilization

- Large Capacity in compact size enhances space utilization.



Smart Building Solutions

- Easy interlock with Building Management System.
- Wi-Fi control available for anytime anywhere (via mobile app).
- Energy management and control according to usage and planning is possible with LG's centralized control solution.



Benefits for End-users



Operation Cost Saving

- High efficiency is assured through all capacity and lineup.
- Maximum 31% of cost saved through MULTI V 5 Smart Load Control.*



Comfortable Cooling & Heating

- Smart Load Control maximizes indoor comfort level.
- Dual sensing offers pleasant and comfortable cooling and heating environment.
- Duration time of Continuous Heating is 11% longer than previous model.**



Convenient Functions

- Low-noise operation provides a restful environment.

* Dual Smart Load Control ESEER based, below 50% humidity, model ARUM260LTE5
 ** LG internal test result



APPLICATION SOLUTIONS

Office Supporting efficiency with flexibility

High Rise Office Building



- MULTI V WATER IV
- High Static Duct
- PDI
- DX AHU
- Variable Water Flow Control Kit

Small to Medium sized Office Building



- MULTI V 5 / S
- 4 Way CST
- PDI

MULTI V series vitalizes the workspace with fresh air at all time, combined with its various indoor selection. The intelligent control solutions add comfort to the space.

Residential Home is where your comfort is

Condominium & Apartments



- MULTI V S HR
- 1/2 Way CST
- HYDRO KIT
- 3rd Party Controller RTU Gateway

Single Family House & Villa



- MULTI V S
- THERMA V
- ESS & PV Solar

Remarkably compact size and high static pressure of MULTI V S enables optimal space solution, providing comfort to every space through individual zone control and hot water solution.

Commercial Maximize business, minimize costs

Shopping Mall



- MULTI V 5
- DX AHU

Retail



- MULTI V M
- Convertible
- ERV

QSR



- MULTI V M
- HYDRO KIT
- ERV
- 4 Way CST

The highly efficient, energy saving MULTI V 5 and MULTI V M reduces operation costs, and provides comfort that suits any purpose and any space, helping to invest the extra space and expense to your business.

Hospitality Meeting diverse needs in every aspect

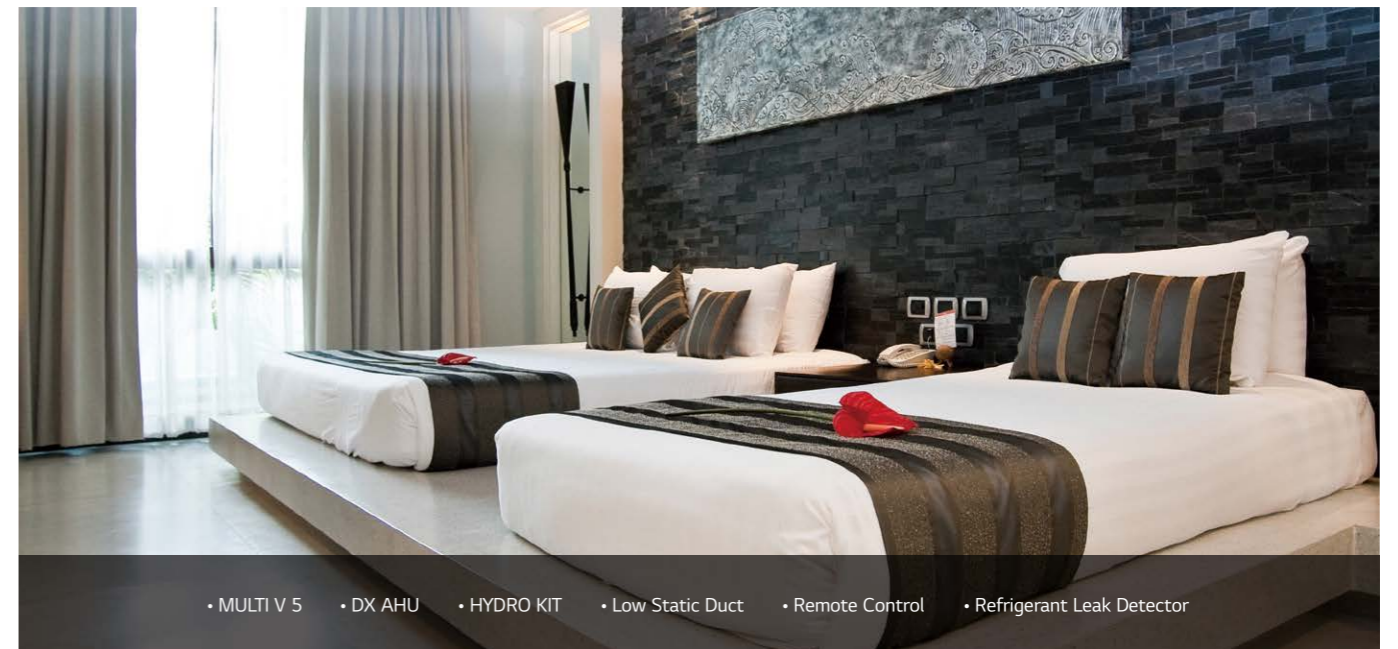

- MULTI V 5
- DX AHU
- HYDRO KIT
- Low Static Duct
- Remote Control
- Refrigerant Leak Detector

The diverse applications that can be applied to MULTI V 5 helps bring just the right solution to a sophisticated hotel business.

DIVERSE INTEGRATED SOLUTION

Hot Water Solution

In order to save costs of providing hot water, using heat pump system is advised as water heating by heat pump is highly efficient compared to a boiler system. The HYDRO KIT can be connected to MULTI V 5, and hot water temperatures up to 80°C can be provided. Also, energy savings can be increased when HYDRO KIT is combined with MULTI V 5 Heat Recovery.

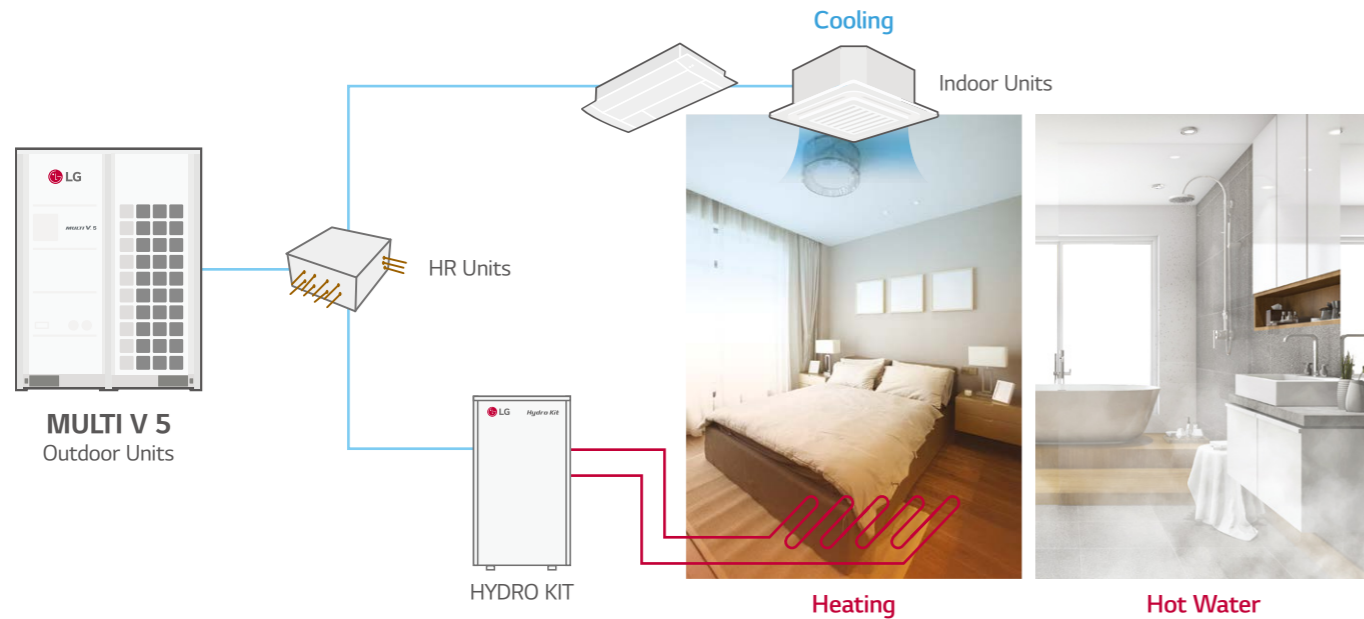

Refrigerant Leak Detection Solution

Real time refrigerant leak detection is needed for a safe environment. When the refrigerant concentration exceeds 6,000ppm for 5 seconds the indoor unit will stop operation and can also give an alarm using a buzzer or a light with the dry contact (option). The central controller can also display an error signal.

※ When the solution for refrigerant leak detection is required, contact LG and discuss the requirement

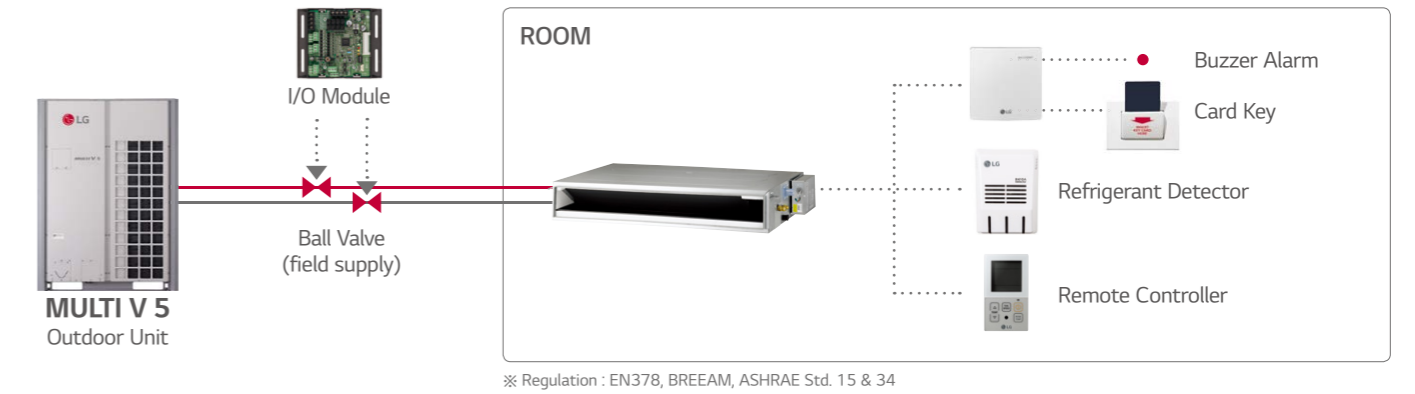

Air Handling Unit(AHU) Solution

An AHU is a solution that can control all air conditioning factors in a large space. With an LG AHU Comm. Kit (for both return air / supply air control) connected to the DX coil of the AHU, LG VRF system can be applied to deliver conditioned air.

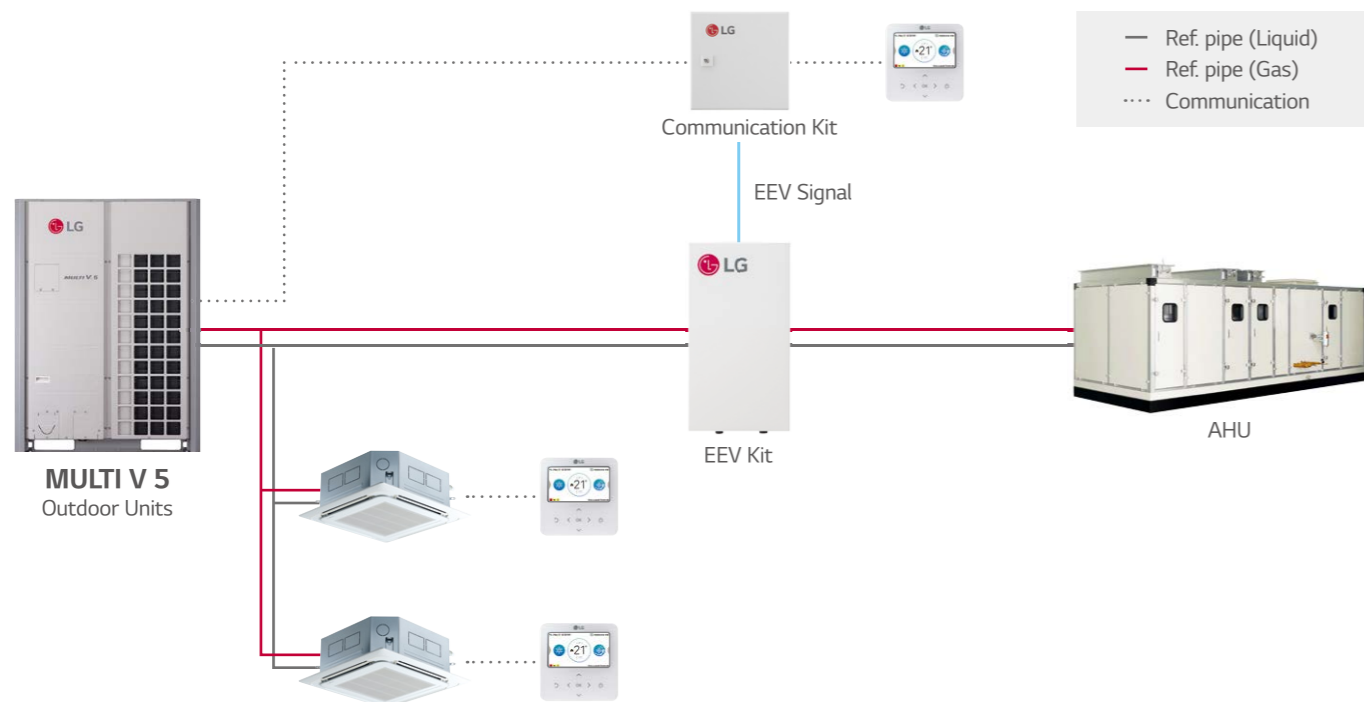

Power Consumption Distribution Solution

In case of shared power consumption in a building, a solution to distribute the power consumption amount per tenant might be necessary. Electricity charges can be billed to each tenant by using output from the LG Power Distributor Indicator (PDI). An administrator is able to check the power usage for each space and date as needed. If the PDI is used in conjunction with an LG central controller, the results can be exported to Excel.

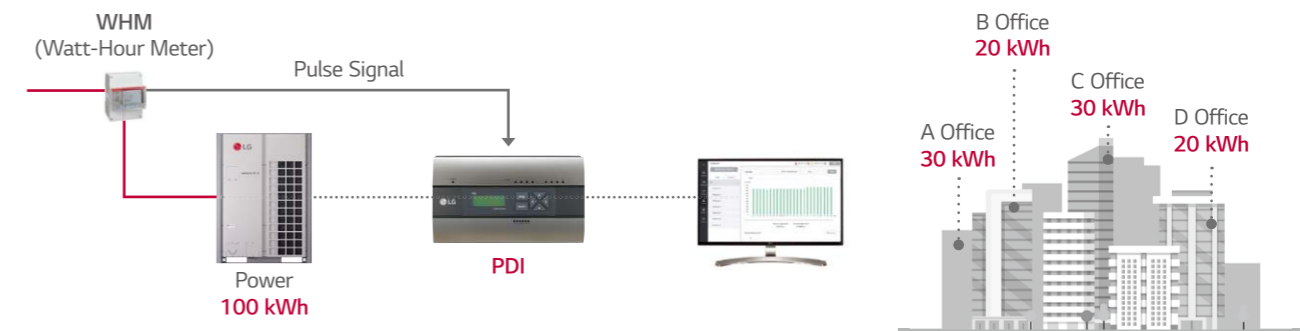

Total Control on Any of Devices

In order to manage multiple spaces and multiple buildings, the administrators should be able to control systems from wherever they are. The LG central controller can be controlled from any web browser that supports HTML5. Now through the implementation of HTML5, the interface will look great and perform well on any of your devices.



DIVERSE INTEGRATED SOLUTION

Energy Management Solution

Since HVAC systems have a significant portion of any building's total amount of energy, the energy saving functions of a controller can make a big difference. The energy navigation function enables you to set target values for energy consumption over a certain period of time. In addition, to achieve that value, the administrator can set the energy saving logic in 7 steps and predict the expected usage relative to the target value. Active self-management enables energy savings through out the building.



Interlocking Solution by Using ACS IO Module

It is costly to introduce a BMS system to control multiple devices or systems in a small building. With the ACS IO module, various IO contact points (DI, DO, UI, AO) can be interlocked and integrated control is possible from the LG central controller. This enables an efficient management of lighting, pumps and other devices in the building in conjunction with the HVAC system.

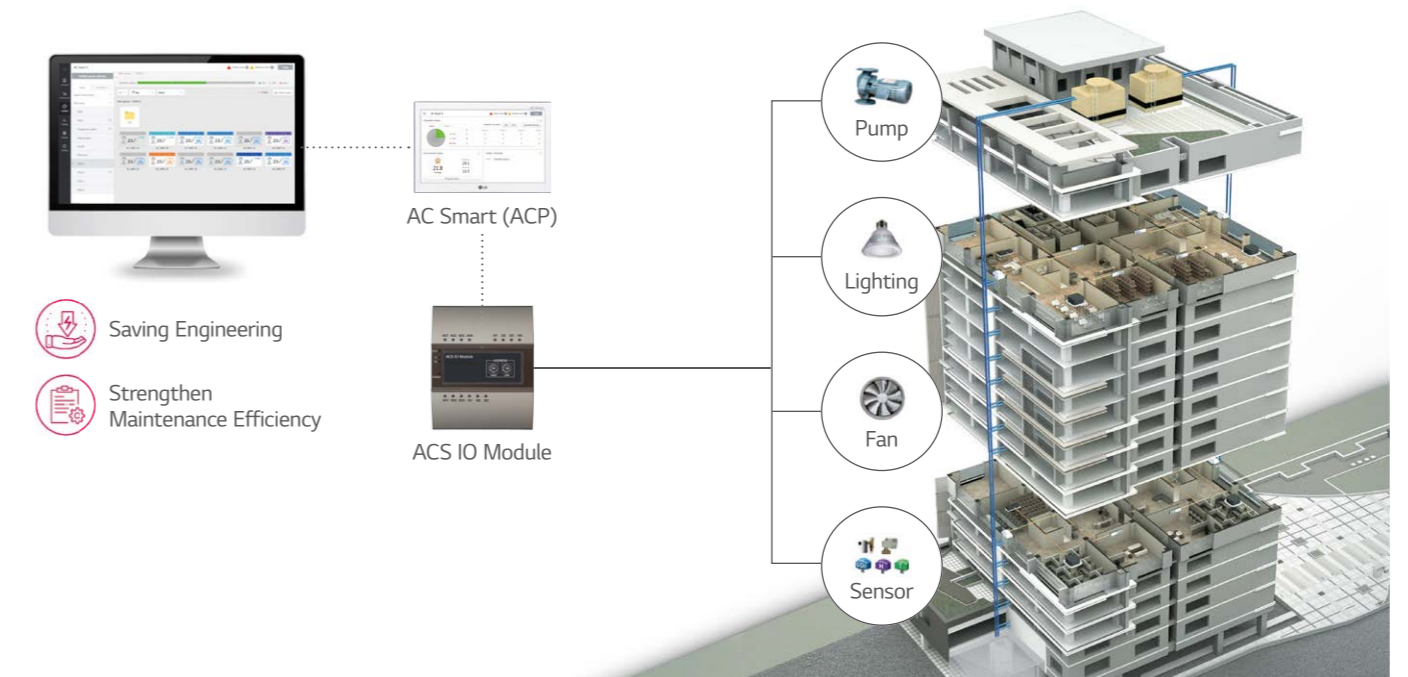

Integration Solution with BMS

There are many BMS protocols used for the control of buildings' various systems such as HVAC, lighting, power and security. LG has a wide range of gateway products for different protocols such as BACnet, Modbus, and LonWorks. In addition, LG gateways include stand-alone central control capability to act as a back-up controller of the BMS if needed.

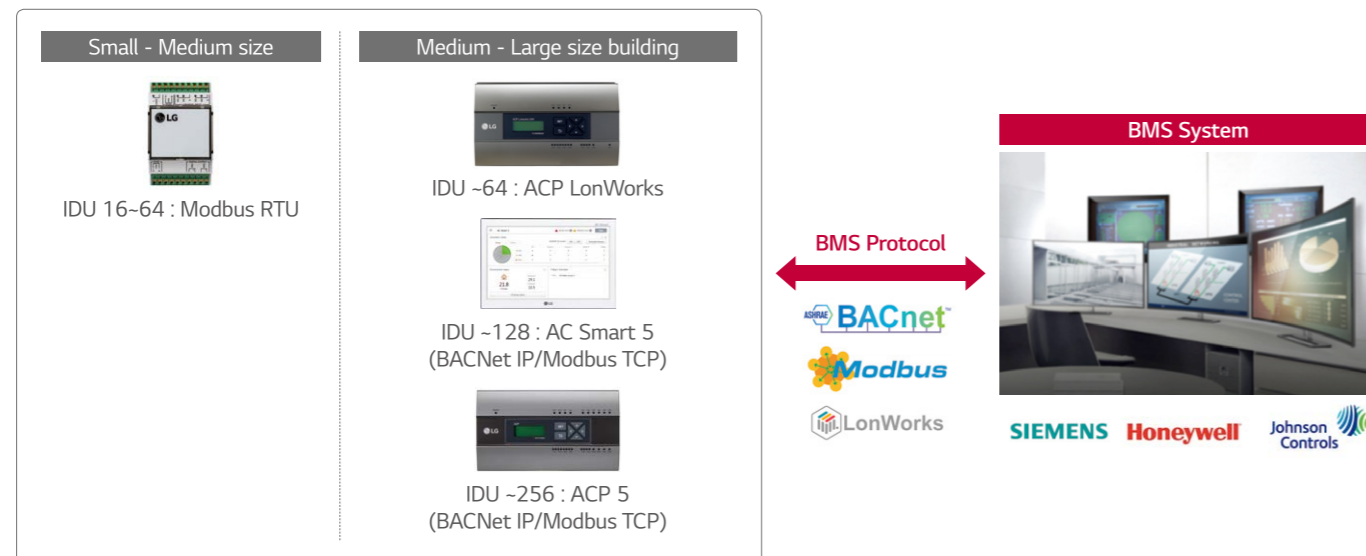

Interlocking Solution by Using Dry Contact

3rd party thermostats can be used to control LG air conditioners in a room by using a multi point dry contact. The dry contact enables basic control of air conditioners as well as making it possible to report the status and any errors impacting the indoor unit. The Standard III remote control has a DO port. With this DO port, it is possible to interlock the indoor unit with 3rd party devices such as lighting, a fan, or a radiator, based on things like operation mode or current temperature. The indoor unit can be interlocked with various types of input such as card key-tag, door sensor, human detection sensor etc. so that the air conditioner is automatically operated depending on situation. In addition, the dry contact option settings enable operation of air conditioner to maintain proper temperature when the occupant is absent. This solution makes sure that the room does not overheat or become too cold when unoccupied so that energy cost can be saved.



OUTDOOR UNITS

- MULTI V 5
- MULTI V S

- MULTI V M
- MULTI V WATER IV (HEAT PUMP / HEAT RECOVERY)



OCEAN BLACK FIN HEAT EXCHANGER

LG's exclusive "Ocean Black Fin" heat exchanger is specially designed for durable and long-lasting performance even in corrosive environments. The black coating is applied for protection from various corrosive external conditions and the hydrophilic film keeps water from accumulating on the heat exchanger's fin, minimizing moisture buildup. This improvement in durability prolongs the product's lifespan and lowers both the operational and maintenance costs.

Ocean Black Fin

Heat Exchanger with Ocean Black Fin for Corrosion Resistance

The black coating is applied for protection from various corrosive external conditions and the hydrophilic film keeps water from accumulating on the heat exchanger's fin, minimizing moisture buildup.



Hydrophilic film (Water flow)
0.2 ~ 0.3 μ m

The hydrophilic coating minimizes moisture buildup on the fin.

Epoxy resin (Corrosion resistant)
1.6 ~ 2.0 μ m

The black coating provides strong protection from corrosion.

Aluminum fin



**Strong Durability
Regardless of External
Environment**



Corrosion Resistance Proven by Certified Tests

LG Corrosion Resistance solution passed ISO accelerated corrosion test conducted by an independent test organization and the result has been certified by prestigious global certification organization, TUV.

Condition of salt spray test

Heat Exchanger	Test Period (hr)		
	1,000	2,000	3,000
Previous Fin			
Black Fin			

※ Based on in-house testing.
 ※ Test conditions : KS (D 9502), ASTM - B117, Temp. : 35+°C / NaCl Concentration : 5% / Avg. spray rate : 1.5 + 0.5 ml / hr

DUAL SENSING CONTROL

The cooling load is based on the amount of both sensible heat load and latent heat load. Most importantly, the cooling load is keen to, and thus, greatly affected by external humidity, rather than the outdoor temperature. For this reason, MULTI V 5's Dual Sensing Control applied function senses both temperature and humidity and applies sensed data for load control in order to obtain in-depth understanding of sensible heat load and latent heat load. This helps preventing excessive cooling load supply and offers the most pleasant and comfortable cooling environment the users want combined with reduction in energy consumption.



Smart Load Control (SLC)

Smart Load Control function enables comprehensive understanding of environmental conditions in order to optimize energy efficiency and maximize indoor comfort level. This technology allows active control of discharge refrigerant temperature which eventually increases the ESEER up to 21% for maximum 26 HP and 15% for average outdoor units in comparison to the previous models.

ESEER Up to 21%
(vs. standard mode at 26HP)

ESEER Up to 15% ~ ESEER Up to 31%
(High humidity) (Low humidity)

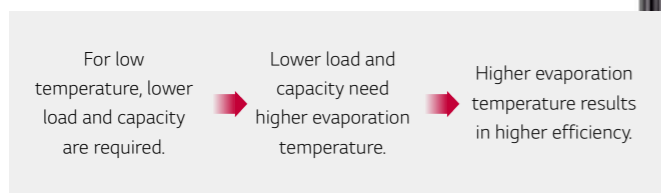

Energy Savings and Optimized Cooling through Temperature and Humidity Control

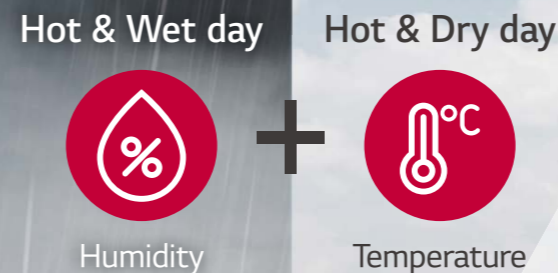

Comfort Cooling

Without stopping in between operations, this function allows MULTI V 5 to maintain operation at mild cooling mode around the set temperature by sensing both temperature and humidity with Dual Sensing Control. By preventing both cold draft and repeated turn On / Off previously required to match the set temperature, users can experience more comfortable indoor environment.

Previous Model | **MULTI V.5**

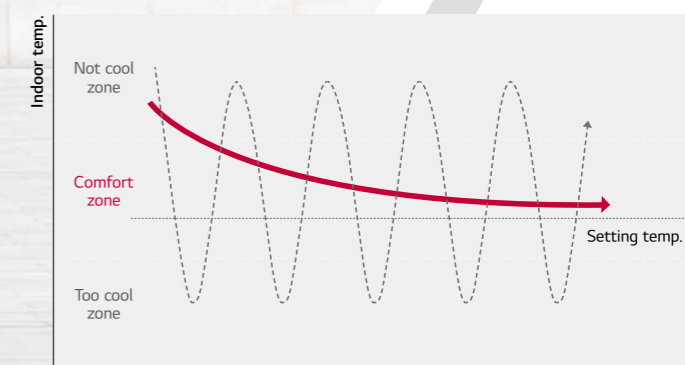

BIOMIMETICS TECHNOLOGY FAN

Enhanced core parts like biomimetics technology-based fans, 4-sided heat exchanger as opposed to 3-sided heat exchanger of previous model and compressor with increased efficiency and capacity allow large capacity for outdoor units. A single unit of MULTI V 5 can provide up to 26HP.



Larger Capacity ODU with Biomimetics Technology Fan



1 Humpback Whale Design
Inspired by the bumps on the humpback whale's flipper, the tubercles on the back side increased wind power by reducing flapping.

2 Clam Shell Pattern
Like the clam shell textures, the range difference created by moire pattern reduced noise level.

3 Increased Air Flow Rate
With extended shroud, discharged air current is stabilized and power consumption is reduced.

“Maximum Capacity and Efficiency”

Enhanced Performance with Newly Developed Fan

Based on the biomimetics technology, the fans of MULTI V 5 increased air flow rate by 10% in comparison to previous model and reduced its power consumption up to 20%. This eventually results in maximized performance with large capacity.

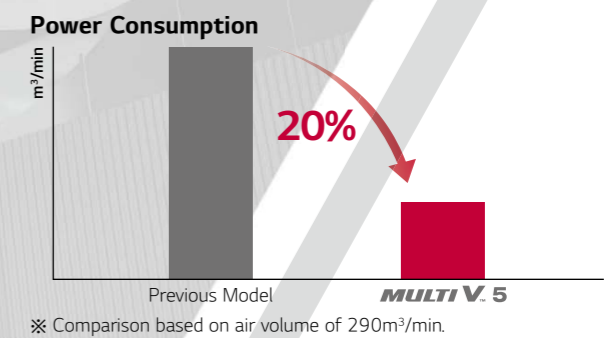
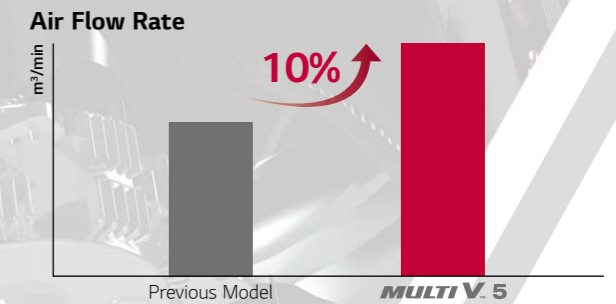

ULTIMATE INVERTER COMPRESSOR

As the core technology of the air conditioning system, the Ultimate Inverter Compressor of MULTI V 5 boasts its ultimate efficiency and durability, designed based on the unique technology and innovation of LG HVAC.



- 01. HiPOR™ (High Pressure Oil Return)**
- 02. Smart Oil Management**
- 03. Wide Operation Range from 10 to 165Hz**
- 04. Enhanced Bearing with PEEK Material**
 - Up to 15% Operating time without oil supply
 - Down to 3dB Noise Level (Max. Sound Pressure)
- 05. Vapor Injection**
 - 10% Improved Energy Efficiency



The Best Durability and Efficiency

HiPOR™ (High Pressure Oil Return)

Resolve compressor efficiency loss caused by oil return.

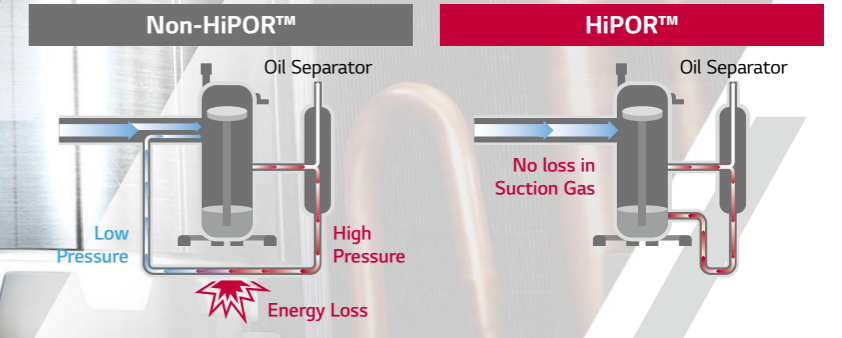

Smart Oil Management

Compressor reliability and efficiency are improved with an oil sensor that allows oil balancing and oil return.

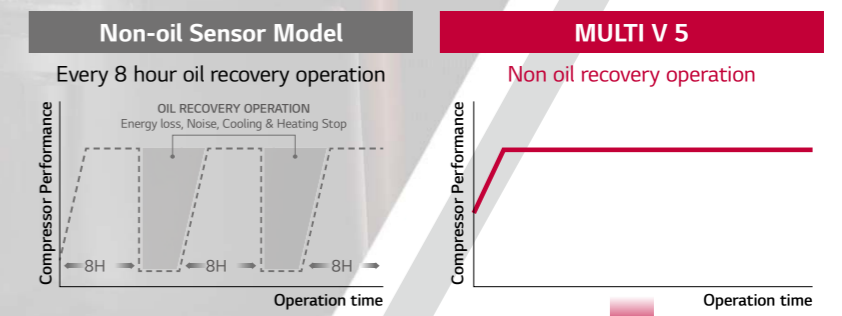

Energy Saving | Noise Reduction | Continuous Cooling & Heating

CONTINUOUS HEATING

Improved technologies such as Dual Sensing Control, Partial Defrost and Smart Oil Management enhance Continuous Heating for increased heating capacity and indoor comfort. The delayed and partial defrost technologies minimize unnecessary operational consumption to provide consistent heating.



Delayed Defrost via Humidity Sensor of Dual Sensing Control

By controlling the evaporation temperature considering the humidity, heating operation time is improved.



※ Outside humidity sensing

Smart Oil Management

Oil sensor of the Ultimate Inverter (UI) Compressor enables smart oil management to provide enhanced heating operation without periodic oil recovery operation.

! Non-oil sensor model | **MULTI V.5**

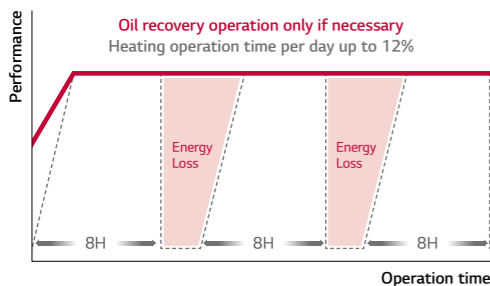

Partial Defrost

Unlike the previous model that stopped heating operation for one-time defrost, MULTI V.5 partially defrosts the heat exchanger by dividing it to lower and upper parts in order to provide consistent heating for the indoor environment and improve heating capacity.

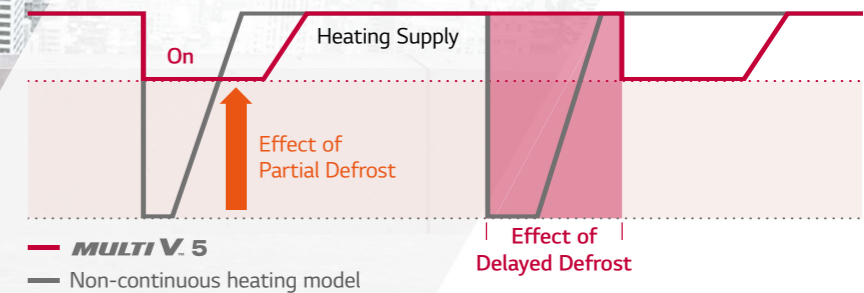

↑ Heating Operation Time Per Day **Up to 11%**

↓ Power Input **Down to 7%**

※ LG internal test result
 ※ Test condition : Outdoor 2/1°C, Indoor 20/15°C, Humidity 83%

AUTO DUST REMOVAL

This feature in MULTI V 5 removes dust on outdoor unit heat exchanger. The outdoor unit fan(s) rotate reversely to blow off the dust. Once the accumulated dust on the heat exchanger is removed, the fan(s) rotates normally and unit goes back to normal operation.

Auto Dust Removal

TROPICAL MODEL



Enhanced Stability from Environmental Constraints

Technology Mechanism

Fan rotates reversely to run sand dust free operation.

Normal Operation

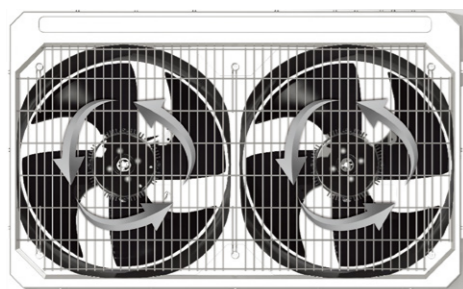

Auto Dust Removal

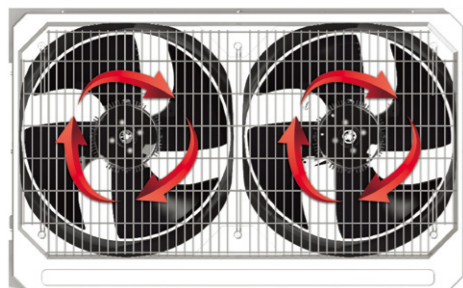

Performance Comparison

Normal Operation



Auto Dust Removal





Optimized for Medium and Large Buildings

MULTI V™ 5

Customer Benefits

- Reduced costs through energy efficiency
- Compatibility with various installation environments
- Strong durability
- Fast and easy installation
- Linkage with various indoor units
- Humidity detection
- Air purification
- Smart management
- Space efficiency



ACTIVE REFRIGERANT CONTROL

Stable Operation & Sustaining Most Efficient Operation

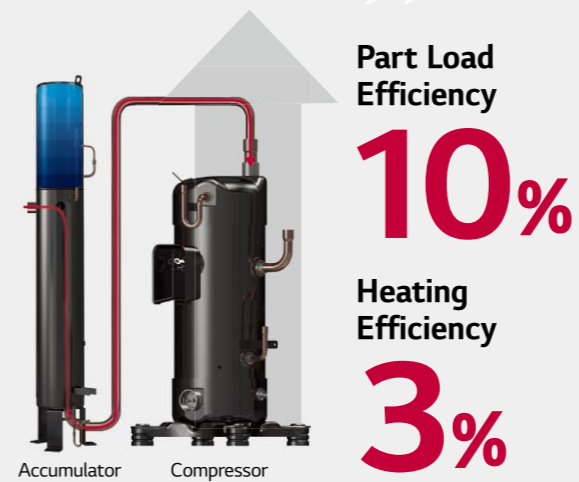

MULTI V 5 active refrigerant control algorithm goal is to minimize the amount of refrigerant in circulation. The lower the volume in circulation the lower the cost to move it around the system and the higher the stability of the refrigeration cycle.

VARIABLE PATH HEAT EXCHANGER

Optimized System Efficiency & Continuous Heating

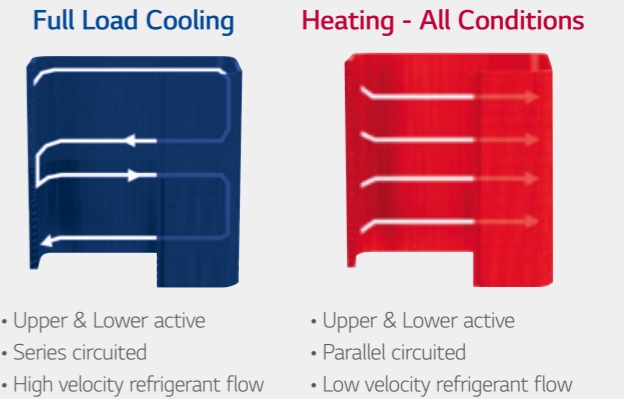

MULTI V 5 outdoor units are manufactured with horizontally split ODU coil consisting of two independently circuited sections. Each half the coil is independently controlled. This split coil feature makes it possible for MULTI V 5 to provide continuous heating during defrost.

COMFORT COOLING

Increased Indoor Comfort & Enhanced Operating Efficiency

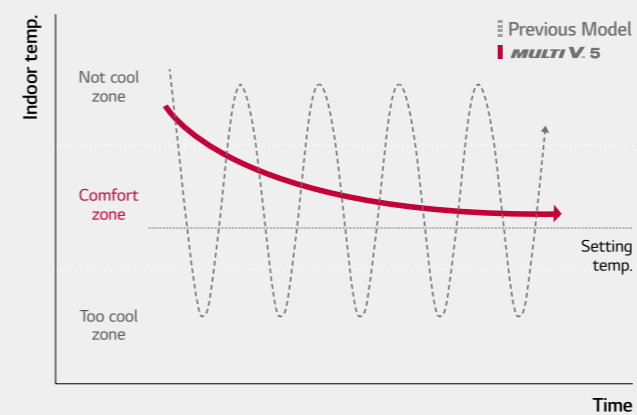

MULTI V 5's comfort control algorithm monitors the outdoor air temperature and humidity conditions. When changing weather conditions are favorable to raising target superheat, target superheat is moderated.

HiPOR™

Maximized Reliability & Efficiency of Compressor

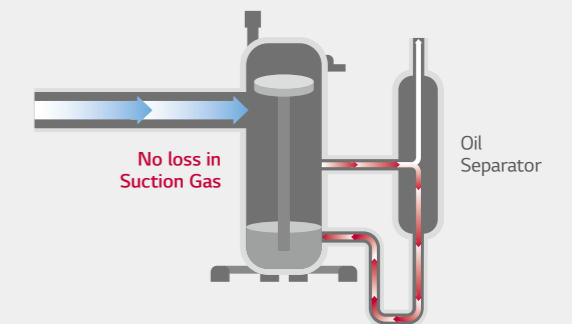

Efficiency Increase Up to **33%**

HiPOR™ technology enables oil to return directly into the compressor, instead of returning through the refrigerant suction pipe. This does not waste energy when oil flows between the separator and the compressor.

MULTI V 5

Piping Length

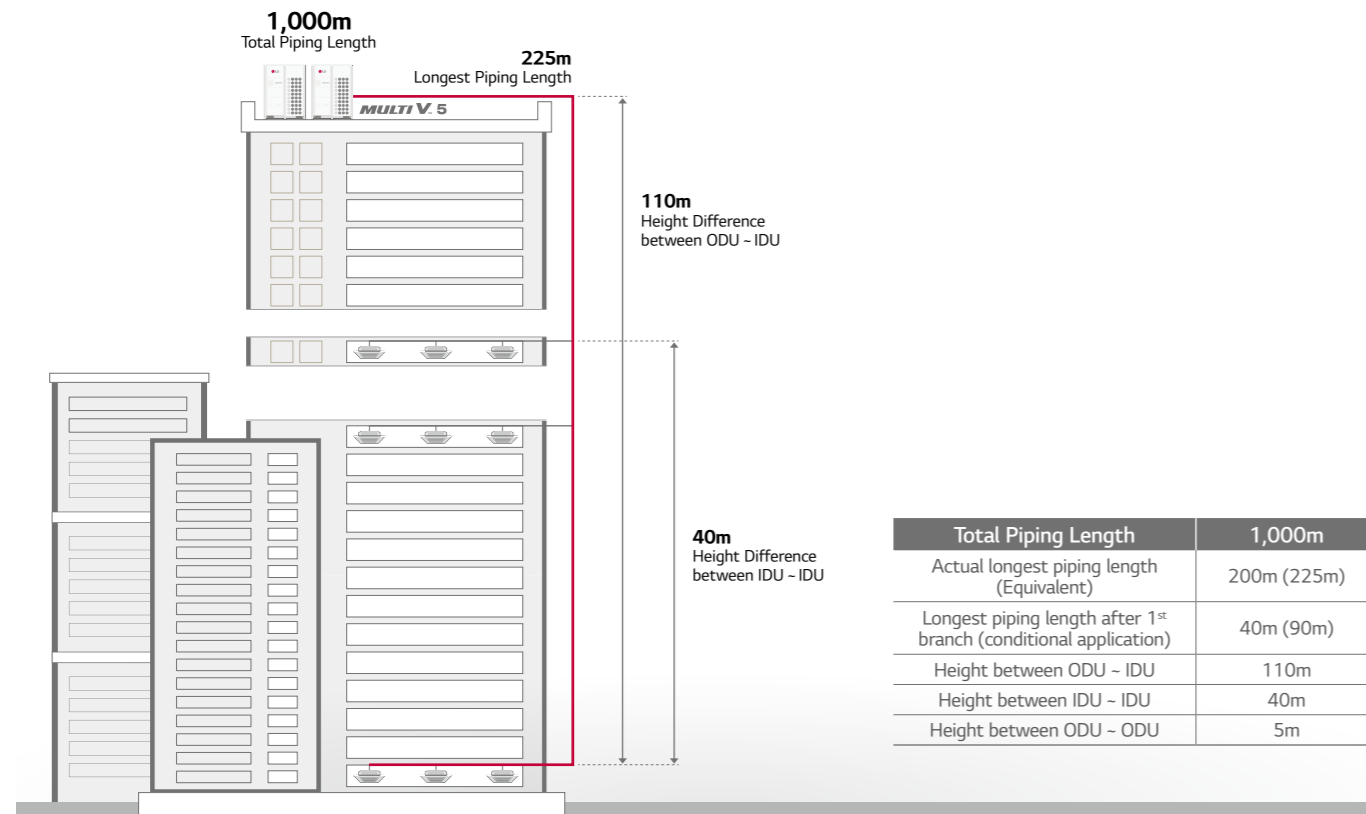

Variable Path Heat Exchanger

Optimized system efficiency & Continuous heating

MULTI V 5 outdoor units are manufactured with horizontally split ODU coil consisting of two independently circuited sections. Each half the coil is independently controlled. This split coil feature makes it possible for MULTI V 5 to provide continuous heating during defrost. The coil circuiting and valve arrangement also makes it possible for the MULTI V 5 controller to change the flow path of refrigerant through one of the two coils only, or through both coils in either a series or parallel arrangement. Based on system pressures, ambient temperature conditions, and mode of operation, the system controller may modify the selected path at any time.

What are the benefits?

Optimizes system efficiency irrelevant of operating modes as ambient weather conditions change. Customizes the area of outdoor units heat transfer surface in use dynamically.

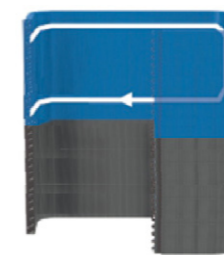

Low ambient cooling and / or light building load

- Half active
- Lower idle



Full load cooling

- Upper & lower active
- Series circuited
- High velocity refrigerant flow



Heating - all conditions

- Upper & lower active
- Parallel circuited
- Low velocity refrigerant flow

Active Refrigerant Control

Stable operation & Sustaining most efficient operation

The accumulator in the outdoor unit has a storage tank mounted inside accumulator known as the receiver tank. The receiver tank is equipped with inlet and outlet valves that are electronically opened and closed. Refrigerant is being passed between the accumulator and the receiver tank on a continuous basis. MULTI V 5 active refrigerant control algorithm goal is to minimize the amount of refrigerant in circulation. The lower the volume in circulation the lower the cost to move it around the system and the higher the stability of the refrigeration cycle. It accomplishes this by constantly monitoring the system operating pressures and temperatures and a variety of other vital control metrics of the refrigeration cycle. When the cycle is out of balance, an adjustment in the amount of circulating refrigerant occurs.

What are the benefits?

Widens the ambient temperature range at which stable operation occurs. Sustains most efficient system operation irrelevant of outdoor weather conditions, operating mode, or building load.

Technology mechanism

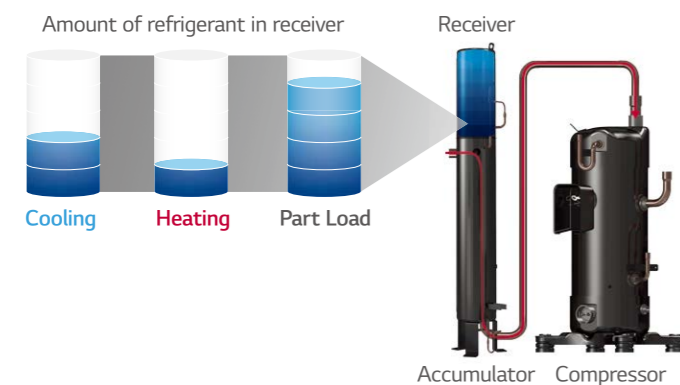

Efficiency performance

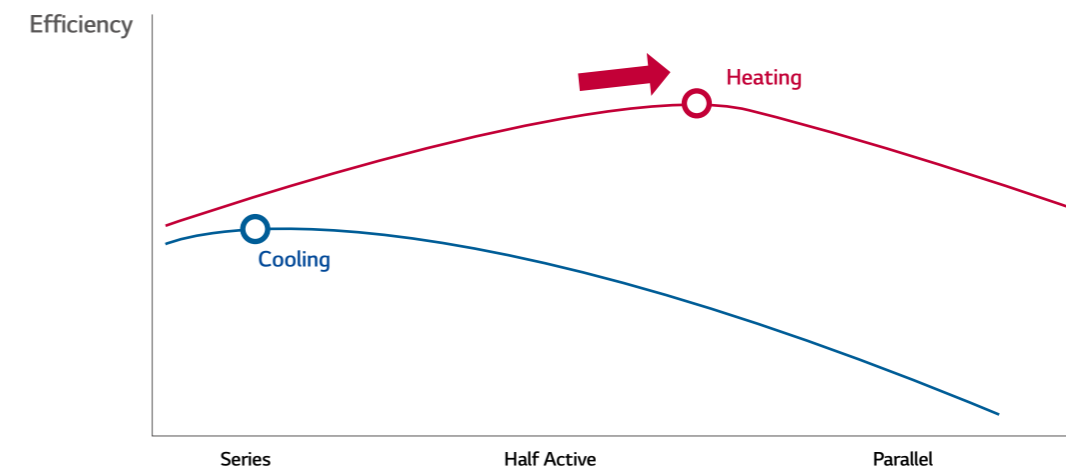
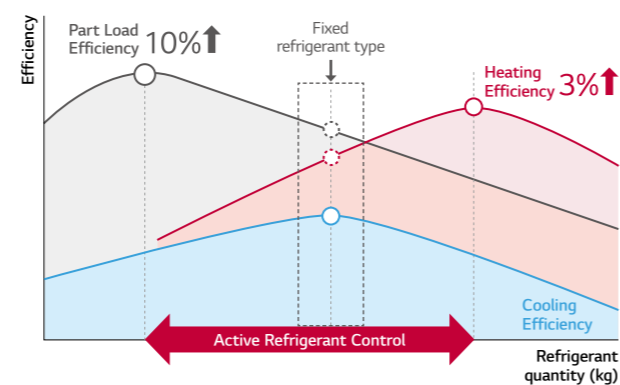

MULTI V 5

Low-Noise Operation

Unlike the previous model which enables low-noise operation only during night after judgment time, the low-noise operation of MULTI V 5 can function regardless of the time at the noise sensitive areas.

Automatic

Noise automatically adjusted

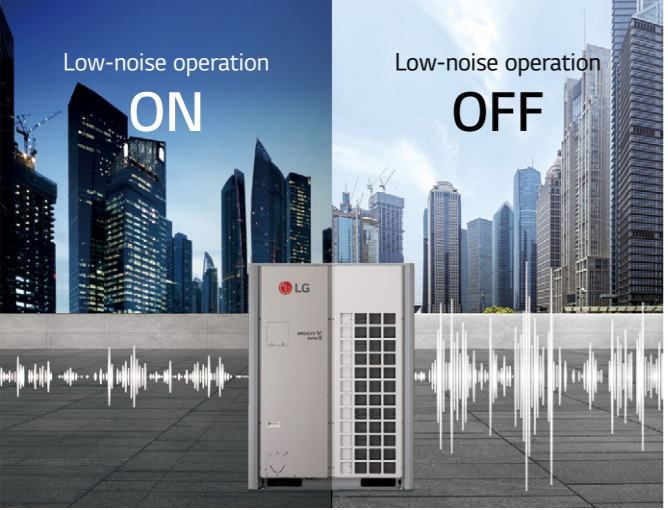

Manual

Choose preferred settings with remote based on noise conditions



※ Indoor unit set up available with Standard III Remote Controller.

Flexible Installation Space with Large Capacity Outdoor Units

Large capacity outdoor units of MULTI V 5 minimizes installation space that spares valuable floor space and significantly decreases total installed weights. This allows users the flexible design potential and better use of the saved space.

Comparison on installation space

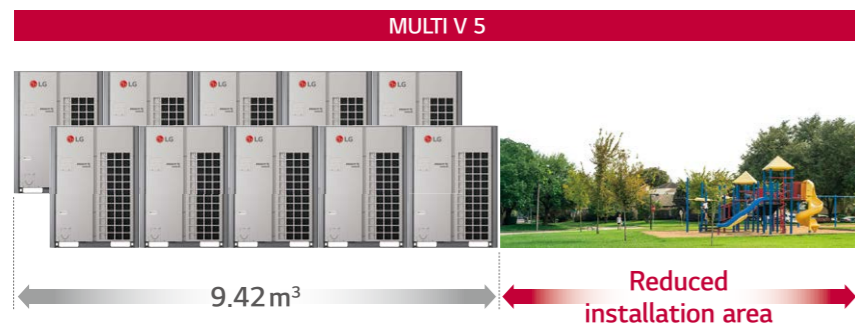

Installation space area comparison

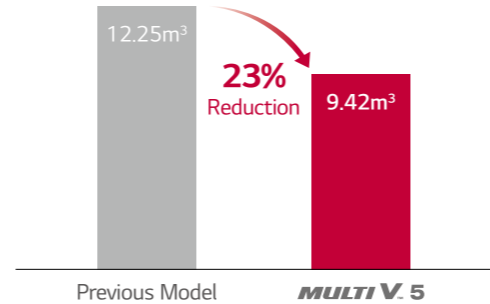

Product weight comparison

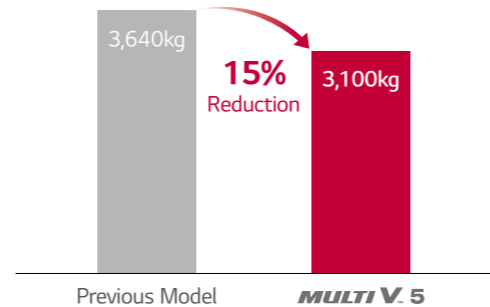

Dual Sensing SLC (Smart Load Control)

Enhanced energy saving & Increased indoor comfort

Cooling loads vary according to both temperature and humidity. With Dual sensing SLC, the proper amount of work can be exerted to meet the load not only depending on current temperature, but also on humidity. As a result, less work will be needed at the same temperature when humidity is lower. It influences the VRF system main processor's decision on where to set the system's target high or low system pressure values.

Smart Load Control monitors two inputs

- 1) Outdoor ambient dry bulb temperature
- 2) Relative humidity

What are the benefits?

Enhanced energy savings

- Cooling Mode : By raising the target low pressure during off-peak cooling operation, the compressor lift is reduced. This slows compressor's speed which leads to a decrease in compressor's power consumption.
- Heating Mode : By lowering the target high pressure during off-peak heating operation, the compressor lift is reduced. This slows compressor's speed which leads to a decrease in compressor's power consumption.

Increased indoor comfort

This function allows MULTI V 5 to maintain operation at mild cooling mode around the set temperature with adjusting compressor's speed by sensing both temperature and humidity.

SLC (Smart Load Control)

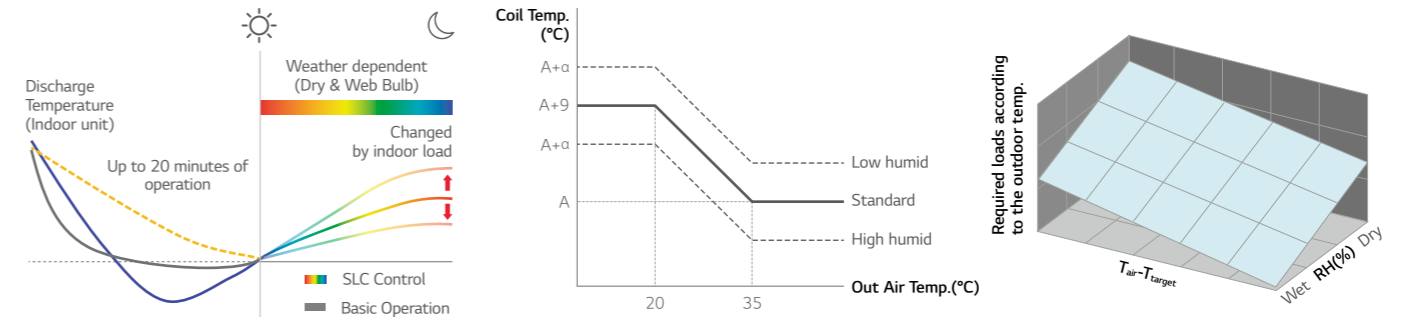

Normal operating mode

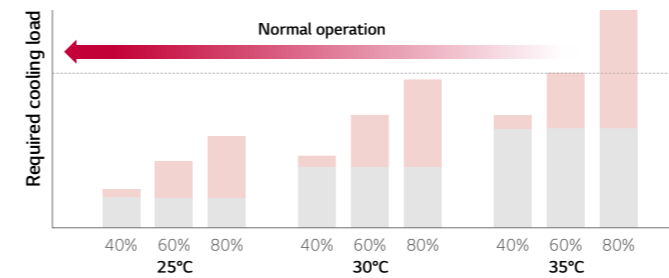

SLC operating mode

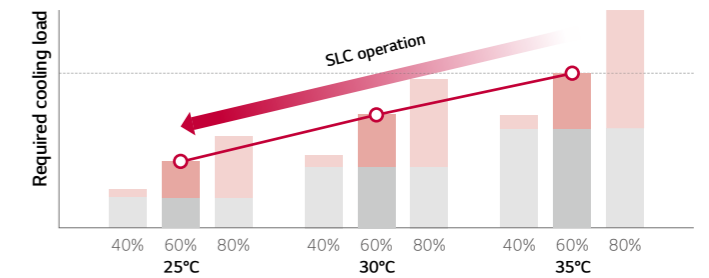

SLC operating mode - Low Humidity

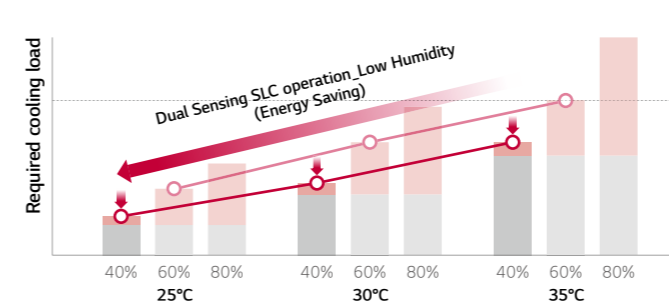

SLC operating mode - High Humidity

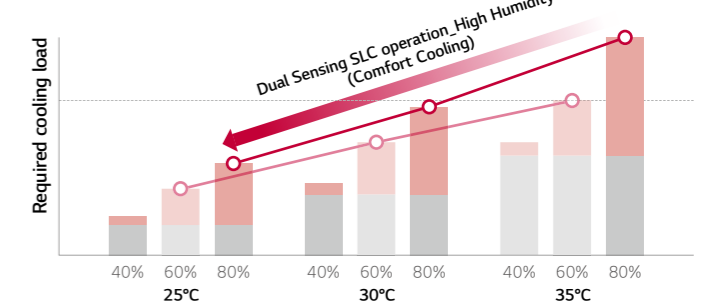

Legend: Latent heat load (red), Sensible heat load (grey)

MULTI V 5

Comfort Cooling

Increased indoor comfort & Enhanced operating efficiency

When the IDU is operating in a season when its load is less than design, the comfort cooling algorithm moderates the indoor unit's coil superheat, thus raising the leaving air temperature as the space temperature is approaching set point. MULTI V 5's comfort control algorithm monitors the outdoor air temperature and humidity conditions. When changing weather conditions are deteriorating and there is a high potential the indoor unit's load will remain stable or may increase, comfort cooling delays or abandons raising the target superheat as the room temperature approaches set-point. When changing weather conditions are favorable to raising target superheat, target superheat is moderated.

What are the benefits?

Increased indoor comfort

If comfort cooling is turned off, and the temperature of the leaving air is not raised, when the fan speed is reduced to low speed, there is a potential that occupants located directly under a cassette IDU or supply air registers could feel cold air falling on them resulting in a lower overall comfort experience. With comfort cooling turned on, the leaving air temperature is moderated. When the IDU controller reduces the fan speed, the potential for cold air falling on occupants located under the cassette IDU or supply air registers is reduced.

Enhanced operating efficiency

Raising superheat reduces refrigerant volume flowing through the coil. As flow decreases, demand on the compressor decreases and the compressor speed will be reduced, thus saving energy.

Previous Model

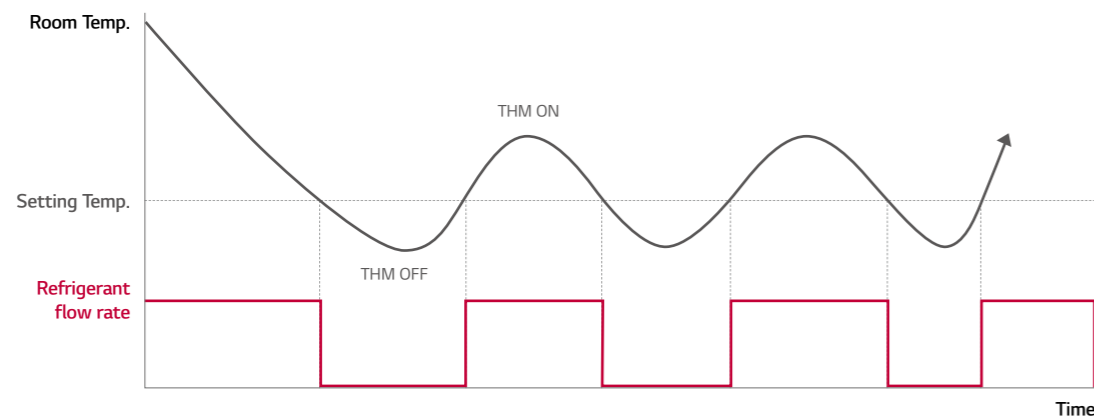

MULTI V 5

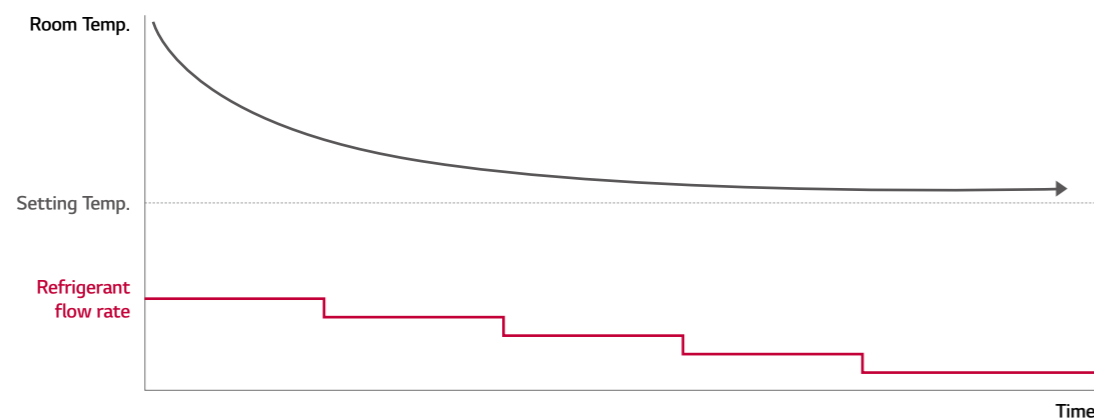

Intelligent Defrost

Increased heating run-hours

MULTI V 5 provides the same user selected defrost mode and method provided by LG's Intelligent Defrost based on current outdoor ambient temperature. With the addition of the outdoor air humidity sensor, MULTI V 5 Intelligent Defrost just got smarter. MULTI V 5 computes the current ambient air dew point temperature - the temperature at which frost will form on the outdoor unit coil in winter operation. MULTI V 5 makes continuous adjustments to the refrigeration cycle operating parameters to keep the outdoor coil surface temperature above actual dew point which can be calculated by using dry bulb Temp. and relative humidity. When the refrigeration cycle operating parameters can be adjusted no further without sacrificing heating comfort, further adjustment is stopped and frost is allowed to build on the coil.

What are the benefits?

The Intelligent Defrost algorithm increases the VRF system's heating run-hours and reduces the number of defrost cycles required to maintain optimum heating performance irrelevant of the mode and method of defrost selected.

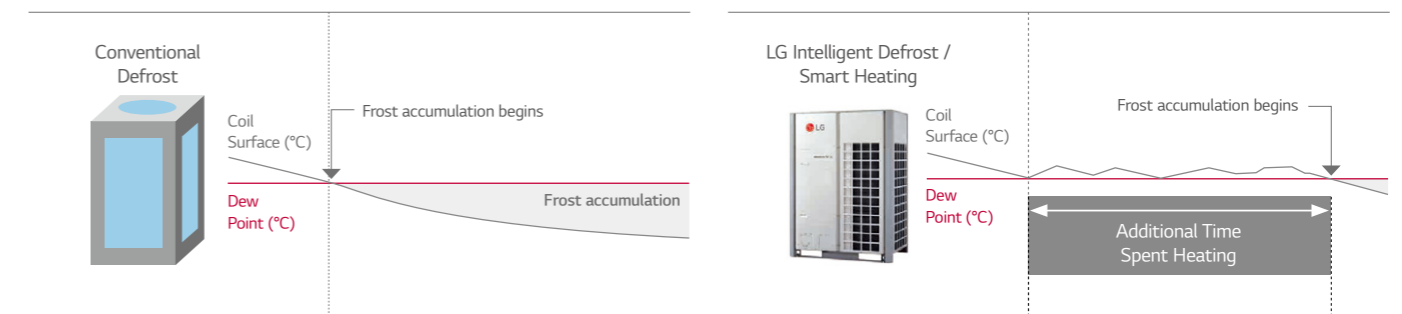

※ Increased heating operation time per day : Up to 17%
 • LG Internal test result
 • Test condition (MULTI V 5 vs MULTI V IV, 22HP)
 - Outdoor : 2/1°C, Indoor : 20/15°C - Humidity : 83%, Dew Point : -0.5°C

HiPOR™

Maximized reliability & Efficiency of compressor

HiPOR™ is a trademark for LG's High Performance Oil Return apparatus. It consists of an oil separator, oil drain line between the separator and the compressor. HiPOR™ technology enables oil to return directly into the compressor, instead of returning through the refrigerant suction pipe. This does not waste energy when oil flows between the separator and the compressor. Because the operating pressure in the chamber containing the oil sump of the compressor and the pressure in the oil separator are nearly equal, there is no loss in compressor efficiency.

What are the benefits?

Maximizes reliability and efficiency of the compressor

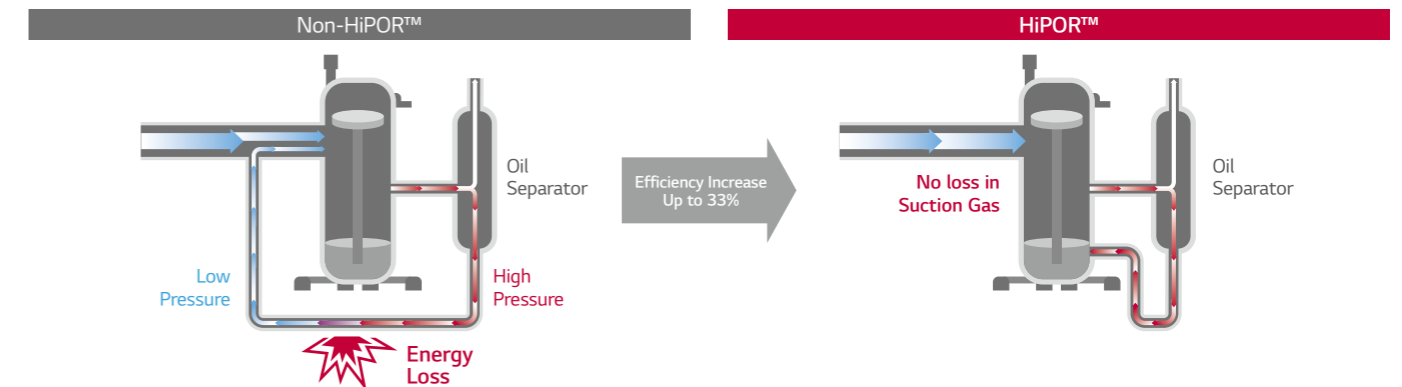

※ LG Internal Test result
 ※ Test condition - 15Hz Rating Condition : TC = 37.9°C, Te = 7.2°C

MULTI V 5

Smart Oil Management

Energy saving, Enhanced heating & Increased compressor reliability

MULTI V 5 performs oil return on an as needed basis under normal operating conditions. An oil level sensor is provided in every LG VRF compressor. If the sensor indicates the compressor oil level is low, the main system processor is notified that an oil return cycle is necessary. Oil balancing cycle occurs every hour and does not hamper system performance. It balances the oil level deposit between both compressors in multi-compressor frames. Older VRF technology protects compressors from oil loss based on timed oil return logic because there was no way to know if the oil level in any one compressor was low. LG's unique oil level measuring sensor actively monitors the oil level in each compressor.

What are the benefits?

Energy savings compared with other systems. Fewer oil return cycles eliminates unnecessary energy consumption. Increases system heating run-time during winter operation. Increases compressor reliability.

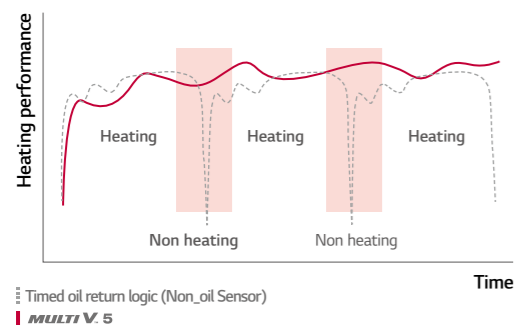

Timed oil return logic (Non_oil Sensor)
MULTI V 5

- ※ Increased heating operation time per day : Up to 12%
- LG Internal Test result
- Test condition
- without oil level sensor : every 8hour oil recovery operation
- with oil level sensor : non oil recovery operation

Smart Oil Return

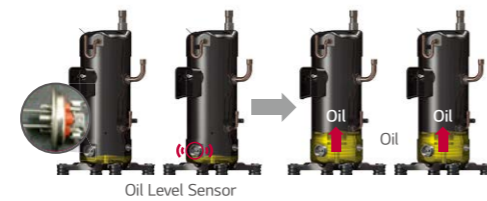

Auto Oil Balancing

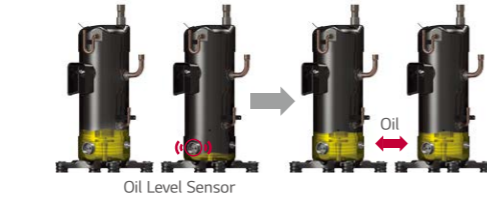

Vapor Injection

Increased heating performance

During low ambient operation down to -25°C, the sub-cooler provides medium temperature refrigerant gas to the compressor's vapor injection system. When injected into the compression chamber, system mass flow increases which stabilizes the system's suction pressure. In all cases the vapor injection increases the compressors cycle efficiency and reduces operating cost.

What are the benefits?

Provides stable refrigeration cycle operation over a wide range of outdoor ambient operating conditions. Increases compressor efficiency when compared to systems without vapor injection technology.

Technology Mechanism

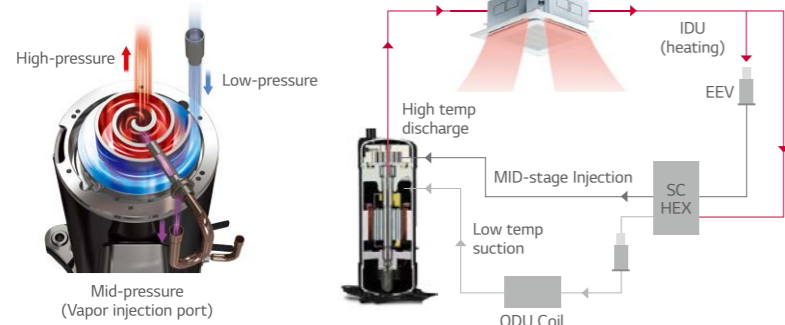

Performance Comparison

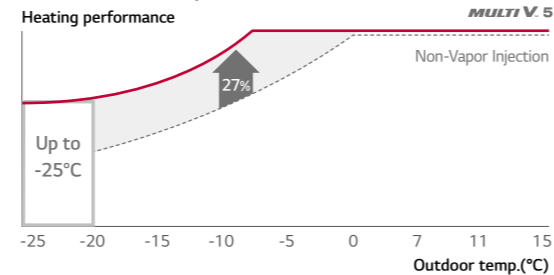

※ Improved heating performance by 27%.
※ Comparison tested on 10HP model.

Ocean Black Fin

Improved durability

The black coating with enhanced epoxy resin is applied for strong protection from various corrosive external conditions such as salt contamination and air pollution including fumes from factories. Moreover, the hydrophilic film keeps water from accumulating on the heat exchanger's fin, minimizing moisture buildup and eventually making it even more corrosion resistant. LG Corrosion Resistance solution passed ISO accelerated corrosion test conducted by an independent test organization and the result has been certified by prestigious global certification organization, UL (Underwriters Laboratories).

What are the benefits?

This improvement in durability prolongs the product's lifespan and lowers both the operational and maintenance costs.

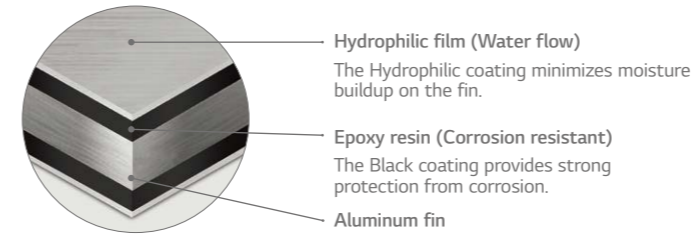

Condition of salt spray test

Temperature	35°C
Mist of 5% NaCl (Mass fraction) solution	

Condition of gas exposure test

Temp.	Relative Humidity	Gas Volume Fraction	
		NO ₂	SO ₂
25°C	95%	10 x 10 ⁻⁶	5 x 10 ⁻⁶

Biomimetic Fan

Maximized performance

MULTI V 5 outdoor units fans have been upgraded. The moire pattern from external texture of clam shells has been applied on fans to create the range difference that results in reduction of noise level. At the same time, unlike the fans installed in previous products that generate separation of flow due to absence of tubercles, the bumpy back design inspired by the bumps on the humpback whale's flipper is applied as the tubercles on the back side of the fans, increasing wind power by reducing flacking. In addition to the biomimetic technology-based fans, extended shroud of MULTI V 5 allows more high static pressure and helps fans to blow higher air volume for efficient operation. With wider air guide, discharged air current is stabilized and noise level is reduced.

What are the benefits?

Based on the biomimetic technology, the fans of MULTI V 5 increased air flow rate by 10% in comparison to previous model and reduced its power consumption up to 20% when compared with the fan blade design on MULTI V IV. This eventually results in maximized performance with large capacity.



Air Flow Rate

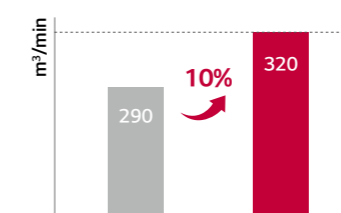

Previous Model MULTI V 5
※ Comparison based on 20HP model.

Power Consumption

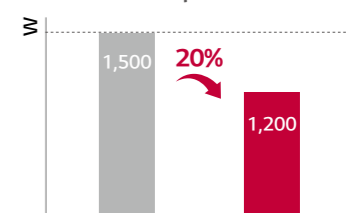

Previous Model MULTI V 5
※ Comparison based on air volume of 290m³/min.

MULTI V 5

One Unified Model

Heat pump / Heat recovery with one platform

LG MULTI V 5 satisfies users' various needs with just one platform. Heat pump system works for the sites where either cooling or heating operation is needed, while heat recovery system fits perfectly to the sites wherein both the cooling and heating operations are simultaneously needed or locations installed with hot water solution to provide hot water and heating via radiator. By providing suitable solutions that cater to any building types and their requirements, MULTI V 5 offers the best HVAC system.

What are the benefits?

MULTI V 5 allows the building previously installed with heat pump system to switch to the heat recovery system for changing purpose of the building or remodeling reasons via simple piping construction.

Heat Pump System

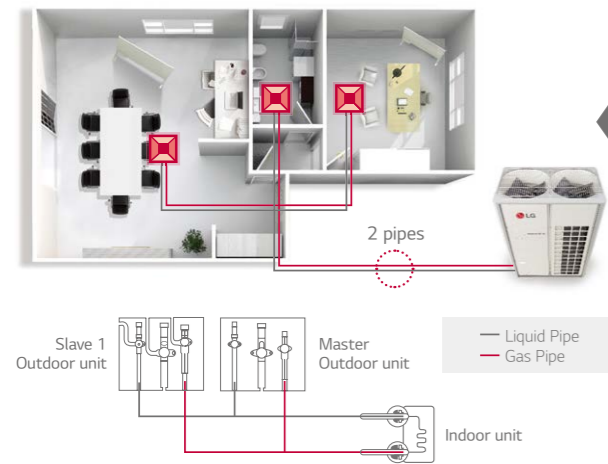

Heat Recovery System

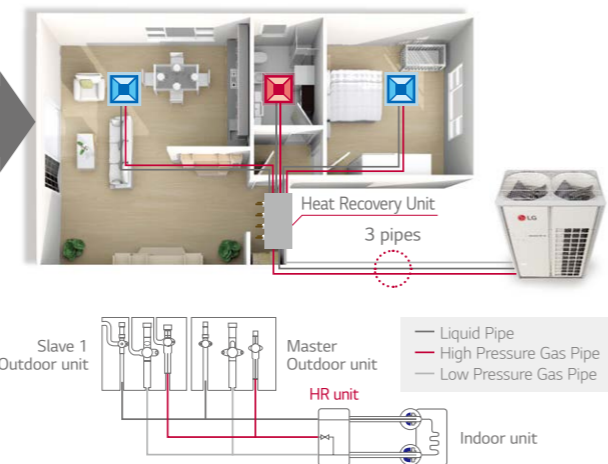

Type Changeover

Wider Operation Range

Able to operate at extreme conditions

With enhanced inverter compressor and control technology coming from improved inverter cooling technology, sub-cooling and vapor injection, MULTI V 5 extended range of cooling and heating operations. For heating, it can operate at as low as -25°C to perform properly even at very cold environment. It is improved perfectly to fully function at extreme conditions such as performing cooling operation at -15°C, making the product adequate for uses in specialized venues like technical rooms. Moreover, MULTI V 5's cycle technology with enhanced durability enables optimal cooling performance at high temperature that increases up to 48°C.

Non TROPICAL MODEL

Heating

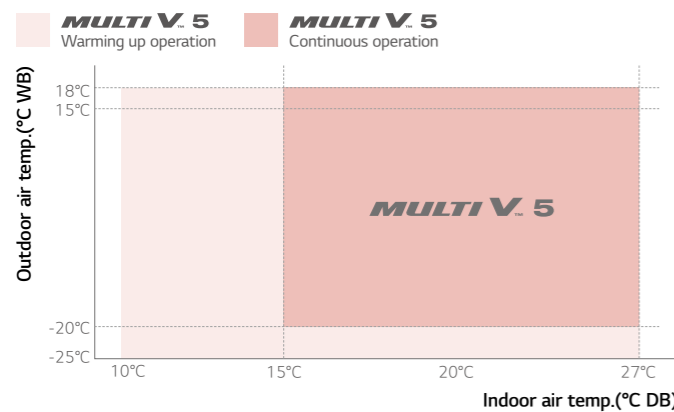

Cooling

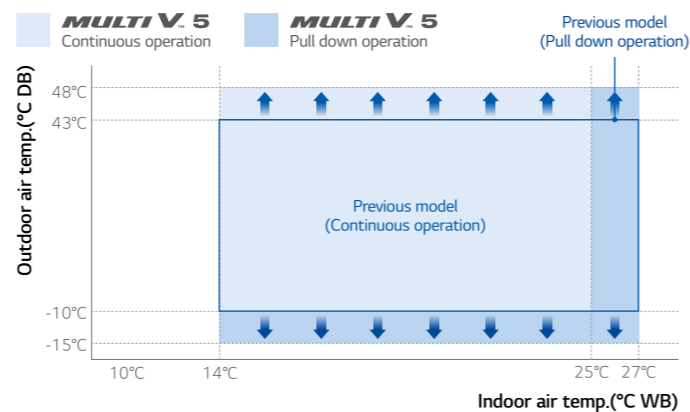

TROPICAL MODEL

Heating

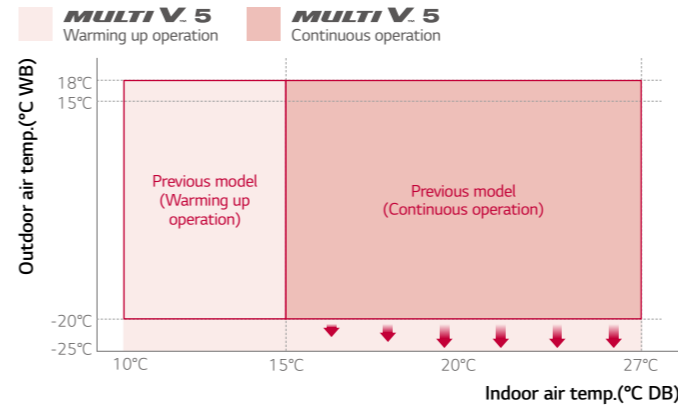

※ If it is not Tropical Model, please refer to the product spec sheet.

Cooling

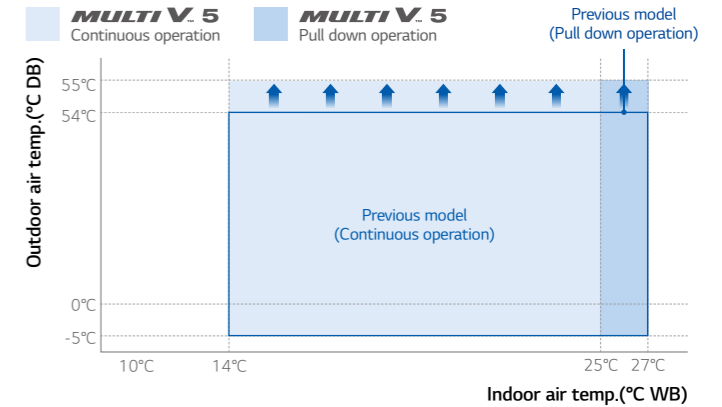

Simple Test Run via LGMV

Increased overall efficiency in installation

To make sure that the product functions properly, conducting a test run is recommended. For previous product, professional engineer who is well aware of more than 40 different functional settings and more than 200 error codes had to check main parts in order to make sure that the test run had succeeded. With Mobile LGMV of MULTI V 5, fast and accurate auto test run can be executed and the professional installer running the test can receive test results via email, which shortens installation hours and increases overall efficiency in installation processes.

Previous



MULTI V 5

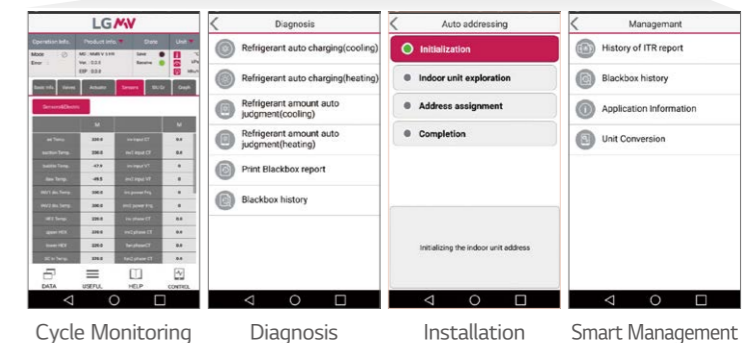
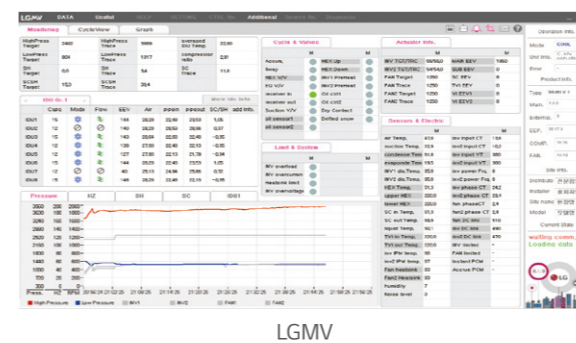

MULTI V 5

Non TROPICAL MODEL

HIGH EFFICIENCY

ARUM080LTE5 / ARUM100LTE5 / ARUM120LTE5 / ARUM140LTE5 / ARUM160LTE5



LG participates in the ECP programme for EUROVENT VRF program. Check ongoing validity of certification : www.eurovent-certification.com

HP			8	10	12	14	16
Model Name	Combination Unit		ARUM080LTE5	ARUM100LTE5	ARUM120LTE5	ARUM140LTE5	ARUM160LTE5
	Independent Unit		ARUM080LTE5	ARUM100LTE5	ARUM120LTE5	ARUM140LTE5	ARUM160LTE5
Capacity	Cooling (Rated)	kW	22.4	28.0	33.6	39.2	44.8
	Heating (Rated)	kW	22.4	28.0	33.6	39.2	44.8
	Heating (Max.)	kW	25.2	31.5	37.8	44.1	50.4
Input	Cooling (Rated)	kW	4.49	5.80	7.58	8.68	10.89
	Heating (Rated)	kW	3.97	4.92	6.85	8.13	10.28
	Heating (Max.)	kW	4.78	5.92	8.26	9.72	12.39
EER			4.99	4.83	4.43	4.52	4.11
ESEER			8.41	8.13	7.47	7.33	6.59
ESEER (SLC)			9.46	9.15	8.60	8.26	7.79
COP	COP (Rated)		5.64	5.69	4.91	4.82	4.36
	COP (Max.)		5.27	5.32	4.58	4.54	4.07
Casing Color			Warm Gray / Dawn Gray	Warm Gray / Dawn Gray	Warm Gray / Dawn Gray	Warm Gray / Dawn Gray	Warm Gray / Dawn Gray
Heat Exchanger			Ocean Black Fin	Ocean Black Fin	Ocean Black Fin	Ocean Black Fin	Ocean Black Fin
Compressor	Motor Output x Number	W x No.	4,200 x 1	5,300 x 1	5,300 x 1	5,300 x 1	5,300 x 1
	Type		Propeller fan	Propeller fan	Propeller fan	Propeller fan	Propeller fan
Fan	Air Flow Rate (High)	m ³ /min	240 x 1	240 x 1	240 x 1	320 x 1	320 x 1
	Drive		DC INVERTER	DC INVERTER	DC INVERTER	DC INVERTER	DC INVERTER
Liquid Pipe		mm (inch)	9.52 (3/8)	9.52 (3/8)	12.7 (1/2)	12.7 (1/2)	12.7 (1/2)
Low Pressure Gas Pipe		mm (inch)	19.05 (3/4)	22.2 (7/8)	28.58 (1-1/8)	28.58 (1-1/8)	28.58 (1-1/8)
High Pressure Gas Pipe		mm (inch)	15.88 (5/8)	19.05 (3/4)	19.05 (3/4)	22.2 (7/8)	22.2 (7/8)
Dimensions (W x H x D)		mm	(930 x 1,690 x 760) x 1	(930 x 1,690 x 760) x 1	(930 x 1,690 x 760) x 1	(1,240 x 1,690 x 760) x 1	(1,240 x 1,690 x 760) x 1
Net Weight		kg	198 x 1	215 x 1	215 x 1	237 x 1	237 x 1
Sound Pressure Level	Cooling	dB(A)	58.0	58.0	59.0	60.0	60.5
	Heating	dB(A)	59.0	59.0	60.0	61.0	61.5
Sound Power Level	Cooling	dB(A)	84.0	85.0	86.0	89.0	90.0
	Heating	dB(A)	87.0	88.0	89.0	93.0	94.0
Communication Cable		No. x mm ² (VCTF-SB)	2C x 1.0 - 1.5	2C x 1.0 - 1.5	2C x 1.0 - 1.5	2C x 1.0 - 1.5	2C x 1.0 - 1.5
Refrigerant	Refrigerant Name		R410A	R410A	R410A	R410A	R410A
	Precharged Amount in factory	kg	7.5	9.5	9.5	13.5	13.5
		lbs	16.5	20.9	20.9	29.8	29.8
	GWP		2,087.5	2,087.5	2,087.5	2,087.5	2,087.5
	t-CO ₂ eq		15.7	19.8	19.8	28.2	28.2
Control			Electronic Expansion Valve	Electronic Expansion Valve	Electronic Expansion Valve	Electronic Expansion Valve	Electronic Expansion Valve
Refrigerant Oil	Type		FVC68D (PVE)	FVC68D (PVE)	FVC68D (PVE)	FVC68D (PVE)	FVC68D (PVE)
	Charge	cc	3,900	3,900	3,900	3,900	3,900
Power Supply		∅, V, Hz	3, 380 - 415, 50	3, 380 - 415, 50	3, 380 - 415, 50	3, 380 - 415, 50	3, 380 - 415, 50
			3, 380, 60	3, 380, 60	3, 380, 60	3, 380, 60	3, 380, 60
Number of Maximum Connectable Indoor Units			13 (20)	16 (25)	20 (30)	23 (35)	26 (40)

※ This product contains Fluorinated Greenhouse Gases. (R410A)

Non TROPICAL MODEL

HIGH EFFICIENCY

ARUM180LTE5 / ARUM200LTE5 / ARUM220LTE5
ARUM221LTE5 / ARUM240LTE5



LG participates in the ECP programme for EUROVENT VRF program. Check ongoing validity of certification : www.eurovent-certification.com

HP			18	20	22	22'	24
Model Name	Combination Unit		ARUM180LTE5	ARUM200LTE5	ARUM220LTE5	ARUM221LTE5	ARUM240LTE5
	Independent Unit		ARUM180LTE5	ARUM200LTE5	ARUM220LTE5	ARUM120LTE5 ARUM100LTE5	ARUM240LTE5
Capacity	Cooling (Rated)	kW	50.4	56.0	61.6	61.6	67.2
	Heating (Rated)	kW	50.4	56.0	61.6	61.6	67.2
	Heating (Max.)	kW	56.7	63.0	69.3	69.3	74.3
Input	Cooling (Rated)	kW	10.91	12.77	15.70	13.4	17.40
	Heating (Rated)	kW	10.12	12.20	14.15	11.8	15.89
	Heating (Max.)	kW	11.94	14.69	16.76	14.2	18.80
EER			4.62	4.39	3.92	4.60	3.86
ESEER			7.40	7.03	6.68	7.76	6.57
ESEER (SLC)			8.11	7.70	7.87	8.84	8.05
COP	COP (Rated)		4.98	4.59	4.35	5.23	4.23
	COP (Max.)		4.75	4.29	4.13	4.89	3.95
Casing Color			Warm Gray / Dawn Gray	Warm Gray / Dawn Gray	Warm Gray / Dawn Gray	Warm Gray / Dawn Gray	Warm Gray / Dawn Gray
Heat Exchanger			Ocean Black Fin	Ocean Black Fin	Ocean Black Fin	Ocean Black Fin	Ocean Black Fin
Compressor	Motor Output x Number	W x No.	5,300 x 1 + 4,200 x 1	5,300 x 1 + 4,200 x 1	5,300 x 1 + 4,200 x 1	5,300 x 2	5,300 x 2
	Type		Propeller fan	Propeller fan	Propeller fan	Propeller fan	Propeller fan
Fan	Air Flow Rate (High)	m ³ /min	320 x 1	320 x 1	320 x 1	(240 x 1) + (240 x 1)	320 x 1
	Drive		DC INVERTER	DC INVERTER	DC INVERTER	DC INVERTER	DC INVERTER
Liquid Pipe		mm (inch)	15.88 (5/8)	15.88 (5/8)	15.88 (5/8)	15.88 (5/8)	15.88 (5/8)
Low Pressure Gas Pipe		mm (inch)	28.58 (1-1/8)	28.58 (1-1/8)	28.58 (1-1/8)	28.58 (1-1/8)	34.9 (1-3/8)
High Pressure Gas Pipe		mm (inch)	22.2 (7/8)	22.2 (7/8)	28.58 (1-1/8)	28.58 (1-1/8)	28.58 (1-1/8)
Dimensions (W x H x D)		mm	(1,240 x 1,690 x 760) x1	(1,240 x 1,690 x 760) x1	(1,240 x 1,690 x 760) x1	(930 x 1,690 x 760) x 1 + (930 x 1,690 x 760) x 1	(1,240 x 1,690 x 760) x1
Net Weight		kg	300 x 1	300 x 1	300 x 1	(215 x 1) + (215 x 1)	310 x 1
Sound Pressure Level	Cooling	dB(A)	61.0	62.0	64.5	61.5	65.0
	Heating	dB(A)	62.0	64.5	65.5	62.5	67.0
Sound Power Level	Cooling	dB(A)	92.0	93.0	93.0	88.5	95.0
	Heating	dB(A)	95.0	96.0	97.0	91.5	99.0
Communication Cable		No. x mm ² (VCTF-SB)	2C x 1.0 - 1.5	2C x 1.0 - 1.5	2C x 1.0 - 1.5	2C x 1.0 - 1.5	2C x 1.0 - 1.5
Refrigerant	Refrigerant Name		R410A	R410A	R410A	R410A	R410A
	Precharged Amount in factory	kg	16.0	16.0	16.0	19.0	17.0
		lbs	35.3	35.3	35.3	41.9	37.5
	GWP		2,087.5	2,087.5	2,087.5	2,087.5	2,087.5
	t-CO ₂ eq		33.4	33.4	33.4	39.7	35.5
Control			Electronic Expansion Valve	Electronic Expansion Valve	Electronic Expansion Valve	Electronic Expansion Valve	Electronic Expansion Valve
Refrigerant Oil	Type		FVC68D (PVE)	FVC68D (PVE)	FVC68D (PVE)	FVC68D (PVE)	FVC68D (PVE)
	Charge	cc	5,200	5,200	5,200	7,800	5,200
Power Supply		∅, V, Hz	3, 380 - 415, 50	3, 380 - 415, 50	3, 380 - 415, 50	3, 380 - 415, 50	3, 380 - 415, 50
			3, 380, 60	3, 380, 60	3, 380, 60	3, 380, 60	3, 380, 60
Number of Maximum Connectable Indoor Units			29 (45)	32 (50)	35 (44)	35 (44)	39 (48)

※ This product contains Fluorinated Greenhouse Gases. (R410A)

MULTI V 5

Non TROPICAL MODEL

HIGH EFFICIENCY

ARUM241LTE5 / ARUM260LTE5 / ARUM261LTE5
ARUM280LTE5 / ARUM300LTE5



LG participates in the ECP programme for EUROVENT VRF program. Check ongoing validity of certification : www.eurovent-certification.com

HP			24'	26	26'	28	30
Model Name	Combination Unit		ARUM241LTE5	ARUM260LTE5	ARUM261LTE5	ARUM280LTE5	ARUM300LTE5
	Independent Unit		ARUM120LTE5 ARUM120LTE5	ARUM260LTE5	ARUM140LTE5 ARUM120LTE5	ARUM160LTE5 ARUM120LTE5	ARUM180LTE5 ARUM120LTE5
Capacity	Cooling (Rated)	kW	67.2	72.8	72.8	78.4	84.0
	Heating (Rated)	kW	67.2	67.2	72.8	78.4	84.0
	Heating (Max.)	kW	75.6	74.3	81.9	88.2	94.5
		Btu/h	257,900	253,400	279,400	300,900	322,400
Input	Cooling (Rated)	kW	15.2	20.20	16.3	18.5	18.5
	Heating (Rated)	kW	13.7	15.99	15.0	17.1	17.0
	Heating (Max.)	kW	16.5	19.15	18.0	20.7	20.2
EER			4.43	3.60	4.48	4.24	4.54
ESEER			7.47	6.34	7.39	6.94	7.43
ESEER (SLC)			8.60	7.62	8.41	8.12	8.29
COP	COP (Rated)		4.91	4.20	4.86	4.58	4.95
	COP (Max.)		4.58	3.88	4.56	4.27	4.68
Casing Color			Warm Gray / Dawn Gray	Warm Gray / Dawn Gray	Warm Gray / Dawn Gray	Warm Gray / Dawn Gray	Warm Gray / Dawn Gray
Heat Exchanger			Ocean Black Fin	Ocean Black Fin	Ocean Black Fin	Ocean Black Fin	Ocean Black Fin
Compressor	Motor Output x Number	W x No.	5,300 x 2	5,300 x 2	5,300 x 2	5,300 x 2	(5,300 x 2) + (4,200 x 1)
	Type		Propeller fan	Propeller fan	Propeller fan	Propeller fan	Propeller fan
Fan	Air Flow Rate (High)	m ³ /min	(240 x 1) + (240 x 1)	320 x 1	(320 x 1) + (240 x 1)	(320 x 1) + (240 x 1)	(320 x 1) + (240 x 1)
	Drive		DC INVERTER	DC INVERTER	DC INVERTER	DC INVERTER	DC INVERTER
Liquid Pipe		mm (inch)	15.88 (5/8)	19.05 (3/4)	19.05 (3/4)	19.05 (3/4)	19.05 (3/4)
Low Pressure Gas Pipe		mm (inch)	34.9 (1-3/8)	34.9 (1-3/8)	34.9 (1-3/8)	34.9 (1-3/8)	34.9 (1-3/8)
High Pressure Gas Pipe		mm (inch)	28.58 (1-1/8)	28.58 (1-1/8)	28.58 (1-1/8)	28.58 (1-1/8)	28.58 (1-1/8)
Dimensions (W x H x D)		mm	(930 x 1,690 x 760) x 1 + (930 x 1,690 x 760) x 1	(1,240 x 1,690 x 760) x 1	(1,240 x 1,690 x 760) x 1 + (930 x 1,690 x 760) x 1	(1,240 x 1,690 x 760) x 1 + (930 x 1,690 x 760) x 1	(1,240 x 1,690 x 760) x 1 + (930 x 1,690 x 760) x 1
Net Weight		kg	(215 x 1) + (215 x 1)	310 x 1	(237 x 1) + (215 x 1)	(237 x 1) + (215 x 1)	(300 x 1) + (215 x 1)
Sound Pressure Level	Cooling	dB(A)	62.0	65.0	62.5	62.8	63.1
	Heating	dB(A)	63.0	67.0	63.5	63.8	64.1
Sound Power Level	Cooling	dB(A)	89.0	95.0	90.8	91.5	93.0
	Heating	dB(A)	92.0	99.0	94.5	95.2	96.0
Communication Cable		No. x mm ² (VCTF-SB)	2C x 1.0 - 1.5	2C x 1.0 - 1.5	2C x 1.0 - 1.5	2C x 1.0 - 1.5	2C x 1.0 - 1.5
Refrigerant	Refrigerant Name		R410A	R410A	R410A	R410A	R410A
	Precharged Amount in factory	kg	19.0	17.0	23.0	23.0	25.5
		lbs	41.9	37.5	50.7	50.7	56.2
	GWP		2,087.5	2,087.5	2,087.5	2,087.5	2,087.5
	t-CO ₂ eq		39.7	35.5	48.0	48.0	53.2
Control			Electronic Expansion Valve	Electronic Expansion Valve	Electronic Expansion Valve	Electronic Expansion Valve	Electronic Expansion Valve
Refrigerant Oil	Type		FVC68D (PVE)	FVC68D (PVE)	FVC68D (PVE)	FVC68D (PVE)	FVC68D (PVE)
	Charge	cc	7,800	5,200	7,800	7,800	9,100
Power Supply		∅, V, Hz	3, 380 - 415, 50	3, 380 - 415, 50	3, 380 - 415, 50	3, 380 - 415, 50	3, 380 - 415, 50
			3, 380, 60	3, 380, 60	3, 380, 60	3, 380, 60	3, 380, 60
Number of Maximum Connectable Indoor Units			39 (48)	42 (52)	42 (52)	45 (56)	49 (60)

※ This product contains Fluorinated Greenhouse Gases. (R410A)

Non TROPICAL MODEL

HIGH EFFICIENCY

ARUM320LTE5 / ARUM340LTE5 / ARUM360LTE5
ARUM380LTE5 / ARUM400LTE5



HP			32	34	36	38	40
Model Name	Combination Unit		ARUM320LTE5	ARUM340LTE5	ARUM360LTE5	ARUM380LTE5	ARUM400LTE5
	Independent Unit		ARUM200LTE5 ARUM120LTE5	ARUM220LTE5 ARUM120LTE5	ARUM240LTE5 ARUM120LTE5	ARUM240LTE5 ARUM140LTE5	ARUM240LTE5 ARUM160LTE5
Capacity	Cooling (Rated)	kW	89.6	95.2	100.8	106.4	112.0
	Heating (Rated)	kW	89.6	95.2	100.8	106.4	112.0
	Heating (Max.)	kW	100.8	107.1	112.1	118.4	124.7
		Btu/h	343,900	365,400	382,300	403,800	425,300
Input	Cooling (Rated)	kW	20.4	23.3	25.0	26.1	28.3
	Heating (Rated)	kW	19.1	21.0	22.7	24.0	26.2
	Heating (Max.)	kW	22.9	25.0	27.1	28.5	31.2
EER			4.40	4.09	4.04	4.08	3.96
ESEER			7.19	6.94	6.85	6.83	6.58
ESEER (SLC)			8.01	8.11	8.22	8.11	7.94
COP	COP (Rated)		4.70	4.53	4.43	4.43	4.28
	COP (Max.)		4.39	4.28	4.14	4.15	4.00
Casing Color			Warm Gray / Dawn Gray	Warm Gray / Dawn Gray	Warm Gray / Dawn Gray	Warm Gray / Dawn Gray	Warm Gray / Dawn Gray
Heat Exchanger			Ocean Black Fin	Ocean Black Fin	Ocean Black Fin	Ocean Black Fin	Ocean Black Fin
Compressor	Motor Output x Number	W x No.	(5,300 x 2) + (4,200 x 1)	(5,300 x 2) + (4,200 x 1)	5,300 x 3	5,300 x 3	5,300 x 3
	Type		Propeller fan	Propeller fan	Propeller fan	Propeller fan	Propeller fan
Fan	Air Flow Rate (High)	m ³ /min	(320 x 1) + (240 x 1)	(320 x 1) + (240 x 1)	(320 x 1) + (240 x 1)	320 x 2	320 x 2
	Drive		DC INVERTER	DC INVERTER	DC INVERTER	DC INVERTER	DC INVERTER
Liquid Pipe		mm (inch)	19.05 (3/4)	19.05 (3/4)	19.05 (3/4)	19.05 (3/4)	19.05 (3/4)
Low Pressure Gas Pipe		mm (inch)	34.9 (1-3/8)	34.9 (1-3/8)	41.3 (1-5/8)	41.3 (1-5/8)	41.3 (1-5/8)
High Pressure Gas Pipe		mm (inch)	28.58 (1-1/8)	28.58 (1-1/8)	28.58 (1-1/8)	34.9 (1-3/8)	34.9 (1-3/8)
Dimensions (W x H x D)		mm	(1,240 x 1,690 x 760) x 1 + (930 x 1,690 x 760) x 1	(1,240 x 1,690 x 760) x 1 + (930 x 1,690 x 760) x 1	(1,240 x 1,690 x 760) x 1 + (930 x 1,690 x 760) x 1	(1,240 x 1,690 x 760) x 2	(1,240 x 1,690 x 760) x 2
Net Weight		kg	(300 x 1) + (215 x 1)	(300 x 1) + (215 x 1)	(310 x 1) + (215 x 1)	(310 x 1) + (237 x 1)	(310 x 1) + (237 x 1)
Sound Pressure Level	Cooling	dB(A)	63.8	65.6	66.0	66.2	66.3
	Heating	dB(A)	65.8	66.6	67.8	68.0	68.1
Sound Power Level	Cooling	dB(A)	93.8	93.8	95.5	96.0	96.2
	Heating	dB(A)	96.8	97.6	99.4	100.0	100.2
Communication Cable		No. x mm ² (VCTF-SB)	2C x 1.0 - 1.5	2C x 1.0 - 1.5	2C x 1.0 - 1.5	2C x 1.0 - 1.5	2C x 1.0 - 1.5
Refrigerant	Refrigerant Name		R410A	R410A	R410A	R410A	R410A
	Precharged Amount in factory	kg	25.5	25.5	26.5	30.5	30.5
		lbs	56.2	56.2	58.4	67.2	67.2
	GWP		2,087.5	2,087.5	2,087.5	2,087.5	2,087.5
	t-CO ₂ eq		53.2	53.2	55.3	63.7	63.7
Control			Electronic Expansion Valve	Electronic Expansion Valve	Electronic Expansion Valve	Electronic Expansion Valve	Electronic Expansion Valve
Refrigerant Oil	Type		FVC68D (PVE)	FVC68D (PVE)	FVC68D (PVE)	FVC68D (PVE)	FVC68D (PVE)
	Charge	cc	9,100	9,100	9,100	9,100	9,100
Power Supply		∅, V, Hz	3, 380 - 415, 50	3, 380 - 415, 50	3, 380 - 415, 50	3, 380 - 415, 50	3, 380 - 415, 50
			3, 380, 60	3, 380, 60	3, 380, 60	3, 380, 60	3, 380, 60
Number of Maximum Connectable Indoor Units			52 (64)	55 (64)	58 (64)	61 (64)	64

※ This product contains Fluorinated Greenhouse Gases. (R410A)

MULTI V 5

Non TROPICAL MODEL

HIGH EFFICIENCY

ARUM420LTE5 / ARUM440LTE5 / ARUM460LTE5
ARUM480LTE5 / ARUM500LTE5



HP			42	44	46	48	50
Model Name	Combination Unit		ARUM420LTE5	ARUM440LTE5	ARUM460LTE5	ARUM480LTE5	ARUM500LTE5
	Independent Unit		ARUM240LTE5 ARUM180LTE5	ARUM240LTE5 ARUM200LTE5	ARUM240LTE5 ARUM220LTE5	ARUM240LTE5 ARUM240LTE5	ARUM240LTE5 ARUM140LTE5 ARUM120LTE5
Capacity	Cooling (Rated)	kW	117.6	123.2	128.8	134.4	140.0
	Heating (Rated)	kW	117.6	123.2	128.8	134.4	140.0
	Heating (Max.)	kW	131.0	137.3	143.6	148.5	156.2
		Btu/h	446,800	468,300	489,800	506,700	532,800
Input	Cooling (Rated)	kW	28.3	30.2	33.1	34.8	33.7
	Heating (Rated)	kW	26.0	28.1	30.0	31.8	30.9
	Heating (Max.)	kW	30.7	33.5	35.6	37.6	36.8
EER			4.15	4.08	3.89	3.86	4.16
ESEER			6.90	6.77	6.62	6.57	6.97
ESEER (SLC)			8.05	7.86	7.96	8.05	8.23
COP	COP (Rated)		4.52	4.39	4.29	4.23	4.54
	COP (Max.)		4.26	4.10	4.04	3.95	4.25
Casing Color			Warm Gray / Dawn Gray	Warm Gray / Dawn Gray	Warm Gray / Dawn Gray	Warm Gray / Dawn Gray	Warm Gray / Dawn Gray
Heat Exchanger			Ocean Black Fin	Ocean Black Fin	Ocean Black Fin	Ocean Black Fin	Ocean Black Fin
Compressor	Motor Output x Number	W x No.	(5,300 x 3) + (4,200 x 1)	(5,300 x 3) + (4,200 x 1)	(5,300 x 3) + (4,200 x 1)	5,300 x 4	5,300 x 4
	Type		Propeller fan	Propeller fan	Propeller fan	Propeller fan	Propeller fan
Fan	Air Flow Rate (High)	m ³ /min	320 x 2	320 x 2	320 x 2	320 x 2	(320 x 2) + (240 x 1)
	Drive		DC INVERTER	DC INVERTER	DC INVERTER	DC INVERTER	DC INVERTER
	Liquid Pipe	mm (inch)	19.05 (3/4)	19.05 (3/4)	19.05 (3/4)	19.05 (3/4)	19.05 (3/4)
Low Pressure Gas Pipe	mm (inch)	41.3 (1-5/8)	41.3 (1-5/8)	41.3 (1-5/8)	41.3 (1-5/8)	41.3 (1-5/8)	
High Pressure Gas Pipe	mm (inch)	34.9 (1-3/8)	34.9 (1-3/8)	34.9 (1-3/8)	34.9 (1-3/8)	34.9 (1-3/8)	
Dimensions (W x H x D)	mm	(1,240 x 1,690 x 760) x 2	(1,240 x 1,690 x 760) x 2	(1,240 x 1,690 x 760) x 2	(1,240 x 1,690 x 760) x 2	(1,240 x 1,690 x 760) x 2 + (930 x 1,690 x 760) x 1	
Net Weight	kg	(310 x 1) + (300 x 1)	(310 x 1) + (300 x 1)	(310 x 1) + (300 x 1)	310 x 2	(310 x 1) + (237 x 1) + (215 x 1)	
Sound Pressure Level	Cooling	dB(A)	66.5	66.8	67.8	68.0	67.0
	Heating	dB(A)	68.2	68.9	69.3	70.0	68.6
Sound Power Level	Cooling	dB(A)	96.8	97.1	97.1	98.0	96.4
	Heating	dB(A)	100.5	100.8	101.1	102.0	100.3
Communication Cable	No. x mm ² (VCTF-SB)	2C x 1.0 - 1.5	2C x 1.0 - 1.5	2C x 1.0 - 1.5	2C x 1.0 - 1.5	2C x 1.0 - 1.5	
Refrigerant	Refrigerant Name		R410A	R410A	R410A	R410A	R410A
	Precharged Amount in factory	kg	33.0	33.0	33.0	34.0	40.0
		lbs	72.8	72.8	72.8	75.0	88.2
	GWP		2,087.5	2,087.5	2,087.5	2,087.5	2,087.5
	t-CO ₂ eq		68.9	68.9	68.9	71.0	83.5
Control		Electronic Expansion Valve	Electronic Expansion Valve	Electronic Expansion Valve	Electronic Expansion Valve	Electronic Expansion Valve	
Refrigerant Oil	Type		FVC68D (PVE)	FVC68D (PVE)	FVC68D (PVE)	FVC68D (PVE)	FVC68D (PVE)
	Charge	cc	10,400	10,400	10,400	13,000	14,300
Power Supply	∅, V, Hz		3, 380 - 415, 50	3, 380 - 415, 50	3, 380 - 415, 50	3, 380 - 415, 50	3, 380 - 415, 50
			3, 380, 60	3, 380, 60	3, 380, 60	3, 380, 60	3, 380, 60
Number of Maximum Connectable Indoor Units			64	64	64	64	64

※ This product contains Fluorinated Greenhouse Gases. (R410A)

Non TROPICAL MODEL

HIGH EFFICIENCY

ARUM520LTE5 / ARUM540LTE5 / ARUM560LTE5
ARUM580LTE5 / ARUM600LTE5



HP			52	54	56	58	60
Model Name	Combination Unit		ARUM520LTE5	ARUM540LTE5	ARUM560LTE5	ARUM580LTE5	ARUM600LTE5
	Independent Unit		ARUM240LTE5 ARUM160LTE5 ARUM120LTE5	ARUM240LTE5 ARUM180LTE5 ARUM120LTE5	ARUM240LTE5 ARUM200LTE5 ARUM120LTE5	ARUM240LTE5 ARUM220LTE5 ARUM120LTE5	ARUM240LTE5 ARUM240LTE5 ARUM120LTE5
Capacity	Cooling (Rated)	kW	145.6	151.2	156.8	162.4	168.0
	Heating (Rated)	kW	145.6	151.2	156.8	162.4	168.0
	Heating (Max.)	kW	162.5	168.8	175.1	181.4	186.3
		Btu/h	554,300	575,800	597,300	618,800	635,700
Input	Cooling (Rated)	kW	35.9	35.9	37.8	40.7	42.4
	Heating (Rated)	kW	33.0	32.9	34.9	36.9	38.6
	Heating (Max.)	kW	39.4	39.0	41.7	43.8	45.9
EER			4.06	4.21	4.15	3.99	3.96
ESEER			6.76	7.02	6.91	6.78	6.73
ESEER (SLC)			8.08	8.17	8.01	8.08	8.15
COP	COP (Rated)		4.41	4.60	4.49	4.40	4.35
	COP (Max.)		4.12	4.33	4.19	4.14	4.06
Casing Color			Warm Gray / Dawn Gray	Warm Gray / Dawn Gray	Warm Gray / Dawn Gray	Warm Gray / Dawn Gray	Warm Gray / Dawn Gray
Heat Exchanger			Ocean Black Fin	Ocean Black Fin	Ocean Black Fin	Ocean Black Fin	Ocean Black Fin
Compressor	Motor Output x Number	W x No.	5,300 x 4	(5,300 x 4) + (4,200 x 1)	(5,300 x 4) + (4,200 x 1)	(5,300 x 4) + (4,200 x 1)	5,300 x 5
	Type		Propeller fan	Propeller fan	Propeller fan	Propeller fan	Propeller fan
Fan	Air Flow Rate (High)	m ³ /min	(320 x 2) + (240 x 1)	(320 x 2) + (240 x 1)	(320 x 2) + (240 x 1)	(320 x 2) + (240 x 1)	(320 x 2) + (240 x 1)
	Drive		DC INVERTER	DC INVERTER	DC INVERTER	DC INVERTER	DC INVERTER
	Liquid Pipe	mm (inch)	19.05 (3/4)	19.05 (3/4)	19.05 (3/4)	19.05 (3/4)	19.05 (3/4)
Low Pressure Gas Pipe	mm (inch)	41.3 (1-5/8)	41.3 (1-5/8)	41.3 (1-5/8)	41.3 (1-5/8)	41.3 (1-5/8)	
High Pressure Gas Pipe	mm (inch)	34.9 (1-3/8)	34.9 (1-3/8)	34.9 (1-3/8)	34.9 (1-3/8)	34.9 (1-3/8)	
Dimensions (W x H x D)	mm	(1,240 x 1,690 x 760) x 2 + (930 x 1,690 x 760) x 1	(1,240 x 1,690 x 760) x 2 + (930 x 1,690 x 760) x 1	(1,240 x 1,690 x 760) x 2 + (930 x 1,690 x 760) x 1	(1,240 x 1,690 x 760) x 2 + (930 x 1,690 x 760) x 1	(1,240 x 1,690 x 760) x 2 + (930 x 1,690 x 760) x 1	
Net Weight	kg	(310 x 1) + (237 x 1) + (215 x 1)	(310 x 1) + (300 x 1) + (215 x 1)	(310 x 1) + (300 x 1) + (215 x 1)	(310 x 1) + (300 x 1) + (215 x 1)	(310 x 2) + (215 x 1)	
Sound Pressure Level	Cooling	dB(A)	67.1	67.2	67.4	68.3	68.5
	Heating	dB(A)	68.7	68.8	69.5	69.8	70.4
Sound Power Level	Cooling	dB(A)	96.6	97.1	97.4	97.4	98.3
	Heating	dB(A)	100.5	100.8	101.0	101.4	102.2
Communication Cable	No. x mm ² (VCTF-SB)	2C x 1.0 - 1.5	2C x 1.0 - 1.5	2C x 1.0 - 1.5	2C x 1.0 - 1.5	2C x 1.0 - 1.5	
Refrigerant	Refrigerant Name		R410A	R410A	R410A	R410A	R410A
	Precharged Amount in factory	kg	40.0	42.5	42.5	42.5	43.5
		lbs	88.2	93.7	93.7	93.7	95.9
	GWP		2,087.5	2,087.5	2,087.5	2,087.5	2,087.5
	t-CO ₂ eq		83.5	88.7	88.7	88.7	90.8
Control		Electronic Expansion Valve	Electronic Expansion Valve	Electronic Expansion Valve	Electronic Expansion Valve	Electronic Expansion Valve	
Refrigerant Oil	Type		FVC68D (PVE)	FVC68D (PVE)	FVC68D (PVE)	FVC68D (PVE)	FVC68D (PVE)
	Charge	cc	13,000	14,300	14,300	14,300	14,300
Power Supply	∅, V, Hz		3, 380 - 415, 50	3, 380 - 415, 50	3, 380 - 415, 50	3, 380 - 415, 50	3, 380 - 415, 50
			3, 380, 60	3, 380, 60	3, 380, 60	3, 380, 60	3, 380, 60
Number of Maximum Connectable Indoor Units			64	64	64	64	64

※ This product contains Fluorinated Greenhouse Gases. (R410A)

MULTI V 5

Non TROPICAL MODEL

HIGH EFFICIENCY

ARUM620LTE5 / ARUM640LTE5 / ARUM660LTE5
ARUM680LTE5 / ARUM700LTE5 / ARUM720LTE5



HP			62	64	66	68	70	72
Model Name	Combination Unit		ARUM620LTE5	ARUM640LTE5	ARUM660LTE5	ARUM680LTE5	ARUM700LTE5	ARUM720LTE5
	Independent Unit		ARUM240LTE5 ARUM240LTE5 ARUM140LTE5	ARUM240LTE5 ARUM240LTE5 ARUM160LTE5	ARUM240LTE5 ARUM240LTE5 ARUM180LTE5	ARUM240LTE5 ARUM240LTE5 ARUM200LTE5	ARUM240LTE5 ARUM240LTE5 ARUM220LTE5	ARUM240LTE5 ARUM240LTE5 ARUM240LTE5
Capacity	Cooling (Rated)	kW	173.6	179.2	184.8	190.4	196.0	201.6
	Heating (Rated)	kW	173.6	179.2	184.8	190.4	196.0	201.6
	Heating (Max.)	kW	192.6	198.9	205.2	211.5	217.8	222.8
		Btu/h	657,200	678,700	700,200	721,700	743,200	760,100
Input	Cooling (Rated)	kW	43.5	45.7	45.7	47.6	50.5	52.2
	Heating (Rated)	kW	39.9	42.1	41.9	44.0	45.9	47.7
	Heating (Max.)	kW	47.3	50.0	49.5	52.3	54.4	56.4
EER			3.99	3.92	4.04	4.00	3.88	3.86
ESEER			6.73	6.58	6.78	6.70	6.60	6.57
ESEER (SLC)			8.09	7.98	8.05	7.92	7.99	8.05
COP	COP (Rated)		4.35	4.26	4.41	4.33	4.27	4.23
	COP (Max.)		4.07	3.98	4.14	4.05	3.98	3.95
Casing Color			Warm Gray / Dawn Gray	Warm Gray / Dawn Gray	Warm Gray / Dawn Gray	Warm Gray / Dawn Gray	Warm Gray / Dawn Gray	Warm Gray / Dawn Gray
Heat Exchanger			Ocean Black Fin	Ocean Black Fin	Ocean Black Fin	Ocean Black Fin	Ocean Black Fin	Ocean Black Fin
Compressor	Motor Output x Number	W x No.	5,300 x 5	5,300 x 5	(5,300 x 5) + (4,200 x 1)	(5,300 x 5) + (4,200 x 1)	(5,300 x 5) + (4,200 x 1)	5,300 x 6
	Type		Propeller fan	Propeller fan	Propeller fan	Propeller fan	Propeller fan	Propeller fan
Fan	Air Flow Rate (High)	m ³ /min	320 x 3	320 x 3	320 x 3	320 x 3	320 x 3	320 x 3
	Drive		DC INVERTER	DC INVERTER	DC INVERTER	DC INVERTER	DC INVERTER	DC INVERTER
Liquid Pipe	mm (inch)	22.2 (7/8)	22.2 (7/8)	22.2 (7/8)	22.2 (7/8)	22.2 (7/8)	22.2 (7/8)	
Low Pressure Gas Pipe	mm (inch)	44.5 (1-3/4)	44.5 (1-3/4)	53.98 (2-1/8)	53.98 (2-1/8)	53.98 (2-1/8)	53.98 (2-1/8)	
High Pressure Gas Pipe	mm (inch)	41.3 (1-5/8)	41.3 (1-5/8)	44.5 (1-3/4)	44.5 (1-3/4)	44.5 (1-3/4)	44.5 (1-3/4)	
Dimensions (W x H x D)	mm	(1,240 x 1,690 x 760) x 3	(1,240 x 1,690 x 760) x 3	(1,240 x 1,690 x 760) x 3	(1,240 x 1,690 x 760) x 3	(1,240 x 1,690 x 760) x 3	(1,240 x 1,690 x 760) x 3	
Net Weight	kg	(310 x 2) + (237 x 1)	(310 x 2) + (237 x 1)	(310 x 2) + (300 x 1)	(310 x 2) + (300 x 1)	(310 x 2) + (300 x 1)	310 x 3	
Sound Pressure Level	Cooling	dB(A)	68.6	68.7	68.8	69.0	69.6	69.8
	Heating	dB(A)	70.5	70.6	70.6	71.1	71.3	71.8
Sound Power Level	Cooling	dB(A)	98.5	98.6	99.0	99.2	99.2	99.8
	Heating	dB(A)	102.5	102.6	102.8	103.0	103.0	103.8
Communication Cable	No. x mm ² (VCTF-SB)	2C x 1.0 - 1.5	2C x 1.0 - 1.5	2C x 1.0 - 1.5	2C x 1.0 - 1.5	2C x 1.0 - 1.5	2C x 1.0 - 1.5	
Refrigerant	Refrigerant Name		R410A	R410A	R410A	R410A	R410A	R410A
	Precharged Amount in factory	kg	47.5	47.5	50.0	50.0	50.0	51.0
		lbs	104.7	104.7	110.2	110.2	110.2	112.4
	GWP		2,087.5	2,087.5	2,087.5	2,087.5	2,087.5	2,087.5
	t-CO ₂ eq		99.2	99.2	104.4	104.4	104.4	106.5
Control		Electronic Expansion Valve	Electronic Expansion Valve	Electronic Expansion Valve	Electronic Expansion Valve	Electronic Expansion Valve	Electronic Expansion Valve	
Refrigerant Oil	Type		FVC68D (PVE)	FVC68D (PVE)	FVC68D (PVE)	FVC68D (PVE)	FVC68D (PVE)	FVC68D (PVE)
	Charge	cc	14,300	14,300	15,600	15,600	15,600	15,600
Power Supply	∅, V, Hz		3, 380 - 415, 50	3, 380 - 415, 50	3, 380 - 415, 50	3, 380 - 415, 50	3, 380 - 415, 50	3, 380 - 415, 50
			3, 380, 60	3, 380, 60	3, 380, 60	3, 380, 60	3, 380, 60	3, 380, 60
Number of Maximum Connectable Indoor Units			64	64	64	64	64	64

※ This product contains Fluorinated Greenhouse Gases. (R410A)

Non TROPICAL MODEL

HIGH EFFICIENCY

ARUM740LTE5 / ARUM760LTE5 / ARUM780LTE5
ARUM800LTE5 / ARUM820LTE5 / ARUM840LTE5



HP			74	76	78	80	82	84
Model Name	Combination Unit		ARUM740LTE5	ARUM760LTE5	ARUM780LTE5	ARUM800LTE5	ARUM820LTE5	ARUM840LTE5
	Independent Unit		ARUM240LTE5 ARUM240LTE5 ARUM140LTE5 ARUM120LTE5	ARUM240LTE5 ARUM240LTE5 ARUM160LTE5 ARUM120LTE5	ARUM240LTE5 ARUM240LTE5 ARUM180LTE5 ARUM120LTE5	ARUM240LTE5 ARUM240LTE5 ARUM200LTE5 ARUM120LTE5	ARUM240LTE5 ARUM240LTE5 ARUM220LTE5 ARUM120LTE5	ARUM240LTE5 ARUM240LTE5 ARUM240LTE5 ARUM120LTE5
Capacity	Cooling (Rated)	kW	207.2	212.8	218.4	224.0	229.6	235.2
	Heating (Rated)	kW	207.2	212.8	218.4	224.0	229.6	235.2
	Heating (Max.)	kW	230.4	236.7	243.0	249.3	255.6	260.6
		Btu/h	786,200	807,700	829,200	850,700	872,100	889,100
Input	Cooling (Rated)	kW	51.1	53.3	53.3	55.2	58.1	59.8
	Heating (Rated)	kW	46.8	48.9	48.8	50.8	52.8	54.5
	Heating (Max.)	kW	55.6	58.2	57.8	60.5	62.6	64.7
EER			4.06	3.99	4.10	4.06	3.95	3.93
ESEER			6.84	6.70	6.88	6.80	6.72	6.69
ESEER (SLC)			8.17	8.07	8.13	8.02	8.07	8.12
COP	COP (Rated)		4.43	4.35	4.48	4.41	4.35	4.31
	COP (Max.)		4.15	4.06	4.20	4.12	4.08	4.03
Casing Color			Warm Gray / Dawn Gray	Warm Gray / Dawn Gray	Warm Gray / Dawn Gray	Warm Gray / Dawn Gray	Warm Gray / Dawn Gray	Warm Gray / Dawn Gray
Heat Exchanger			Ocean Black Fin	Ocean Black Fin	Ocean Black Fin	Ocean Black Fin	Ocean Black Fin	Ocean Black Fin
Compressor	Motor Output x Number	W x No.	5,300 x 6	5,300 x 6	(5,300 x 6) + (4,200 x 1)	(5,300 x 6) + (4,200 x 1)	(5,300 x 6) + (4,200 x 1)	5,300 x 7
	Type		Propeller fan	Propeller fan	Propeller fan	Propeller fan	Propeller fan	Propeller fan
Fan	Air Flow Rate (High)	m ³ /min	(320 x 3) + (240 x 1)	(320 x 3) + (240 x 1)	(320 x 3) + (240 x 1)	(320 x 3) + (240 x 1)	(320 x 3) + (240 x 1)	(320 x 3) + (240 x 1)
	Drive		DC INVERTER	DC INVERTER	DC INVERTER	DC INVERTER	DC INVERTER	DC INVERTER
Liquid Pipe	mm (inch)	22.2 (7/8)	22.2 (7/8)	22.2 (7/8)	22.2 (7/8)	22.2 (7/8)	22.2 (7/8)	
Low Pressure Gas Pipe	mm (inch)	53.98 (2-1/8)	53.98 (2-1/8)	53.98 (2-1/8)	53.98 (2-1/8)	53.98 (2-1/8)	53.98 (2-1/8)	
High Pressure Gas Pipe	mm (inch)	44.5 (1-3/4)	44.5 (1-3/4)	44.5 (1-3/4)	44.5 (1-3/4)	44.5 (1-3/4)	44.5 (1-3/4)	
Dimensions (W x H x D)	mm	(1,240 x 1,690 x 760) x 3 + (930 x 1,690 x 760) x 1	(1,240 x 1,690 x 760) x 3 + (930 x 1,690 x 760) x 1	(1,240 x 1,690 x 760) x 3 + (930 x 1,690 x 760) x 1	(1,240 x 1,690 x 760) x 3 + (930 x 1,690 x 760) x 1	(1,240 x 1,690 x 760) x 3 + (930 x 1,690 x 760) x 1	(1,240 x 1,690 x 760) x 3 + (930 x 1,690 x 760) x 1	
Net Weight	kg	(310 x 2) + (237 x 1) + (215 x 1)	(310 x 2) + (237 x 1) + (215 x 1)	(310 x 2) + (300 x 1) + (215 x 1)	(310 x 2) + (300 x 1) + (215 x 1)	(310 x 2) + (300 x 1) + (215 x 1)	(310 x 3) + (215 x 1)	
Sound Pressure Level	Cooling	dB(A)	69.1	69.2	69.2	69.4	70.0	70.1
	Heating	dB(A)	70.9	70.9	71.0	71.4	71.6	72.1
Sound Power Level	Cooling	dB(A)	98.8	98.9	99.2	99.4	99.4	99.9
	Heating	dB(A)	102.7	102.8	103.0	103.2	103.4	103.9
Communication Cable	No. x mm ² (VCTF-SB)	2C x 1.0 - 1.5	2C x 1.0 - 1.5	2C x 1.0 - 1.5	2C x 1.0 - 1.5	2C x 1.0 - 1.5	2C x 1.0 - 1.5	
Refrigerant	Refrigerant Name		R410A	R410A	R410A	R410A	R410A	R410A
	Precharged Amount in factory	kg	57.0	57.0	59.5	59.5	59.5	60.5
		lbs	125.7	125.7	131.2	131.2	131.2	133.4
	GWP		2,087.5	2,087.5	2,087.5	2,087.5	2,087.5	2,087.5
	t-CO ₂ eq		119.0	119.0	124.2	124.2	124.2	126.3
Control		Electronic Expansion Valve	Electronic Expansion Valve	Electronic Expansion Valve	Electronic Expansion Valve	Electronic Expansion Valve	Electronic Expansion Valve	
Refrigerant Oil	Type		FVC68D (PVE)	FVC68D (PVE)	FVC68D (PVE)	FVC68D (PVE)	FVC68D (PVE)	FVC68D (PVE)
	Charge	cc	18,200	18,200	19,500	19,500	19,500	19,500
Power Supply	∅, V, Hz		3, 380 - 415, 50	3, 380 - 415, 50	3, 380 - 415, 50	3, 380 - 415, 50	3, 380 - 415, 50	3, 380 - 415, 50
			3, 380, 60	3, 380, 60	3, 380, 60	3, 380, 60	3, 380, 60	3, 380, 60
Number of Maximum Connectable Indoor Units			64	64	64	64	64	64

※ This product contains Fluorinated Greenhouse Gases. (R410A)

MULTI V 5

Non TROPICAL MODEL

HIGH EFFICIENCY

ARUM860LTE5 / ARUM880LTE5 / ARUM900LTE5
ARUM920LTE5 / ARUM940LTE5 / ARUM960LTE5



HP			86	88	90	92	94	96
Model Name	Combination Unit		ARUM860LTE5	ARUM880LTE5	ARUM900LTE5	ARUM920LTE5	ARUM940LTE5	ARUM960LTE5
	Independent Unit		ARUM240LTE5 ARUM240LTE5 ARUM240LTE5 ARUM140LTE5	ARUM240LTE5 ARUM240LTE5 ARUM240LTE5 ARUM160LTE5	ARUM240LTE5 ARUM240LTE5 ARUM240LTE5 ARUM180LTE5	ARUM240LTE5 ARUM240LTE5 ARUM240LTE5 ARUM200LTE5	ARUM240LTE5 ARUM240LTE5 ARUM240LTE5 ARUM220LTE5	ARUM240LTE5 ARUM240LTE5 ARUM240LTE5 ARUM240LTE5
Capacity	Cooling (Rated)	kW	240.8	246.4	252.0	257.6	263.2	268.8
	Heating (Rated)	kW	240.8	246.4	252.0	257.6	263.2	268.8
	Heating (Max.)	kW	266.9	273.2	279.5	285.8	292.1	297.0
		Btu/h	910,600	932,000	953,500	975,000	996,500	1,013,400
Input	Cooling (Rated)	kW	60.9	63.1	63.1	65.0	67.9	69.6
	Heating (Rated)	kW	55.8	58.0	57.8	59.9	61.8	63.6
	Heating (Max.)	kW	66.1	68.8	68.3	71.1	73.2	75.2
EER			3.96	3.91	3.99	3.96	3.88	3.86
ESEER			6.68	6.57	6.72	6.66	6.60	6.57
ESEER (SLC)			8.07	8.00	8.04	7.95	8.00	8.05
COP	COP (Rated)		4.32	4.25	4.36	4.30	4.26	4.23
	COP (Max.)		4.04	3.97	4.09	4.02	3.99	3.95
Casing Color			Warm Gray / Dawn Gray	Warm Gray / Dawn Gray	Warm Gray / Dawn Gray	Warm Gray / Dawn Gray	Warm Gray / Dawn Gray	Warm Gray / Dawn Gray
Heat Exchanger			Ocean Black Fin	Ocean Black Fin	Ocean Black Fin	Ocean Black Fin	Ocean Black Fin	Ocean Black Fin
Compressor	Motor Output x Number	W x No.	5,300 x 7	5,300 x 7	(5,300 x 7) + (4,200 x 1)	(5,300 x 7) + (4,200 x 1)	(5,300 x 7) + (4,200 x 1)	5,300 x 8
	Type		Propeller fan	Propeller fan	Propeller fan	Propeller fan	Propeller fan	Propeller fan
Fan	Air Flow Rate (High)	m ³ /min	320 x 4	320 x 4	320 x 4	320 x 4	320 x 4	320 x 4
	Drive		DC INVERTER	DC INVERTER	DC INVERTER	DC INVERTER	DC INVERTER	DC INVERTER
Liquid Pipe		mm (inch)	22.2 (7/8)	22.2 (7/8)	22.2 (7/8)	22.2 (7/8)	22.2 (7/8)	22.2 (7/8)
Low Pressure Gas Pipe		mm (inch)	53.98 (2-1/8)	53.98 (2-1/8)	53.98 (2-1/8)	53.98 (2-1/8)	53.98 (2-1/8)	53.98 (2-1/8)
High Pressure Gas Pipe		mm (inch)	44.5 (1-3/4)	44.5 (1-3/4)	44.5 (1-3/4)	44.5 (1-3/4)	44.5 (1-3/4)	44.5 (1-3/4)
Dimensions (W x H x D)		mm	(1,240 x 1,690 x 760) x 4	(1,240 x 1,690 x 760) x 4	(1,240 x 1,690 x 760) x 4	(1,240 x 1,690 x 760) x 4	(1,240 x 1,690 x 760) x 4	(1,240 x 1,690 x 760) x 4
Net Weight		kg	(310 x 3) + (237 x 1)	(310 x 3) + (237 x 1)	(310 x 3) + (300 x 1)	(310 x 3) + (300 x 1)	(310 x 3) + (300 x 1)	310 x 4
Sound Pressure Level	Cooling	dB(A)	70.2	70.3	70.3	70.4	70.9	71.0
	Heating	dB(A)	72.1	72.2	72.2	72.5	72.7	73.0
Sound Power Level	Cooling	dB(A)	101.1	100.2	100.4	100.6	100.6	101.0
	Heating	dB(A)	104.1	104.2	104.3	104.4	104.6	105.0
Communication Cable		No. x mm ² (VCTF-SB)	2C x 1.0 - 1.5	2C x 1.0 - 1.5	2C x 1.0 - 1.5	2C x 1.0 - 1.5	2C x 1.0 - 1.5	2C x 1.0 - 1.5
Refrigerant	Refrigerant Name		R410A	R410A	R410A	R410A	R410A	R410A
	Precharged Amount in factory	kg	64.5	64.5	67.0	67.0	67.0	68.0
		lbs	142.2	142.2	147.7	147.7	147.7	149.9
	GWP		2,087.5	2,087.5	2,087.5	2,087.5	2,087.5	2,087.5
	t-CO ₂ eq		134.6	134.6	139.9	139.9	139.9	142.0
Control			Electronic Expansion Valve	Electronic Expansion Valve	Electronic Expansion Valve	Electronic Expansion Valve	Electronic Expansion Valve	Electronic Expansion Valve
Refrigerant Oil	Type		FVC68D (PVE)	FVC68D (PVE)	FVC68D (PVE)	FVC68D (PVE)	FVC68D (PVE)	FVC68D (PVE)
	Charge	cc	19,500	19,500	20,800	20,800	20,800	20,800
Power Supply			3, 380 - 415, 50	3, 380 - 415, 50	3, 380 - 415, 50	3, 380 - 415, 50	3, 380 - 415, 50	3, 380 - 415, 50
			3, 380, 60	3, 380, 60	3, 380, 60	3, 380, 60	3, 380, 60	3, 380, 60
Number of Maximum Connectable Indoor Units			64	64	64	64	64	64

NOTE

1. Eurovent Test Condition : For more info regarding program consult www.eurovent-certification.com
2. Capacities are based on the following conditions :
 - Cooling Temperature : Indoor 27°C(80.6°F) DB / 19°C(66.2°F) WB, Outdoor 35°C(95°F) DB / 24°C(75.2°F) WB
 - Heating Temperature : Indoor 20°C(68°F) DB / 15°C(59°F) WB, Outdoor 7°C(44.6°F) DB / 6°C(42.8°F) WB
 - Piping Length : Interconnected Pipe Length = 7.5m
 - Difference Limit of Elevation (Outdoor - Indoor Unit) is Zero.
3. Wiring cable size must comply with the applicable local and national code.
4. Sound Level Values can be increased owing to ambient conditions during operation.
5. The numbers in parentheses means maximum connectable indoor units in accordance with outdoor units combination. The recommended ratio is 130%.
6. ESEER calculation corresponds with below conditions and power input of indoor units is not included.
 - Indoor temperature : 27°C(80.6°F) DB / 19°C(66.2°F) WB
 - Outdoor temperature conditions.

Part Load Ratio	Outdoor Air Temp. (°C (°F)DB)	Weighting Coefficients
100%	35 (95)	0.03
75%	30 (86)	0.33
50%	25 (77)	0.41
25%	20 (68)	0.23

• Formula : 0.03 x EER100% + 0.33 x EER75% + 0.41 x EER50% + 0.23 x EER25%

7. Due to our policy of innovation some specifications may be changed without notification.
8. Power factor could vary less than 1% according to the operating conditions.
9. This product contains fluorinated greenhouse gases.

※ This product contains Fluorinated Greenhouse Gases. (R410A)

MULTI V 5

Non TROPICAL MODEL

STANDARD

ARUN080LTE5 / ARUN100LTE5 / ARUN120LTE5 / ARUN140LTE5

 LG participates in the ECP programme for EUROVENT VRF program. Check ongoing validity of certification : www.eurovent-certification.com



HP			8	10	12	14
Model Name	Combination Unit		ARUN080LTE5	ARUN100LTE5	ARUN120LTE5	ARUN140LTE5
	Independent Unit		ARUN080LTE5	ARUN100LTE5	ARUN120LTE5	ARUN140LTE5
Capacity	Cooling (Rated)	kW	22.4	28.0	33.6	39.2
		Btu/h	76,400	95,500	114,600	133,800
	Heating (Rated)	kW	25.2	31.5	37.8	44.1
		Btu/h	86,000	107,500	129,000	150,500
Input	Cooling (Rated)	kW	4.59	5.70	7.91	9.12
	Heating (Rated)	kW	4.74	5.78	8.06	9.78
Input	Cooling (Rated)	kW	4.99	6.45	8.42	10.21
	Heating (Rated)	kW	4.27	5.29	7.37	9.03
	Heating (Max.)	kW	5.14	6.37	8.89	10.80
EER (Rated)			4.88	4.91	4.25	4.30
COP (Rated)			5.32	5.45	4.69	4.51
EER			4.49	4.34	3.99	3.84
ESEER			7.57	7.31	6.72	6.23
ESEER (SLC)			8.51	8.23	7.74	7.03
Power Factor	Rated	-	0.93	0.93	0.93	0.93
Exterior	Color		Warm Gray / Dawn Gray	Warm Gray / Dawn Gray	Warm Gray / Dawn Gray	Warm Gray / Dawn Gray
	RAL code		NL503K / NA507K	NL503K / NA507K	NL503K / NA507K	NL503K / NA507K
Heat Exchanger			Wide Louver Plus	Wide Louver Plus	Wide Louver Plus	Wide Louver Plus
Compressor	Motor Output x Number	W x No.	5,300 x 1	5,300 x 1	5,300 x 1	5,300 x 1
	Type		Propeller fan	Propeller fan	Propeller fan	Propeller fan
Fan	Motor Output x Number	W	1,200 x 1	1,200 x 1	1,200 x 1	900 x 2
	Air Flow Rate (High)	m³/min	240 x 1	240 x 1	240 x 1	320 x 1
		ft³/min	8,476 x 1	8,476 x 1	8,476 x 1	11,301 x 1
	External Static Pressure (Max, Pa)		80	80	80	80
	Drive		DC INVERTER	DC INVERTER	DC INVERTER	DC INVERTER
Discharge	Side / Top	TOP	TOP	TOP	TOP	
Pipe Connctions	Liquid Pipe	mm (inch)	9.52 (3/8)	9.52 (3/8)	12.7 (1/2)	12.7 (1/2)
	Gas Pipe	mm (inch)	19.05 (3/4)	22.2 (7/8)	28.58 (1-1/8)	28.58 (1-1/8)
Dimensions (W x H x D)	mm	(930 x 1,690 x 760) x 1	(930 x 1,690 x 760) x 1	(930 x 1,690 x 760) x 1	(1,240 x 1,690 x 760) x 1	
Net Weight	kg	199 x 1	199 x 1	199 x 1	221 x 1	
	lbs	439 x 1	439 x 1	439 x 1	487 x 1	
Sound Pressure Level	Cooling	dB(A)	58.0	58.0	59.0	60.0
	Heating	dB(A)	59.0	59.0	60.0	61.0
Sound Power Level	Cooling	dB(A)	78.0	78.0	79.0	82.0
	Heating	dB(A)	79.0	79.0	80.0	84.0
Communication Cable	No. x mm² (VCTF-SB)	2C x 1.0 - 1.5	2C x 1.0 - 1.5	2C x 1.0 - 1.5	2C x 1.0 - 1.5	
Refrigerant	Refrigerant Name		R410A	R410A	R410A	R410A
	Precharged Amount in factory	kg	10.0	10.0	10.0	13.0
		lbs	22.0	22.0	22.0	28.7
	t-CO ₂ eq		20.9	20.9	20.9	27.1
	Control		Electronic Expansion Valve	Electronic Expansion Valve	Electronic Expansion Valve	Electronic Expansion Valve
Power Supply	Ø, V, Hz		3, 380 - 415, 50	3, 380 - 415, 50	3, 380 - 415, 50	3, 380 - 415, 50
			3, 380, 60	3, 380, 60	3, 380, 60	3, 380, 60
Number of Maxmum Connectable Indoor Units			13 (20)	16 (25)	20 (30)	23 (35)

- Note : 1. Due to our policy of innovation some specifications may be changed without notification.
 2. Wiring cable size must comply with the applicable local and national codes. And "Electric characteristics" chapter should be considered for electrical work and design. Especially the power cable and circuit breaker should be selected in accordance with that.
 3. Power factor could vary less than ±1% according to the operating conditions.
 4. Sound pressure level is measured on the rated condition in the anechoic rooms by ISO 3745 standard. Sound power level is measured on the rated condition in the reverberation rooms by ISO 3741 standard. Therefore, these values can be increased owing to ambient conditions during operation.
 5. Performances are based on the following conditions : Cooling : Indoor Ambient Temp. 27°CDB / 19°CWB, Outdoor Ambient Temp. 35°CDB / 24°CWB
 Heating : Indoor Ambient Temp. 20°CDB / 15°CWB, Outdoor Ambient Temp. 7°CDB / 6°CWB
 Interconnected Pipe Length is 7.5m and difference of Elevation (Outdoor - Indoor Unit) is Zero.
 6. The numbers in parentheses means maximum connectable indoor units in accordance with outdoor units combination. The recommended ratio is 130%.
 7. This product contains Fluorinated greenhouse gases.(R410A, GWP(Global warming potential) = 2087.5)
 ※ Eurovent test Condition

Non TROPICAL MODEL

STANDARD

ARUN160LTE5 / ARUN180LTE5 / ARUN200LTE5 / ARUN220LTE5

 LG participates in the ECP programme for EUROVENT VRF program. Check ongoing validity of certification : www.eurovent-certification.com



HP			16	18	20	22
Model Name	Combination Unit		ARUN160LTE5	ARUN180LTE5	ARUN200LTE5	ARUN220LTE5
	Independent Unit		ARUN160LTE5	ARUN180LTE5	ARUN200LTE5	ARUN220LTE5
Capacity	Cooling (Rated)	kW	44.8	50.4	56.0	61.6
		Btu/h	152,900	172,000	191,100	210,200
	Heating (Rated)	kW	50.4	56.7	63.0	69.3
		Btu/h	172,000	193,500	215,000	236,500
Input	Cooling (Rated)	kW	10.80	10.96	12.31	14.84
	Heating (Rated)	kW	11.59	12.06	15.52	17.54
Input	Cooling (Rated)	kW	12.80	12.82	15.01	18.44
	Heating (Rated)	kW	11.43	11.25	13.56	15.71
	Heating (Max.)	kW	13.77	13.27	16.32	18.62
EER (Rated)			4.15	4.60	4.55	4.15
COP (Rated)			4.35	4.70	4.06	3.95
EER			3.50	3.93	3.73	3.34
ESEER			5.61	6.30	5.98	5.68
ESEER (SLC)			6.63	6.90	6.55	6.70
Power Factor	Rated	-	0.93	0.93	0.93	0.93
Exterior	Color		Warm Gray / Dawn Gray	Warm Gray / Dawn Gray	Warm Gray / Dawn Gray	Warm Gray / Dawn Gray
	RAL code		NL503K / NA507K	NL503K / NA507K	NL503K / NA507K	NL503K / NA507K
Heat Exchanger			Wide Louver Plus	Wide Louver Plus	Wide Louver Plus	Wide Louver Plus
Compressor	Motor Output x Number	W x No.	5,300 x 1	5,300 x 1 + 4,200 x 1	5,300 x 2	5,300 x 2
	Type		Propeller fan	Propeller fan	Propeller fan	Propeller fan
Fan	Motor Output x Number	W	900 x 2	900 x 2	900 x 2	900 x 2
	Air Flow Rate (High)	m³/min	320 x 1	320 x 1	320 x 1	320 x 1
		ft³/min	11,301 x 1	11,301 x 1	11,301 x 1	11,301 x 1
	External Static Pressure (Max, Pa)		80	80	80	80
	Drive		DC INVERTER	DC INVERTER	DC INVERTER	DC INVERTER
Discharge	Side / Top	TOP	TOP	TOP	TOP	
Pipe Connctions	Liquid Pipe	mm (inch)	12.7 (1/2)	15.88 (5/8)	15.88 (5/8)	15.88 (5/8)
	Gas Pipe	mm (inch)	28.58 (1-1/8)	28.58 (1-1/8)	28.58 (1-1/8)	28.58 (1-1/8)
Dimensions (W x H x D)	mm	(1,240 x 1,690 x 760) x 1	(1,240 x 1,690 x 760) x 1	(1,240 x 1,690 x 760) x 1	(1,240 x 1,690 x 760) x 1	
Net Weight	kg	221 x 1	261 x 1	281 x 1	281 x 1	
	lbs	487 x 1	575 x 1	619 x 1	619 x 1	
Sound Pressure Level	Cooling	dB(A)	60.5	61.0	62.0	64.5
	Heating	dB(A)	61.5	62.0	64.5	65.5
Sound Power Level	Cooling	dB(A)	83.0	85.0	86.0	86.0
	Heating	dB(A)	85.0	86.0	87.0	88.0
Communication Cable	No. x mm² (VCTF-SB)	2C x 1.0 - 1.5	2C x 1.0 - 1.5	2C x 1.0 - 1.5	2C x 1.0 - 1.5	
Refrigerant	Refrigerant Name		R410A	R410A	R410A	R410A
	Precharged Amount in factory	kg	13.0	13.0	14.0	14.0
		lbs	28.7	28.7	30.9	30.9
	t-CO ₂ eq		27.1	27.1	29.2	29.2
	Control		Electronic Expansion Valve	Electronic Expansion Valve	Electronic Expansion Valve	Electronic Expansion Valve
Power Supply	Ø, V, Hz		3, 380 - 415, 50	3, 380 - 415, 50	3, 380 - 415, 50	3, 380 - 415, 50
			3, 380, 60	3, 380, 60	3, 380, 60	3, 380, 60
Number of Maxmum Connectable Indoor Units			26 (40)	29 (45)	32 (50)	35 (56)

- Note : 1. Due to our policy of innovation some specifications may be changed without notification.
 2. Wiring cable size must comply with the applicable local and national codes. And "Electric characteristics" chapter should be considered for electrical work and design. Especially the power cable and circuit breaker should be selected in accordance with that.
 3. Power factor could vary less than ±1% according to the operating conditions.
 4. Sound pressure level is measured on the rated condition in the anechoic rooms by ISO 3745 standard. Sound power level is measured on the rated condition in the reverberation rooms by ISO 3741 standard. Therefore, these values can be increased owing to ambient conditions during operation.
 5. Performances are based on the following conditions : Cooling : Indoor Ambient Temp. 27°CDB / 19°CWB, Outdoor Ambient Temp. 35°CDB / 24°CWB
 Heating : Indoor Ambient Temp. 20°CDB / 15°CWB, Outdoor Ambient Temp. 7°CDB / 6°CWB
 Interconnected Pipe Length is 7.5m and difference of Elevation (Outdoor - Indoor Unit) is Zero.
 6. The numbers in parentheses means maximum connectable indoor units in accordance with outdoor units combination. The recommended ratio is 130%.
 7. This product contains Fluorinated greenhouse gases.(R410A, GWP(Global warming potential) = 2087.5)
 ※ Eurovent test Condition

MULTI V 5

Non TROPICAL MODEL

STANDARD

ARUN240LTE5 / ARUN260LTE5 / ARUN221LTE5 / ARUN241LTE5

 LG participates in the ECP programme for EUROVENT VRF program. Check ongoing validity of certification : www.eurovent-certification.com



HP			24	26	22'	24'
Model Name	Combination Unit		ARUN240LTE5	ARUN260LTE5	ARUN221LTE5	ARUN241LTE5
	Independent Unit		ARUN240LTE5	ARUN260LTE5	ARUN120LTE5 ARUN100LTE5	ARUN120LTE5 ARUN120LTE5
Capacity	Cooling (Rated)	kW	67.2	72.8	61.6	67.2
		Btu/h	229,300	248,400	210,100	229,200
	Heating (Rated)	kW	74.3	74.3	69.3	75.6
		Btu/h	253,400	253,400	236,500	258,000
Input	Cooling (Rated)	kW	16.76	19.41	13.60	15.81
	Heating (Rated)	kW	18.85	19.49	13.80	16.12
Input	Cooling (Rated)	kW	14.9	20.49	16.8	23.79
	Heating (Rated)	kW	12.7	17.64	14.7	17.78
	Heating (Max.)	kW	15.3	20.87	17.8	21.29
EER (Rated)			4.01	3.75	4.53	4.25
COP (Rated)			3.94	3.81	5.01	4.69
EER			3.28	3.06	4.14	3.99
ESEER			6.98	5.58	6.72	5.38
ESEER (SLC)			7.95	6.83	7.74	6.47
Power Factor	Rated		0.93	0.93	0.93	0.93
Exterior	Color		Warm Gray / Dawn Gray	Warm Gray / Dawn Gray	Warm Gray / Dawn Gray	Warm Gray / Dawn Gray
	RAL code		NL503K / NA507K	NL503K / NA507K	NL503K / NA507K	NL503K / NA507K
Heat Exchanger			Wide Louver Plus	Wide Louver Plus	Wide Louver Plus	Wide Louver Plus
Compressor	Motor Output x Number	W x No.	5,300 x 2	5,300 x 2	5,300 x 2	5,300 x 2
	Type		Propeller fan	Propeller fan	Propeller fan	Propeller fan
Fan	Motor Output x Number	W	900 x 2	900 x 2	(1,200 x 1) + (1,200 x 1)	(1,200 x 1) + (1,200 x 1)
	Air Flow Rate (High)	m³/min	320 x 1	320 x 1	(240 x 1) + (240 x 1)	(240 x 1) + (240 x 1)
		ft³/min	11,301 x 1	11,301 x 1	(8,476 x 1) + (8,476 x 1)	(8,476 x 1) + (8,476 x 1)
	External Static Pressure (Max, Pa)		80	80	80	80
	Drive		DC INVERTER	DC INVERTER	DC INVERTER	DC INVERTER
Pipe Connctions	Discharge	Side / Top	TOP	TOP	TOP	TOP
	Liquid Pipe	mm (inch)	15.88 (5/8)	19.05 (3/4)	15.88 (5/8)	15.88 (5/8)
Dimensions (W x H x D)	Gas Pipe	mm (inch)	34.9 (1-3/8)	34.9 (1-3/8)	28.58 (1-1/8)	34.9 (1-3/8)
	mm		(1,240 x 1,690 x 760) x 1	(1,240 x 1,690 x 760) x 1	(930 x 1,690 x 760) x 2	(930 x 1,690 x 760) x 2
Net Weight		kg	283 x 1	283 x 1	199 x 2	199 x 2
		lbs	624 x 1	624 x 1	439 x 2	439 x 2
Sound Pressure Level	Cooling	dB(A)	65.0	65.0	61.5	62.0
	Heating	dB(A)	67.0	67.0	62.5	63.0
Sound Power Level	Cooling	dB(A)	88.0	88.0	81.5	82.0
	Heating	dB(A)	90.0	90.0	82.5	83.0
Communication Cable	No. x mm² (VCTF-SB)		2C x 1.0 - 1.5	2C x 1.0 - 1.5	2C x 1.0 - 1.5	2C x 1.0 - 1.5
Refrigerant	Refrigerant Name		R410A	R410A	R410A	R410A
	Precharged Amount in factory	kg	16.0	16.0	10.0 + 10.0	10.0 + 10.0
		lbs	35.3	35.3	22.0 + 22.0	22.0 + 22.0
	t-CO ₂ eq		33.4	33.4	41.8	41.8
Control			Electronic Expansion Valve	Electronic Expansion Valve	Electronic Expansion Valve	Electronic Expansion Valve
Power Supply	Ø, V, Hz		3, 380 - 415, 50	3, 380 - 415, 50	3, 380 - 415, 50	3, 380 - 415, 50
			3, 380, 60	3, 380, 60	3, 380, 60	3, 380, 60
Number of Maxmum Connectable Indoor Units			39 (61)	42 (64)	35 (44)	39 (48)

Note : 1. Due to our policy of innovation some specifications may be changed without notification.
 2. Wiring cable size must comply with the applicable local and national codes. And "Electric characteristics" chapter should be considered for electrical work and design. Especially the power cable and circuit breaker should be selected in accordance with that.
 3. Power factor could vary less than ±1% according to the operating conditions.
 4. Sound pressure level is measured on the rated condition in the anechoic rooms by ISO 3745 standard. Sound power level is measured on the rated condition in the reverberation rooms by ISO 3741 standard. Therefore, these values can be increased owing to ambient conditions during operation.
 5. Performances are based on the following conditions : Cooling : Indoor Ambient Temp. 27°CDB / 19°CWB, Outdoor Ambient Temp. 35°CDB / 24°CWB
 Heating : Indoor Ambient Temp. 20°CDB / 15°CWB, Outdoor Ambient Temp. 7°CDB / 6°CWB
 Interconnected Pipe Length is 7.5m and difference of Elevation (Outdoor - Indoor Unit) is Zero.
 6. The numbers in parentheses means maximum connectable indoor units in accordance with outdoor units combination. The recommended ratio is 130%.
 7. This product contains Fluorinated greenhouse gases.(R410A, GWP(Global warming potential) = 2087.5)
 ※ Eurovent test Condition

Non TROPICAL MODEL

STANDARD

ARUN261LTE5 / ARUN280LTE5 / ARUN300LTE5 / ARUN320LTE5



HP			26'	28	30	32
Model Name	Combination Unit		ARUN261LTE5	ARUN280LTE5	ARUN300LTE5	ARUN320LTE5
	Independent Unit		ARUN140LTE5 ARUN120LTE5	ARUN160LTE5 ARUN120LTE5	ARUN180LTE5 ARUN120LTE5	ARUN200LTE5 ARUN120LTE5
Capacity	Cooling (Rated)	kW	72.8	78.4	84.0	89.6
		Btu/h	248,400	267,500	286,600	305,700
	Heating (Rated)	kW	81.9	88.2	94.5	100.8
		Btu/h	279,500	301,000	322,500	344,000
Input	Cooling (Rated)	kW	17.02	18.70	18.86	20.21
	Heating (Rated)	kW	17.84	19.65	20.12	23.58
Input	Cooling (Rated)	kW	18.6	21.2	21.2	23.4
	Heating (Rated)	kW	16.4	18.8	18.6	20.9
	Heating (Max.)	kW	19.7	22.7	22.2	25.2
EER (Rated)			4.28	4.19	4.45	4.43
COP (Rated)			4.59	4.49	4.70	4.28
EER			3.91	3.69	3.95	3.82
ESEER			6.45	6.04	6.46	6.24
ESEER (SLC)			7.34	7.06	7.20	6.94
Power Factor	Rated		0.93	0.93	0.93	0.93
Exterior	Color		Warm Gray / Dawn Gray	Warm Gray / Dawn Gray	Warm Gray / Dawn Gray	Warm Gray / Dawn Gray
	RAL code		NL503K / NA507K	NL503K / NA507K	NL503K / NA507K	NL503K / NA507K
Heat Exchanger			Wide Louver Plus	Wide Louver Plus	Wide Louver Plus	Wide Louver Plus
Compressor	Motor Output x Number	W x No.	5,300 x 2	5,300 x 2	(5,300 x 2) + (4,200 x 1)	(5,300 x 2) + (4,200 x 1)
	Type		Propeller fan	Propeller fan	Propeller fan	Propeller fan
Fan	Motor Output x Number	W	(900 x 2) + (1,200 x 1)	(900 x 2) + (1,200 x 1)	(900 x 2) + (1,200 x 1)	(900 x 2) + (1,200 x 1)
	Air Flow Rate (High)	m³/min	(320 x 1) + (240 x 1)	(320 x 1) + (240 x 1)	(320 x 1) + (240 x 1)	(320 x 1) + (240 x 1)
		ft³/min	(11,301 x 1) + (8,476 x 1)	(11,301 x 1) + (8,476 x 1)	(11,301 x 1) + (8,476 x 1)	(11,301 x 1) + (8,476 x 1)
	External Static Pressure (Max, Pa)		80	80	80	80
	Drive		DC INVERTER	DC INVERTER	DC INVERTER	DC INVERTER
Pipe Connctions	Discharge	Side / Top	TOP	TOP	TOP	TOP
	Liquid Pipe	mm (inch)	19.05 (3/4)	19.05 (3/4)	19.05 (3/4)	19.05 (3/4)
Dimensions (W x H x D)	Gas Pipe	mm (inch)	34.9 (1-3/8)	34.9 (1-3/8)	34.9 (1-3/8)	34.9 (1-3/8)
	mm		(1,240 x 1,690 x 760) x 1 + (930 x 1,690 x 760) x 1	(1,240 x 1,690 x 760) x 1 + (930 x 1,690 x 760) x 1	(1,240 x 1,690 x 760) x 1 + (930 x 1,690 x 760) x 1	(1,240 x 1,690 x 760) x 1 + (930 x 1,690 x 760) x 1
Net Weight		kg	(221 x 1) + (199 x 1)	(221 x 1) + (199 x 1)	(261 x 1) + (199 x 1)	(281 x 1) + (199 x 1)
		lbs	(487 x 1) + (439 x 1)	(487 x 1) + (439 x 1)	(575 x 1) + (439 x 1)	(619 x 1) + (439 x 1)
Sound Pressure Level	Cooling	dB(A)	62.5	62.8	63.1	63.8
	Heating	dB(A)	63.5	63.8	64.1	65.8
Sound Power Level	Cooling	dB(A)	83.8	84.5	86.0	86.8
	Heating	dB(A)	85.5	86.2	87.0	87.8
Communication Cable	No. x mm² (VCTF-SB)		2C x 1.0 - 1.5	2C x 1.0 - 1.5	2C x 1.0 - 1.5	2C x 1.0 - 1.5
Refrigerant	Refrigerant Name		R410A	R410A	R410A	R410A
	Precharged Amount in factory	kg	13.0 + 10.0	13.0 + 10.0	13.0 + 10.0	14.0 + 10.0
		lbs	28.7 + 22.0	28.7 + 22.0	28.7 + 22.0	30.9 + 22.0
	t-CO ₂ eq		48.0	48.0	48.0	50.1
Control			Electronic Expansion Valve	Electronic Expansion Valve	Electronic Expansion Valve	Electronic Expansion Valve
Power Supply	Ø, V, Hz		3, 380 - 415, 50	3, 380 - 415, 50	3, 380 - 415, 50	3, 380 - 415, 50
			3, 380, 60	3, 380, 60	3, 380, 60	3, 380, 60
Number of Maxmum Connectable Indoor Units			42 (52)	45 (56)	49 (60)	52 (64)

Note : 1. Due to our policy of innovation some specifications may be changed without notification.
 2. Wiring cable size must comply with the applicable local and national codes. And "Electric characteristics" chapter should be considered for electrical work and design. Especially the power cable and circuit breaker should be selected in accordance with that.
 3. Power factor could vary less than ±1% according to the operating conditions.
 4. Sound pressure level is measured on the rated condition in the anechoic rooms by ISO 3745 standard. Sound power level is measured on the rated condition in the reverberation rooms by ISO 3741 standard. Therefore, these values can be increased owing to ambient conditions during operation.
 5. Performances are based on the following conditions : Cooling : Indoor Ambient Temp. 27°CDB / 19°CWB, Outdoor Ambient Temp. 35°CDB / 24°CWB
 Heating : Indoor Ambient Temp. 20°CDB / 15°CWB, Outdoor Ambient Temp. 7°CDB / 6°CWB
 Interconnected Pipe Length is 7.5m and difference of Elevation (Outdoor - Indoor Unit) is Zero.
 6. The numbers in parentheses means maximum connectable indoor units in accordance with outdoor units combination. The recommended ratio is 130%.
 7. This product contains Fluorinated greenhouse gases.(R410A, GWP(Global warming potential) = 2087.5)
 ※ Eurovent test Condition

MULTI V 5

Non TROPICAL MODEL

STANDARD

ARUN340LTE5 / ARUN360LTE5 / ARUN380LTE5 / ARUN400LTE5



HP			34	36	38	40
Model Name	Combination Unit		ARUN340LTE5	ARUN360LTE5	ARUN380LTE5	ARUN400LTE5
	Independent Unit		ARUN220LTE5 ARUN120LTE5	ARUN240LTE5 ARUN120LTE5	ARUN240LTE5 ARUN140LTE5	ARUN240LTE5 ARUN240LTE5
Capacity	Cooling (Rated)	kW	95.2	100.8	106.4	112.0
		Btu/h	324,800	343,900	363,100	382,200
	Heating (Rated)	kW	107.1	112.1	118.4	124.7
		Btu/h	365,500	382,400	403,900	425,400
Input	Cooling (Rated)	kW	22.75	24.66	25.87	27.55
	Heating (Rated)	kW	25.60	26.91	28.62	30.43
Input	Cooling (Rated)	kW	26.9	28.9	30.7	33.3
	Heating (Rated)	kW	23.1	25.0	26.7	29.1
	Heating (Max.)	kW	27.5	29.8	31.7	34.6
EER (Rated)			4.18	4.09	4.11	4.06
COP (Rated)			4.18	4.16	4.13	4.10
EER			3.54	3.49	3.47	3.36
ESEER			6.01	5.92	5.80	5.59
ESEER (SLC)			7.03	7.11	6.89	6.75
Power Factor	Rated	-	0.93	0.93	0.93	0.93
Exterior	Color		Warm Gray / Dawn Gray	Warm Gray / Dawn Gray	Warm Gray / Dawn Gray	Warm Gray / Dawn Gray
	RAL code		NL503K / NA507K	NL503K / NA507K	NL503K / NA507K	NL503K / NA507K
Heat Exchanger			Wide Louver Plus	Wide Louver Plus	Wide Louver Plus	Wide Louver Plus
Compressor	Motor Output x Number	W x No.	5,300 x 3	5,300 x 3	5,300 x 3	5,300 x 3
	Type		Propeller fan	Propeller fan	Propeller fan	Propeller fan
Fan	Motor Output x Number	W	(900 x 2) + (1,200 x 1)	(900 x 2) + (1,200 x 1)	900 x 4	900 x 4
	Air Flow Rate (High)	m³/min	(320 x 1) + (240 x 1)	(320 x 1) + (240 x 1)	320 x 2	320 x 2
		ft³/min	(11,301 x 1) + (8,476 x 1)	(11,301 x 1) + (8,476 x 1)	11,301 x 2	11,301 x 2
	External Static Pressure (Max, Pa)		80	80	80	80
	Drive		DC INVERTER	DC INVERTER	DC INVERTER	DC INVERTER
Pipe Connctions	Discharge	Side / Top	TOP	TOP	TOP	TOP
	Liquid Pipe	mm (inch)	19.05 (3/4)	19.05 (3/4)	19.05 (3/4)	19.05 (3/4)
Dimensions (W x H x D)	Gas Pipe	mm (inch)	34.9 (1-3/8)	41.3 (1-5/8)	41.3 (1-5/8)	41.3 (1-5/8)
		mm	(1,240 x 1,690 x 760) x 1 + (930 x 1,690 x 760) x 1	(1,240 x 1,690 x 760) x 1 + (930 x 1,690 x 760) x 1	(1,240 x 1,690 x 760) x 2	(1,240 x 1,690 x 760) x 2
Net Weight		kg	(281 x 1) + (199 x 1)	(283 x 1) + (199 x 1)	(283 x 1) + (221 x 1)	(283 x 1) + (221 x 1)
		lbs	(619 x 1) + (439 x 1)	(624 x 1) + (439 x 1)	(624 x 1) + (487 x 1)	(624 x 1) + (487 x 1)
Sound Pressure Level	Cooling	dB(A)	65.6	66.0	66.2	66.3
	Heating	dB(A)	66.6	67.8	68.0	68.1
Sound Power Level	Cooling	dB(A)	86.8	88.5	89.0	89.2
	Heating	dB(A)	88.6	90.4	91.0	91.2
Communication Cable		No. x mm² (VCTF-SB)	2C x 1.0 - 1.5	2C x 1.0 - 1.5	2C x 1.0 - 1.5	2C x 1.0 - 1.5
	Refrigerant Name		R410A	R410A	R410A	R410A
Refrigerant	Precharged Amount in factory	kg	14.0 + 10.0	16.0 + 10.0	16.0 + 13.0	16.0 + 13.0
		lbs	30.9 + 22.0	35.3 + 22.0	35.3 + 28.7	35.3 + 28.7
	t-CO ₂ eq		50.1	54.3	60.5	60.5
	Control		Electronic Expansion Valve	Electronic Expansion Valve	Electronic Expansion Valve	Electronic Expansion Valve
Power Supply	Ø, V, Hz		3, 380 - 415, 50	3, 380 - 415, 50	3, 380 - 415, 50	3, 380 - 415, 50
			3, 380, 60	3, 380, 60	3, 380, 60	3, 380, 60
Number of Maxmum Connectable Indoor Units			55 (64)	58 (64)	61 (64)	64

- Note : 1. Due to our policy of innovation some specifications may be changed without notification.
- Wiring cable size must comply with the applicable local and national codes. And "Electric characteristics" chapter should be considered for electrical work and design. Especially the power cable and circuit breaker should be selected in accordance with that.
 - Power factor could vary less than ±1% according to the operating conditions.
 - Sound pressure level is measured on the rated condition in the anechoic rooms by ISO 3745 standard. Sound power level is measured on the rated condition in the reverberation rooms by ISO 3741 standard. Therefore, these values can be increased owing to ambient conditions during operation.
 - Performances are based on the following conditions : Cooling : Indoor Ambient Temp. 27°CDB / 19°CWB, Outdoor Ambient Temp. 35°CDB / 24°CWB
Heating : Indoor Ambient Temp. 20°CDB / 15°CWB, Outdoor Ambient Temp. 7°CDB / 6°CWB
Interconnected Pipe Length is 7.5m and difference of Elevation (Outdoor - Indoor Unit) is Zero.
 - The numbers in parentheses means maximum connectable indoor units in accordance with outdoor units combination. The recommended ratio is 130%.
 - This product contains Fluorinated greenhouse gases.(R410A, GWP(Global warming potential) = 2087.5)
- ※ Eurovent test Condition

Non TROPICAL MODEL

STANDARD

ARUN420LTE5 / ARUN440LTE5 / ARUN460LTE5 / ARUN480LTE5



HP			42	44	46	48
Model Name	Combination Unit		ARUN420LTE5	ARUN440LTE5	ARUN460LTE5	ARUN480LTE5
	Independent Unit		ARUN240LTE5 ARUN180LTE5	ARUN240LTE5 ARUN200LTE5	ARUN240LTE5 ARUN220LTE5	ARUN240LTE5 ARUN240LTE5
Capacity	Cooling (Rated)	kW	117.6	123.2	128.8	134.4
		Btu/h	401,300	420,400	439,500	458,600
	Heating (Rated)	kW	131.0	137.3	143.6	148.5
		Btu/h	446,900	468,400	489,900	506,800
Input	Cooling (Rated)	kW	27.71	29.07	31.60	33.52
	Heating (Rated)	kW	30.91	34.36	36.39	37.69
Input	Cooling (Rated)	kW	33.3	35.5	38.9	41.0
	Heating (Rated)	kW	28.9	31.2	33.4	35.3
	Heating (Max.)	kW	34.1	37.2	39.5	41.7
EER (Rated)			4.24	4.24	4.08	4.01
COP (Rated)			4.24	3.99	3.94	3.94
EER			3.53	3.47	3.31	3.28
ESEER			5.87	5.75	5.63	5.58
ESEER (SLC)			6.84	6.68	6.77	6.83
Power Factor	Rated	-	0.93	0.93	0.93	0.93
Exterior	Color		Warm Gray / Dawn Gray	Warm Gray / Dawn Gray	Warm Gray / Dawn Gray	Warm Gray / Dawn Gray
	RAL code		NL503K / NA507K	NL503K / NA507K	NL503K / NA507K	NL503K / NA507K
Heat Exchanger			Wide Louver Plus	Wide Louver Plus	Wide Louver Plus	Wide Louver Plus
Compressor	Motor Output x Number	W x No.	(5,300 x 3) + (4,200 x 1)	5,300 x 4	5,300 x 4	5,300 x 4
	Type		Propeller fan	Propeller fan	Propeller fan	Propeller fan
Fan	Motor Output x Number	W	900 x 4	900 x 4	900 x 4	900 x 4
	Air Flow Rate (High)	m³/min	320 x 2	320 x 2	320 x 2	320 x 2
		ft³/min	11,301 x 2	11,301 x 2	11,301 x 2	11,301 x 2
	External Static Pressure (Max, Pa)		80	80	80	80
	Drive		DC INVERTER	DC INVERTER	DC INVERTER	DC INVERTER
Pipe Connctions	Discharge	Side / Top	TOP	TOP	TOP	TOP
	Liquid Pipe	mm (inch)	19.05 (3/4)	19.05 (3/4)	19.05 (3/4)	19.05 (3/4)
Dimensions (W x H x D)	Gas Pipe	mm (inch)	41.3 (1-5/8)	41.3 (1-5/8)	41.3 (1-5/8)	41.3 (1-5/8)
		mm	(1,240 x 1,690 x 760) x 2	(1,240 x 1,690 x 760) x 2	(1,240 x 1,690 x 760) x 2	(1,240 x 1,690 x 760) x 2
Net Weight		kg	(283 x 1) + (261 x 1)	(283 x 1) + (281 x 1)	(283 x 1) + (281 x 1)	283 x 2
		lbs	(624 x 1) + (575 x 1)	(624 x 1) + (619 x 1)	(624 x 1) + (619 x 1)	624 x 2
Sound Pressure Level	Cooling	dB(A)	66.5	66.8	67.8	68.0
	Heating	dB(A)	68.2	68.9	69.3	70.0
Sound Power Level	Cooling	dB(A)	89.8	90.1	90.1	91.0
	Heating	dB(A)	91.5	91.8	92.1	93.0
Communication Cable		No. x mm² (VCTF-SB)	2C x 1.0 - 1.5	2C x 1.0 - 1.5	2C x 1.0 - 1.5	2C x 1.0 - 1.5
	Refrigerant Name		R410A	R410A	R410A	R410A
Refrigerant	Precharged Amount in factory	kg	16.0 + 13.0	16.0 + 14.0	16.0 + 14.0	16.0 + 16.0
		lbs	35.3 + 28.7	35.3 + 30.9	35.3 + 30.9	35.3 + 35.3
	t-CO ₂ eq		60.5	62.6	62.6	66.8
	Control		Electronic Expansion Valve	Electronic Expansion Valve	Electronic Expansion Valve	Electronic Expansion Valve
Power Supply	Ø, V, Hz		3, 380 - 415, 50	3, 380 - 415, 50	3, 380 - 415, 50	3, 380 - 415, 50
			3, 380, 60	3, 380, 60	3, 380, 60	3, 380, 60
Number of Maxmum Connectable Indoor Units			64	64	64	64

- Note : 1. Due to our policy of innovation some specifications may be changed without notification.
- Wiring cable size must comply with the applicable local and national codes. And "Electric characteristics" chapter should be considered for electrical work and design. Especially the power cable and circuit breaker should be selected in accordance with that.
 - Power factor could vary less than ±1% according to the operating conditions.
 - Sound pressure level is measured on the rated condition in the anechoic rooms by ISO 3745 standard. Sound power level is measured on the rated condition in the reverberation rooms by ISO 3741 standard. Therefore, these values can be increased owing to ambient conditions during operation.
 - Performances are based on the following conditions : Cooling : Indoor Ambient Temp. 27°CDB / 19°CWB, Outdoor Ambient Temp. 35°CDB / 24°CWB
Heating : Indoor Ambient Temp. 20°CDB / 15°CWB, Outdoor Ambient Temp. 7°CDB / 6°CWB
Interconnected Pipe Length is 7.5m and difference of Elevation (Outdoor - Indoor Unit) is Zero.
 - The numbers in parentheses means maximum connectable indoor units in accordance with outdoor units combination. The recommended ratio is 130%.
 - This product contains Fluorinated greenhouse gases.(R410A, GWP(Global warming potential) = 2087.5)
- ※ Eurovent test Condition

MULTI V 5

Non TROPICAL MODEL

STANDARD

ARUN500LTE5 / ARUN520LTE5 / ARUN540LTE5 / ARUN560LTE5



HP			50	52	54	56
Model Name	Combination Unit		ARUN500LTE5	ARUN520LTE5	ARUN540LTE5	ARUN560LTE5
	Independent Unit		ARUN240LTE5 ARUN140LTE5 ARUN120LTE5	ARUN240LTE5 ARUN160LTE5 ARUN120LTE5	ARUN240LTE5 ARUN180LTE5 ARUN120LTE5	ARUN240LTE5 ARUN200LTE5 ARUN120LTE5
Capacity	Cooling (Rated)	kW	140.0	145.6	151.2	156.8
		Btu/h	477,700	496,800	515,900	535,000
	Heating (Rated)	kW	156.2	162.5	168.8	175.1
		Btu/h	532,900	554,400	575,900	597,400
Input	Cooling (Rated)	kW	33.78	35.46	35.62	36.97
	Heating (Rated)	kW	36.68	38.49	38.97	42.42
Input	Cooling (Rated)	kW	39.1	41.7	41.7	43.9
	Heating (Rated)	kW	34.0	36.4	36.3	38.6
Input	Heating (Max.)	kW	40.6	43.5	43.0	46.1
	EER (Rated)		4.14	4.11	4.24	4.24
COP (Rated)			4.26	4.22	4.33	4.13
EER			3.58	3.49	3.62	3.57
ESEER			6.00	5.82	6.04	5.94
ESEER (SLC)			7.08	6.95	7.02	6.89
Power Factor	Rated	-	0.93	0.93	0.93	0.93
Exterior	Color		Warm Gray / Dawn Gray	Warm Gray / Dawn Gray	Warm Gray / Dawn Gray	Warm Gray / Dawn Gray
	RAL code		NL503K / NA507K	NL503K / NA507K	NL503K / NA507K	NL503K / NA507K
Heat Exchanger			Wide Louver Plus	Wide Louver Plus	Wide Louver Plus	Wide Louver Plus
Compressor	Motor Output x Number	W x No.	5,300 x 4	5,300 x 4	(5,300 x 4) + (4,200 x 1)	5,300 x 5
	Type		Propeller fan	Propeller fan	Propeller fan	Propeller fan
Fan	Motor Output x Number	W	(900 x 4) + (1,200 x 1)	(900 x 4) + (1,200 x 1)	(900 x 4) + (1,200 x 1)	(900 x 4) + (1,200 x 1)
	Air Flow Rate (High)	m ³ /min ft ³ /min	(320 x 2) + (240 x 1) (11,301 x 2) + (8,476 x 1)	(320 x 2) + (240 x 1) (11,301 x 2) + (8,476 x 1)	(320 x 2) + (240 x 1) (11,301 x 2) + (8,476 x 1)	(320 x 2) + (240 x 1) (11,301 x 2) + (8,476 x 1)
	External Static Pressure (Max, Pa)		80	80	80	80
	Drive		DC INVERTER	DC INVERTER	DC INVERTER	DC INVERTER
	Discharge	Side / Top	TOP	TOP	TOP	TOP
Pipe Connctions	Liquid Pipe	mm (inch)	19.05 (3/4)	19.05 (3/4)	19.05 (3/4)	19.05 (3/4)
	Gas Pipe	mm (inch)	41.3 (1-5/8)	41.3 (1-5/8)	41.3 (1-5/8)	41.3 (1-5/8)
Dimensions (W x H x D)		mm	(1,240 x 1,690 x 760) x 2 + (930 x 1,690 x 760) x 1	(1,240 x 1,690 x 760) x 2 + (930 x 1,690 x 760) x 1	(1,240 x 1,690 x 760) x 2 + (930 x 1,690 x 760) x 1	(1,240 x 1,690 x 760) x 2 + (930 x 1,690 x 760) x 1
Net Weight		kg	(283 x 1) + (221 x 1) + (199 x 1)	(283 x 1) + (221 x 1) + (199 x 1)	(283 x 1) + (261 x 1) + (199 x 1)	(283 x 1) + (281 x 1) + (199 x 1)
		lbs	(624 x 1) + (487 x 1) + (439 x 1)	(624 x 1) + (487 x 1) + (439 x 1)	(624 x 1) + (575 x 1) + (439 x 1)	(624 x 1) + (619 x 1) + (439 x 1)
Sound Pressure Level	Cooling	dB(A)	67.0	67.1	67.2	67.4
	Heating	dB(A)	68.6	68.7	68.8	69.5
Sound Power Level	Cooling	dB(A)	89.4	89.6	90.1	90.4
	Heating	dB(A)	91.3	91.5	91.8	92.0
Communication Cable		No. x mm ² (VCTF-SB)	2C x 1.0 - 1.5	2C x 1.0 - 1.5	2C x 1.0 - 1.5	2C x 1.0 - 1.5
Refrigerant	Refrigerant Name		R410A	R410A	R410A	R410A
	Precharged Amount in factory	kg	16.0 + 13.0 + 10.0	16.0 + 13.0 + 10.0	16.0 + 13.0 + 10.0	16.0 + 14.0 + 10.0
		lbs	35.3 + 28.7 + 22.0	35.3 + 28.7 + 22.0	35.3 + 28.7 + 22.0	35.3 + 30.9 + 22.0
	t-CO ₂ eq		81.4	81.4	81.4	83.5
	Control		Electronic Expansion Valve	Electronic Expansion Valve	Electronic Expansion Valve	Electronic Expansion Valve
Power Supply		∅, V, Hz	3, 380 - 415, 50	3, 380 - 415, 50	3, 380 - 415, 50	3, 380 - 415, 50
			3, 380, 60	3, 380, 60	3, 380, 60	3, 380, 60
Number of Maxmum Connectable Indoor Units			64	64	64	64

Note : 1. Due to our policy of innovation some specifications may be changed without notification.
 2. Wiring cable size must comply with the applicable local and national codes. And "Electric characteristics" chapter should be considered for electrical work and design. Especially the power cable and circuit breaker should be selected in accordance with that.
 3. Power factor could vary less than ±1% according to the operating conditions.
 4. Sound pressure level is measured on the rated condition in the anechoic rooms by ISO 3745 standard. Sound power level is measured on the rated condition in the reverberation rooms by ISO 3741 standard. Therefore, these values can be increased owing to ambient conditions during operation.
 5. Performances are based on the following conditions : Cooling : Indoor Ambient Temp. 27°CDB / 19°CWB, Outdoor Ambient Temp. 35°CDB / 24°CWB
 Heating : Indoor Ambient Temp. 20°CDB / 15°CWB, Outdoor Ambient Temp. 7°CDB / 6°CWB
 Interconnected Pipe Length is 7.5m and difference of Elevation (Outdoor - Indoor Unit) is Zero.
 6. The numbers in parentheses means maximum connectable indoor units in accordance with outdoor units combination. The recommended ratio is 130%.
 7. This product contains Fluorinated greenhouse gases.(R410A, GWP(Global warming potential) = 2087.5)
 ※ Eurovent test Condition

Non TROPICAL MODEL

STANDARD

ARUN580LTE5 / ARUN600LTE5 / ARUN620LTE5 / ARUN640LTE5



HP			58	60	62	64
Model Name	Combination Unit		ARUN580LTE5	ARUN600LTE5	ARUN620LTE5	ARUN640LTE5
	Independent Unit		ARUN240LTE5 ARUN220LTE5 ARUN120LTE5	ARUN240LTE5 ARUN200LTE5 ARUN120LTE5	ARUN240LTE5 ARUN240LTE5 ARUN140LTE5	ARUN240LTE5 ARUN240LTE5 ARUN160LTE5
Capacity	Cooling (Rated)	kW	162.4	168.0	173.6	179.2
		Btu/h	554,100	573,200	592,400	611,500
	Heating (Rated)	kW	181.4	186.3	192.6	198.9
		Btu/h	618,900	635,800	657,300	678,800
Input	Cooling (Rated)	kW	39.51	41.42	42.63	44.31
	Heating (Rated)	kW	44.45	45.75	47.47	49.28
Input	Cooling (Rated)	kW	47.4	49.4	51.2	53.8
	Heating (Rated)	kW	40.7	42.6	44.3	46.7
Input	Heating (Max.)	kW	48.4	50.6	52.5	55.5
	EER (Rated)		4.11	4.06	4.07	4.04
COP (Rated)			4.08	4.07	4.06	4.04
EER			3.43	3.40	3.39	3.33
ESEER			5.83	5.78	5.71	5.59
ESEER (SLC)			6.95	7.00	6.87	6.78
Power Factor	Rated	-	0.93	0.93	0.93	0.93
Exterior	Color		Warm Gray / Dawn Gray	Warm Gray / Dawn Gray	Warm Gray / Dawn Gray	Warm Gray / Dawn Gray
	RAL code		NL503K / NA507K	NL503K / NA507K	NL503K / NA507K	NL503K / NA507K
Heat Exchanger			Wide Louver Plus	Wide Louver Plus	Wide Louver Plus	Wide Louver Plus
Compressor	Motor Output x Number	W x No.	5,300 x 5	5,300 x 5	5,300 x 5	5,300 x 5
	Type		Propeller fan	Propeller fan	Propeller fan	Propeller fan
Fan	Motor Output x Number	W	(900 x 4) + (1,200 x 1)	(900 x 4) + (1,200 x 1)	900 x 6	900 x 6
	Air Flow Rate (High)	m ³ /min ft ³ /min	(320 x 2) + (240 x 1) (11,301 x 2) + (8,476 x 1)	(320 x 2) + (240 x 1) (11,301 x 2) + (8,476 x 1)	320 x 3 11,301 x 3	320 x 3 11,301 x 3
	External Static Pressure (Max, Pa)		80	80	80	80
	Drive		DC INVERTER	DC INVERTER	DC INVERTER	DC INVERTER
	Discharge	Side / Top	TOP	TOP	TOP	TOP
Pipe Connctions	Liquid Pipe	mm (inch)	19.05 (3/4)	19.05 (3/4)	22.2 (7/8)	22.2 (7/8)
	Gas Pipe	mm (inch)	41.3 (1-5/8)	41.3 (1-5/8)	44.5 (1-3/4)	44.5 (1-3/4)
Dimensions (W x H x D)		mm	(1,240 x 1,690 x 760) x 2 + (930 x 1,690 x 760) x 1	(1,240 x 1,690 x 760) x 2 + (930 x 1,690 x 760) x 1	(1,240 x 1,690 x 760) x 3	(1,240 x 1,690 x 760) x 3
Net Weight		kg	(283 x 1) + (281 x 1) + (199 x 1)	(283 x 2) + (199 x 1)	(283 x 2) + (221 x 1)	(283 x 2) + (221 x 1)
		lbs	(624 x 1) + (619 x 1) + (439 x 1)	(624 x 2) + (439 x 1)	(624 x 2) + (487 x 1)	(624 x 2) + (487 x 1)
Sound Pressure Level	Cooling	dB(A)	68.3	68.5	68.6	68.7
	Heating	dB(A)	69.8	70.4	70.5	70.6
Sound Power Level	Cooling	dB(A)	90.4	91.3	91.5	91.6
	Heating	dB(A)	92.4	93.2	93.5	93.6
Communication Cable		No. x mm ² (VCTF-SB)	2C x 1.0 - 1.5	2C x 1.0 - 1.5	2C x 1.0 - 1.5	2C x 1.0 - 1.5
Refrigerant	Refrigerant Name		R410A	R410A	R410A	R410A
	Precharged Amount in factory	kg	16.0 + 14.0 + 10.0	16.0 + 16.0 + 10.0	16.0 + 16.0 + 13.0	16.0 + 16.0 + 13.0
		lbs	35.3 + 30.9 + 22.0	35.3 + 35.3 + 22.0	35.3 + 35.3 + 28.7	35.3 + 35.3 + 28.7
	t-CO ₂ eq		83.5	87.7	93.9	93.9
	Control		Electronic Expansion Valve	Electronic Expansion Valve	Electronic Expansion Valve	Electronic Expansion Valve
Power Supply		∅, V, Hz	3, 380 - 415, 50	3, 380 - 415, 50	3, 380 - 415, 50	3, 380 - 415, 50
			3, 380, 60	3, 380, 60	3, 380, 60	3, 380, 60
Number of Maxmum Connectable Indoor Units			64	64	64	64

Note : 1. Due to our policy of innovation some specifications may be changed without notification.
 2. Wiring cable size must comply with the applicable local and national codes. And "Electric characteristics" chapter should be considered for electrical work and design. Especially the power cable and circuit breaker should be selected in accordance with that.
 3. Power factor could vary less than ±1% according to the operating conditions.
 4. Sound pressure level is measured on the rated condition in the anechoic rooms by ISO 3745 standard. Sound power level is measured on the rated condition in the reverberation rooms by ISO 3741 standard. Therefore, these values can be increased owing to ambient conditions during operation.
 5. Performances are based on the following conditions : Cooling : Indoor Ambient Temp. 27°CDB / 19°CWB, Outdoor Ambient Temp. 35°CDB / 24°CWB
 Heating : Indoor Ambient Temp. 20°CDB / 15°CWB, Outdoor Ambient Temp. 7°CDB / 6°CWB
 Interconnected Pipe Length is 7.5m and difference of Elevation (Outdoor - Indoor Unit) is Zero.
 6. The numbers in parentheses means maximum connectable indoor units in accordance with outdoor units combination. The recommended ratio is 130%.
 7. This product contains Fluorinated greenhouse gases.(R410A, GWP(Global warming potential) = 2087.5)
 ※ Eurovent test Condition

MULTI V 5

Non TROPICAL MODEL

STANDARD

ARUN660LTE5 / ARUN680LTE5 / ARUN700LTE5 / ARUN720LTE5



HP			66	68	70	72
Model Name	Combination Unit		ARUN660LTE5	ARUN680LTE5	ARUN700LTE5	ARUN720LTE5
	Independent Unit		ARUN240LTE5 ARUN240LTE5 ARUN180LTE5	ARUN240LTE5 ARUN240LTE5 ARUN200LTE5	ARUN240LTE5 ARUN240LTE5 ARUN220LTE5	ARUN240LTE5 ARUN240LTE5 ARUN240LTE5
Capacity	Cooling (Rated)	kW	184.8	190.4	196.0	201.6
		Btu/h	630,600	649,700	668,800	687,900
	Heating (Rated)	kW	205.2	211.5	217.8	222.8
		Btu/h	700,300	721,800	743,300	760,200
Input	Cooling (Rated)	kW	44.47	45.82	48.36	50.27
	Heating (Rated)	kW	49.76	53.21	55.24	56.54
Input	Cooling (Rated)	kW	53.8	56.0	59.4	61.5
	Heating (Rated)	kW	46.5	48.8	51.0	52.9
	Heating (Max.)	kW	55.0	58.1	60.3	62.6
EER (Rated)			4.16	4.16	4.05	4.01
COP (Rated)			4.12	3.97	3.94	3.94
EER			3.43	3.40	3.30	3.28
ESEER			5.76	5.69	5.61	5.58
ESEER (SLC)			6.84	6.73	6.79	6.83
Power Factor	Rated	-	0.93	0.93	0.93	0.93
Exterior	Color		Warm Gray / Dawn Gray	Warm Gray / Dawn Gray	Warm Gray / Dawn Gray	Warm Gray / Dawn Gray
	RAL code		NL503K / NA507K	NL503K / NA507K	NL503K / NA507K	NL503K / NA507K
Heat Exchanger			Wide Louver Plus	Wide Louver Plus	Wide Louver Plus	Wide Louver Plus
Compressor	Motor Output x Number	W x No.	(5,300 x 5) + (4,200 x 1)	5,300 x 6	5,300 x 6	5,300 x 6
	Type		Propeller fan	Propeller fan	Propeller fan	Propeller fan
Fan	Motor Output x Number	W	900 x 6	900 x 6	900 x 6	900 x 6
	Air Flow Rate (High)	m³/min	320 x 3	320 x 3	320 x 3	320 x 3
		ft³/min	11,301 x 3	11,301 x 3	11,301 x 3	11,301 x 3
	External Static Pressure (Max, Pa)		80	80	80	80
Drive		DC INVERTER	DC INVERTER	DC INVERTER	DC INVERTER	
Pipe Connctions	Liquid Pipe	mm (inch)	22.2 (7/8)	22.2 (7/8)	22.2 (7/8)	22.2 (7/8)
	Gas Pipe	mm (inch)	53.98 (2-1/8)	53.98 (2-1/8)	53.98 (2-1/8)	53.98 (2-1/8)
Dimensions (W x H x D)	mm	(1,240 x 1,690 x 760) x 3	(1,240 x 1,690 x 760) x 3	(1,240 x 1,690 x 760) x 3	(1,240 x 1,690 x 760) x 3	
Net Weight	kg	(290 x 2) + (270 x 1)	(290 x 2) + (288 x 1)	(290 x 2) + (288 x 1)	290 x 3	
	lbs	(639 x 2) + (595 x 1)	(639 x 2) + (635 x 1)	(639 x 2) + (635 x 1)	639 x 3	
Sound Pressure Level	Cooling	dB(A)	68.8	69.0	69.6	69.8
	Heating	dB(A)	70.6	71.1	71.3	71.8
Sound Power Level	Cooling	dB(A)	92.0	92.2	92.2	92.8
	Heating	dB(A)	93.8	94.0	94.2	94.8
Communication Cable	No. x mm² (VCTF-SB)		2C x 1.0 - 1.5	2C x 1.0 - 1.5	2C x 1.0 - 1.5	2C x 1.0 - 1.5
Refrigerant	Refrigerant Name		R410A	R410A	R410A	R410A
	Precharged Amount in factory	kg	16.0 + 16.0 + 13.0	16.0 + 16.0 + 14.0	16.0 + 16.0 + 14.0	16.0 + 16.0 + 16.0
		lbs	35.3 + 35.3 + 28.7	35.3 + 35.3 + 30.9	35.3 + 35.3 + 30.9	35.3 + 35.3 + 35.3
	t-CO ₂ eq		93.9	96.0	96.0	100.2
Control		Electronic Expansion Valve	Electronic Expansion Valve	Electronic Expansion Valve	Electronic Expansion Valve	
Power Supply	Ø, V, Hz		3, 380 - 415, 50	3, 380 - 415, 50	3, 380 - 415, 50	3, 380 - 415, 50
			3, 380, 60	3, 380, 60	3, 380, 60	3, 380, 60
Number of Maxmum Connectable Indoor Units			64	64	64	64

- Note : 1. Due to our policy of innovation some specifications may be changed without notification.
 2. Wiring cable size must comply with the applicable local and national codes. And "Electric characteristics" chapter should be considered for electrical work and design. Especially the power cable and circuit breaker should be selected in accordance with that.
 3. Power factor could vary less than ±1% according to the operating conditions.
 4. Sound pressure level is measured on the rated condition in the anechoic rooms by ISO 3745 standard. Sound power level is measured on the rated condition in the reverberation rooms by ISO 3741 standard. Therefore, these values can be increased owing to ambient conditions during operation.
 5. Performances are based on the following conditions : Cooling : Indoor Ambient Temp. 27°CDB / 19°CWB, Outdoor Ambient Temp. 35°CDB / 24°CWB
 Heating : Indoor Ambient Temp. 20°CDB / 15°CWB, Outdoor Ambient Temp. 7°CDB / 6°CWB
 Interconnected Pipe Length is 7.5m and difference of Elevation (Outdoor - Indoor Unit) is Zero.
 6. The numbers in parentheses means maximum connectable indoor units in accordance with outdoor units combination. The recommended ratio is 130%.
 7. This product contains Fluorinated greenhouse gases.(R410A, GWP(Global warming potential) = 2087.5)

※ Eurovent test Condition

Non TROPICAL MODEL

STANDARD

ARUN740LTE5 / ARUN760LTE5 / ARUN780LTE5 / ARUN800LTE5



HP			74	76	78	80
Model Name	Combination Unit		ARUN740LTE5	ARUN760LTE5	ARUN780LTE5	ARUN800LTE5
	Independent Unit		ARUN240LTE5 ARUN240LTE5 ARUN140LTE5 ARUN120LTE5	ARUN240LTE5 ARUN240LTE5 ARUN160LTE5 ARUN120LTE5	ARUN240LTE5 ARUN240LTE5 ARUN180LTE5 ARUN120LTE5	ARUN240LTE5 ARUN240LTE5 ARUN200LTE5 ARUN120LTE5
Capacity	Cooling (Rated)	kW	207.2	212.8	218.4	224.0
		Btu/h	707,000	726,100	745,200	764,300
	Heating (Rated)	kW	230.4	236.7	243.0	249.3
		Btu/h	786,300	807,800	829,300	850,800
Input	Cooling (Rated)	kW	50.54	52.22	52.38	53.73
	Heating (Rated)	kW	55.53	57.34	57.82	61.27
Input	Cooling (Rated)	kW	59.6	62.2	62.2	64.4
	Heating (Rated)	kW	51.7	54.1	53.9	56.2
	Heating (Max.)	kW	61.4	64.4	63.9	66.9
EER (Rated)			4.10	4.08	4.17	4.17
COP (Rated)			4.15	4.13	4.20	4.07
EER			3.48	3.42	3.51	3.48
ESEER			5.86	5.74	5.89	5.83
ESEER (SLC)			7.00	6.91	6.96	6.87
Power Factor	Rated	-	0.93	0.93	0.93	0.93
Exterior	Color		Warm Gray / Dawn Gray	Warm Gray / Dawn Gray	Warm Gray / Dawn Gray	Warm Gray / Dawn Gray
	RAL code		NL503K / NA507K	NL503K / NA507K	NL503K / NA507K	NL503K / NA507K
Heat Exchanger			Wide Louver Plus	Wide Louver Plus	Wide Louver Plus	Wide Louver Plus
Compressor	Motor Output x Number	W x No.	5,300 x 6	5,300 x 6	(5,300 x 6) + (4,200 x 1)	5,300 x 7
	Type		Propeller fan	Propeller fan	Propeller fan	Propeller fan
Fan	Motor Output x Number	W	(900 x 6) + (1,200 x 1)	(900 x 6) + (1,200 x 1)	(900 x 6) + (1,200 x 1)	(900 x 6) + (1,200 x 1)
	Air Flow Rate (High)	m³/min	(320 x 3) + (240 x 1)	(320 x 3) + (240 x 1)	(320 x 3) + (240 x 1)	(320 x 3) + (240 x 1)
		ft³/min	(11,301 x 3) + (8,476 x 1)	(11,301 x 3) + (8,476 x 1)	(11,301 x 3) + (8,476 x 1)	(11,301 x 3) + (8,476 x 1)
	External Static Pressure (Max, Pa)		80	80	80	80
Drive		DC INVERTER	DC INVERTER	DC INVERTER	DC INVERTER	
Pipe Connctions	Liquid Pipe	mm (inch)	22.2 (7/8)	22.2 (7/8)	22.2 (7/8)	22.2 (7/8)
	Gas Pipe	mm (inch)	53.98 (2-1/8)	53.98 (2-1/8)	53.98 (2-1/8)	53.98 (2-1/8)
Dimensions (W x H x D)	mm	(1,240 x 1,690 x 760) x 3 + (930 x 1,690 x 760) x 1	(1,240 x 1,690 x 760) x 3 + (930 x 1,690 x 760) x 1	(1,240 x 1,690 x 760) x 3 + (930 x 1,690 x 760) x 1	(1,240 x 1,690 x 760) x 3 + (930 x 1,690 x 760) x 1	
Net Weight	kg	(290 x 2) + (230 x 1) + (203 x 1)	(290 x 2) + (230 x 1) + (203 x 1)	(290 x 2) + (270 x 1) + (203 x 1)	(290 x 2) + (288 x 1) + (203 x 1)	
	lbs	(639 x 2) + (507 x 1) + (448 x 1)	(639 x 2) + (507 x 1) + (448 x 1)	(639 x 2) + (595 x 1) + (448 x 1)	(639 x 2) + (635 x 1) + (448 x 1)	
Sound Pressure Level	Cooling	dB(A)	69.1	69.2	69.2	69.4
	Heating	dB(A)	70.9	70.9	71.0	71.4
Sound Power Level	Cooling	dB(A)	91.8	91.9	92.2	92.4
	Heating	dB(A)	93.7	93.8	94.0	94.2
Communication Cable	No. x mm² (VCTF-SB)		2C x 1.0 - 1.5	2C x 1.0 - 1.5	2C x 1.0 - 1.5	2C x 1.0 - 1.5
Refrigerant	Refrigerant Name		R410A	R410A	R410A	R410A
	Precharged Amount in factory	kg	16.0 + 16.0 + 13.0 + 10.0	16.0 + 16.0 + 13.0 + 10.0	16.0 + 16.0 + 13.0 + 10.0	16.0 + 16.0 + 14.0 + 10.0
		lbs	35.3 + 35.3 + 28.7 + 22.0	35.3 + 35.3 + 28.7 + 22.0	35.3 + 35.3 + 28.7 + 22.0	35.3 + 35.3 + 30.9 + 22.0
	t-CO ₂ eq		114.8	114.8	114.8	116.9
Control		Electronic Expansion Valve	Electronic Expansion Valve	Electronic Expansion Valve	Electronic Expansion Valve	
Power Supply	Ø, V, Hz		3, 380 - 415, 50	3, 380 - 415, 50	3, 380 - 415, 50	3, 380 - 415, 50
			3, 380, 60	3, 380, 60	3, 380, 60	3, 380, 60
Number of Maxmum Connectable Indoor Units			64	64	64	64

- Note : 1. Due to our policy of innovation some specifications may be changed without notification.
 2. Wiring cable size must comply with the applicable local and national codes. And "Electric characteristics" chapter should be considered for electrical work and design. Especially the power cable and circuit breaker should be selected in accordance with that.
 3. Power factor could vary less than ±1% according to the operating conditions.
 4. Sound pressure level is measured on the rated condition in the anechoic rooms by ISO 3745 standard. Sound power level is measured on the rated condition in the reverberation rooms by ISO 3741 standard. Therefore, these values can be increased owing to ambient conditions during operation.
 5. Performances are based on the following conditions : Cooling : Indoor Ambient Temp. 27°CDB / 19°CWB, Outdoor Ambient Temp. 35°CDB / 24°CWB
 Heating : Indoor Ambient Temp. 20°CDB / 15°CWB, Outdoor Ambient Temp. 7°CDB / 6°CWB
 Interconnected Pipe Length is 7.5m and difference of Elevation (Outdoor - Indoor Unit) is Zero.
 6. The numbers in parentheses means maximum connectable indoor units in accordance with outdoor units combination. The recommended ratio is 130%.
 7. This product contains Fluorinated greenhouse gases.(R410A, GWP(Global warming potential) = 2087.5)

※ Eurovent test Condition

MULTI V 5

Non TROPICAL MODEL

STANDARD

ARUN820LTE5 / ARUN840LTE5
ARUN860LTE5 / ARUN880LTE5



HP			82	84	86	88
Model Name	Combination Unit		ARUN820LTE5	ARUN840LTE5	ARUN860LTE5	ARUN880LTE5
	Independent Unit		ARUN240LTE5 ARUN240LTE5 ARUN220LTE5 ARUN120LTE5	ARUN240LTE5 ARUN240LTE5 ARUN240LTE5 ARUN120LTE5	ARUN240LTE5 ARUN240LTE5 ARUN240LTE5 ARUN140LTE5	ARUN240LTE5 ARUN240LTE5 ARUN240LTE5 ARUN160LTE5
Capacity	Cooling (Rated)	kW	229.6	235.2	240.8	246.4
		Btu/h	783,400	802,500	821,700	840,800
	Heating (Rated)	kW	255.6	260.6	266.9	273.2
		Btu/h	872,300	889,200	910,700	932,200
Input	Cooling (Rated)	kW	56.27	58.18	59.39	61.07
	Heating (Rated)	kW	63.30	64.60	66.32	68.13
Input	Cooling (Rated)	kW	67.8	69.9	71.7	74.3
	Heating (Rated)	kW	58.4	60.3	61.9	64.3
	Heating (Max.)	kW	69.2	71.5	73.4	76.4
EER (Rated)			4.08	4.04	4.05	4.03
COP (Rated)			4.04	4.03	4.02	4.01
EER			3.38	3.37	3.36	3.32
ESEER			5.75	5.72	5.68	5.59
ESEER (SLC)			6.91	6.95	6.86	6.79
Power Factor	Rated	-	0.93	0.93	0.93	0.93
Exterior	Color		Warm Gray / Dawn Gray	Warm Gray / Dawn Gray	Warm Gray / Dawn Gray	Warm Gray / Dawn Gray
	RAL code		NL503K / NA507K	NL503K / NA507K	NL503K / NA507K	NL503K / NA507K
Heat Exchanger			Wide Louver Plus	Wide Louver Plus	Wide Louver Plus	Wide Louver Plus
Compressor	Motor Output x Number	W x No.	5,300 x 7	5,300 x 7	5,300 x 7	5,300 x 7
	Type		Propeller fan	Propeller fan	Propeller fan	Propeller fan
Fan	Motor Output x Number	W	(900 x 6) + (1,200 x 1)	(900 x 6) + (1,200 x 1)	900 x 8	900 x 8
	Air Flow Rate (High)	m ³ /min	(320 x 3) + (240 x 1)	(320 x 3) + (240 x 1)	320 x 4	320 x 4
		ft ³ /min	(11,301 x 3) + (8,476 x 1)	(11,301 x 3) + (8,476 x 1)	11,301 x 4	11,301 x 4
	External Static Pressure (Max, Pa)		80	80	80	80
Pipe Connctions	Liquid Pipe	mm (inch)	22.2 (7/8)	22.2 (7/8)	22.2 (7/8)	22.2 (7/8)
	Gas Pipe	mm (inch)	53.98 (2-1/8)	53.98 (2-1/8)	53.98 (2-1/8)	53.98 (2-1/8)
Dimensions (W x H x D)			(1,240 x 1,690 x 760) x 3 + (930 x 1,690 x 760) x 1	(1,240 x 1,690 x 760) x 3 + (930 x 1,690 x 760) x 1	(1,240 x 1,690 x 760) x 4	(1,240 x 1,690 x 760) x 4
Net Weight		kg	(283 x 2) + (281 x 1) + (199 x 1)	(283 x 3) + (199 x 1)	(283 x 3) + (221 x 1)	(283 x 3) + (221 x 1)
		lbs	(624 x 2) + (619 x 1) + (439 x 1)	(624 x 3) + (439 x 1)	(624 x 3) + (487 x 1)	(624 x 3) + (487 x 1)
Sound Pressure Level	Cooling	dB(A)	70.1	70.2	70.2	70.3
	Heating	dB(A)	71.6	72.1	72.1	72.2
Sound Power Level	Cooling	dB(A)	92.4	92.9	93.1	93.2
	Heating	dB(A)	94.4	94.9	95.1	95.2
Communication Cable		No. x mm ² (VCTF-SB)	2C x 1.0 - 1.5	2C x 1.0 - 1.5	2C x 1.0 - 1.5	2C x 1.0 - 1.5
Refrigerant	Refrigerant Name		R410A	R410A	R410A	R410A
	Precharged Amount in factory	kg	16.0 + 16.0 + 14.0 + 10.0	16.0 + 16.0 + 16.0 + 10.0	16.0 + 16.0 + 16.0 + 13.0	16.0 + 16.0 + 16.0 + 13.0
		lbs	35.3 + 35.3 + 30.9 + 22.0	35.3 + 35.3 + 35.3 + 22.0	35.3 + 35.3 + 35.3 + 28.7	35.3 + 35.3 + 35.3 + 28.7
	t-CO ₂ eq		116.9	121.1	127.3	127.3
Control			Electronic Expansion Valve	Electronic Expansion Valve	Electronic Expansion Valve	Electronic Expansion Valve
Power Supply	∅, V, Hz		3, 380 - 415, 50	3, 380 - 415, 50	3, 380 - 415, 50	3, 380 - 415, 50
			3, 380, 60	3, 380, 60	3, 380, 60	3, 380, 60
Number of Maxmum Connectable Indoor Units			64	64	64	64

Note : 1. Due to our policy of innovation some specifications may be changed without notification.
 2. Wiring cable size must comply with the applicable local and national codes. And "Electric characteristics" chapter should be considered for electrical work and design. Especially the power cable and circuit breaker should be selected in accordance with that.
 3. Power factor could vary less than ±1% according to the operating conditions.
 4. Sound pressure level is measured on the rated condition in the anechoic rooms by ISO 3745 standard. Sound power level is measured on the rated condition in the reverberation rooms by ISO 3741 standard. Therefore, these values can be increased owing to ambient conditions during operation.
 5. Performances are based on the following conditions : Cooling : Indoor Ambient Temp. 27°CDB / 19°CWB, Outdoor Ambient Temp. 35°CDB / 24°CWB
 Heating : Indoor Ambient Temp. 20°CDB / 15°CWB, Outdoor Ambient Temp. 7°CDB / 6°CWB
 Interconnected Pipe Length is 7.5m and difference of Elevation (Outdoor - Indoor Unit) is Zero.
 6. The numbers in parentheses means maximum connectable indoor units in accordance with outdoor units combination. The recommended ratio is 130%.
 7. This product contains Fluorinated greenhouse gases.(R410A, GWP(Global warming potential) = 2087.5)
 ※ Eurovent test Condition

Non TROPICAL MODEL

STANDARD

ARUN900LTE5 / ARUN920LTE5 / ARUN940LTE5 / ARUN960LTE5



HP			90	92	94	96
Model Name	Combination Unit		ARUN900LTE5	ARUN920LTE5	ARUN940LTE5	ARUN960LTE5
	Independent Unit		ARUN240LTE5 ARUN240LTE5 ARUN240LTE5 ARUN180LTE5	ARUN240LTE5 ARUN240LTE5 ARUN240LTE5 ARUN200LTE5	ARUN240LTE5 ARUN240LTE5 ARUN240LTE5 ARUN220LTE5	ARUN240LTE5 ARUN240LTE5 ARUN240LTE5 ARUN240LTE5
Capacity	Cooling (Rated)	kW	252.0	257.6	263.2	268.8
		Btu/h	859,900	879,000	898,100	917,200
	Heating (Rated)	kW	279.5	285.8	292.1	297.0
		Btu/h	953,700	975,200	996,700	1,013,600
Input	Cooling (Rated)	kW	61.23	62.58	65.12	67.03
	Heating (Rated)	kW	68.60	72.06	74.08	75.39
Input	Cooling (Rated)	kW	74.3	76.5	79.9	82.0
	Heating (Rated)	kW	64.2	66.5	68.6	70.6
	Heating (Max.)	kW	75.9	78.9	81.2	83.5
EER (Rated)			4.12	4.12	4.04	4.01
COP (Rated)			4.07	3.97	3.94	3.94
EER			3.39	3.37	3.29	3.28
ESEER			5.71	5.66	5.61	5.58
ESEER (SLC)			6.83	6.76	6.80	6.83
Power Factor	Rated	-	0.93	0.93	0.93	0.93
Exterior	Color		Warm Gray / Dawn Gray	Warm Gray / Dawn Gray	Warm Gray / Dawn Gray	Warm Gray / Dawn Gray
	RAL code		NL503K / NA507K	NL503K / NA507K	NL503K / NA507K	NL503K / NA507K
Heat Exchanger			Wide Louver Plus	Wide Louver Plus	Wide Louver Plus	Wide Louver Plus
Compressor	Motor Output x Number	W x No.	(5,300 x 7) + (4,200 x 1)	5,300 x 8	5,300 x 8	5,300 x 8
	Type		Propeller fan	Propeller fan	Propeller fan	Propeller fan
Fan	Motor Output x Number	W	900 x 8	900 x 8	900 x 8	900 x 8
	Air Flow Rate (High)	m ³ /min	320 x 4	320 x 4	320 x 4	320 x 4
		ft ³ /min	11,301 x 4	11,301 x 4	11,301 x 4	11,301 x 4
	External Static Pressure (Max, Pa)		80	80	80	80
Pipe Connctions	Liquid Pipe	mm (inch)	22.2 (7/8)	22.2 (7/8)	22.2 (7/8)	22.2 (7/8)
	Gas Pipe	mm (inch)	53.98 (2-1/8)	53.98 (2-1/8)	53.98 (2-1/8)	53.98 (2-1/8)
Dimensions (W x H x D)			(1,240 x 1,690 x 760) x 4	(1,240 x 1,690 x 760) x 4	(1,240 x 1,690 x 760) x 4	(1,240 x 1,690 x 760) x 4
Net Weight		kg	(283 x 3) + (261 x 1)	(283 x 3) + (281 x 1)	(283 x 3) + (281 x 1)	283 x 4
		lbs	(624 x 3) + (575 x 1)	(624 x 3) + (619 x 1)	(624 x 3) + (619 x 1)	624 x 4
Sound Pressure Level	Cooling	dB(A)	70.3	70.4	70.9	71.0
	Heating	dB(A)	72.2	72.5	72.7	73.0
Sound Power Level	Cooling	dB(A)	93.4	93.6	93.6	94.0
	Heating	dB(A)	95.3	95.4	95.6	96.0
Communication Cable		No. x mm ² (VCTF-SB)	2C x 1.0 - 1.5	2C x 1.0 - 1.5	2C x 1.0 - 1.5	2C x 1.0 - 1.5
Refrigerant	Refrigerant Name		R410A	R410A	R410A	R410A
	Precharged Amount in factory	kg	16.0 + 16.0 + 16.0 + 13.0	16.0 + 16.0 + 16.0 + 14.0	16.0 + 16.0 + 16.0 + 14.0	16.0 + 16.0 + 16.0 + 16.0
		lbs	35.3 + 35.3 + 35.3 + 28.7	35.3 + 35.3 + 35.3 + 30.9	35.3 + 35.3 + 35.3 + 30.9	35.3 + 35.3 + 35.3 + 35.3
	t-CO ₂ eq		127.3	129.4	129.4	133.6
Control			Electronic Expansion Valve	Electronic Expansion Valve	Electronic Expansion Valve	Electronic Expansion Valve
Power Supply	∅, V, Hz		3, 380 - 415, 50	3, 380 - 415, 50	3, 380 - 415, 50	3, 380 - 415, 50
			3, 380, 60	3, 380, 60	3, 380, 60	3, 380, 60
Number of Maxmum Connectable Indoor Units			64	64	64	64

Note : 1. Due to our policy of innovation some specifications may be changed without notification.
 2. Wiring cable size must comply with the applicable local and national codes. And "Electric characteristics" chapter should be considered for electrical work and design. Especially the power cable and circuit breaker should be selected in accordance with that.
 3. Power factor could vary less than ±1% according to the operating conditions.
 4. Sound pressure level is measured on the rated condition in the anechoic rooms by ISO 3745 standard. Sound power level is measured on the rated condition in the reverberation rooms by ISO 3741 standard. Therefore, these values can be increased owing to ambient conditions during operation.
 5. Performances are based on the following conditions : Cooling : Indoor Ambient Temp. 27°CDB / 19°CWB, Outdoor Ambient Temp. 35°CDB / 24°CWB
 Heating : Indoor Ambient Temp. 20°CDB / 15°CWB, Outdoor Ambient Temp. 7°CDB / 6°CWB
 Interconnected Pipe Length is 7.5m and difference of Elevation (Outdoor - Indoor Unit) is Zero.
 6. The numbers in parentheses means maximum connectable indoor units in accordance with outdoor units combination. The recommended ratio is 130%.
 7. This product contains Fluorinated greenhouse gases.(R410A, GWP(Global warming potential) = 2087.5)
 ※ Eurovent test Condition

MULTI V 5

TROPICAL MODEL

HIGH EFFICIENCY

ARUN080LEH5 / ARUN100LEH5 / ARUN120LEH5 / ARUN140LEH5



HP			8	10	12	14
Model Name	Combination Unit		ARUN080LEH5	ARUN100LEH5	ARUN120LEH5	ARUN140LEH5
	Independent Unit		ARUN080LEH5	ARUN100LEH5	ARUN120LEH5	ARUN140LEH5
Capacity (Rated)	*Cooling - T1 35°C	RT	6.4	8.0	9.5	11.1
		kW	22.4	28.0	33.6	39.2
		Btu/h	76,400	95,500	114,600	133,800
	**Cooling - T3 46°C	RT	5.7	7.2	9.4	11.0
		kW	20.2	25.5	33.0	38.8
		Btu/h	68,800	87,000	112,600	132,400
	Heating	RT	7.2	8.9	10.7	12.5
		kW	25.2	31.5	37.8	43.9
		Btu/h	86,000	107,500	129,000	149,900
Input (Rated)	*Cooling - T1 35°C	kW	4.52	5.58	7.53	9.10
	**Cooling - T3 46°C	kW	6.20	7.75	9.60	11.78
	Heating	kW	4.88	5.68	7.58	9.69
COP	*Cooling - T1 35°C	kW/kW	4.96	5.02	4.46	4.31
	**Cooling - T3 46°C	kW/kW	3.25	3.29	3.44	3.29
	Heating	kW/kW	5.16	5.55	4.99	4.53
Power Factor	Rated	-	0.93	0.93	0.93	0.93
Casing	Color		Warm Gray / Dawn Gray	Warm Gray / Dawn Gray	Warm Gray / Dawn Gray	Warm Gray / Dawn Gray
Heat Exchanger			Wide Louver Plus	Wide Louver Plus	Wide Louver Plus	Wide Louver Plus
Compressor	Type		Hermetically Sealed Scroll	Hermetically Sealed Scroll	Hermetically Sealed Scroll	Hermetically Sealed Scroll
	Piston Displacement	cm ³ /rev	62	62	62	62
	Number of Revolution	rev/min	3,600	3,600	3,600	3,600
	Motor Output x Number	W x No.	5,300 x 1	5,300 x 1	5,300 x 1	5,300 x 1
	Starting Method		Direct On Line	Direct On Line	Direct On Line	Direct On Line
	Oil Type		FVC68D (PVE)	FVC68D (PVE)	FVC68D (PVE)	FVC68D (PVE)
	Type		Propeller fan	Propeller fan	Propeller fan	Propeller fan
Fan	Motor Output x Number	W	1,200 x 1	1,200 x 1	900 x 2	900 x 2
	Air Flow Rate (High)	m ³ /min	240 x 1	240 x 1	320 x 1	320 x 1
		ft ³ /min	8,476 x 1	8,476 x 1	11,301 x 1	11,301 x 1
	Drive		DC INVERTER	DC INVERTER	DC INVERTER	DC INVERTER
Pipe Connctions	Liquid Pipe	mm (inch)	9.52 (3/8)	9.52 (3/8)	12.7 (1/2)	12.7 (1/2)
	Gas Pipe	mm (inch)	19.05 (3/4)	22.2 (7/8)	28.58 (1-1/8)	28.58 (1-1/8)
Dimensions (W x H x D)	mm		(930 x 1,690 x 760) x 1	(930 x 1,690 x 760) x 1	(1,240 x 1,690 x 760) x 1	(1,240 x 1,690 x 760) x 1
	inch		(36-5/8 x 66-17/32 x 29-29/32) x 1	(36-5/8 x 66-17/32 x 29-29/32) x 1	(48-13/16 x 66-17/32 x 29-29/32) x 1	(48-13/16 x 66-17/32 x 29-29/32) x 1
Net Weight	kg		200 x 1	200 x 1	221 x 1	221 x 1
	lbs		441 x 1	441 x 1	487 x 1	487 x 1
Sound Pressure Level	Cooling	dB(A)	58.0	58.0	59.0	60.0
	Heating	dB(A)	59.0	59.0	60.0	61.0
Sound Power Level	Cooling	dB(A)	77.0	78.0	79.0	82.0
	Heating	dB(A)	78.0	79.0	80.0	84.0
Communication Cable	No. x mm ² (VCTF-SB)		2C x 1.0 - 1.5	2C x 1.0 - 1.5	2C x 1.0 - 1.5	2C x 1.0 - 1.5
Refrigerant	Refrigerant Name		R410A	R410A	R410A	R410A
	Precharged Amount	kg	10.0	10.0	13.0	13.0
		lbs	22.0	22.0	28.7	28.7
Control		Electronic Expansion Valve	Electronic Expansion Valve	Electronic Expansion Valve	Electronic Expansion Valve	
Power Supply	∅, V, Hz		3, 380 - 415, 50	3, 380 - 415, 50	3, 380 - 415, 50	3, 380 - 415, 50
Number of Maximum Connectable Indoor Units			13 (20)	16 (25)	23 (35)	23 (35)

TROPICAL MODEL

HIGH EFFICIENCY

ARUN160LEH5 / ARUN180LEH5 / ARUN200LEH5 / ARUN220LEH5



HP			16	18	20	22
Model Name	Combination Unit		ARUN160LEH5	ARUN180LEH5	ARUN200LEH5	ARUN220LEH5
	Independent Unit		ARUN160LEH5	ARUN180LEH5	ARUN200LEH5	ARUN120LEH5 ARUN100LEH5
Capacity (Rated)	*Cooling - T1 35°C	RT	12.7	14.3	15.9	17.5
		kW	44.8	50.4	56.0	61.6
		Btu/h	152,900	172,000	191,100	210,200
	**Cooling - T3 46°C	RT	11.5	12.9	13.9	16.6
		kW	40.3	45.4	49.0	58.5
		Btu/h	137,600	154,900	167,200	199,600
	Heating	RT	14.2	16.1	17.9	19.7
		kW	50.0	56.7	63.0	69.3
		Btu/h	170,600	193,500	215,000	236,500
Input (Rated)	*Cooling - T1 35°C	kW	9.87	10.72	12.50	13.11
	**Cooling - T3 46°C	kW	12.80	13.91	15.77	17.35
	Heating	kW	10.30	13.34	15.52	13.26
COP	*Cooling - T1 35°C	kW/kW	4.54	4.70	4.48	4.70
	**Cooling - T3 46°C	kW/kW	3.15	3.26	3.11	3.37
	Heating	kW/kW	4.85	4.25	4.06	5.23
Power Factor	Rated	-	0.93	0.93	0.93	0.93
Casing	Color		Warm Gray / Dawn Gray	Warm Gray / Dawn Gray	Warm Gray / Dawn Gray	Warm Gray / Dawn Gray
Heat Exchanger			Wide Louver Plus	Wide Louver Plus	Wide Louver Plus	Wide Louver Plus
Compressor	Type		Hermetically Sealed Scroll	Hermetically Sealed Scroll	Hermetically Sealed Scroll	Hermetically Sealed Scroll
	Piston Displacement	cm ³ /rev	62.1 x 1 + 43.8 x 1	62.1 x 2	62.1 x 2	62.1 x 2
	Number of Revolution	rev/min	3,600 x 2	3,600 x 2	3,600 x 2	3,600 x 2
	Motor Output x Number	W x No.	5,300 x 1 + 4,200 x 1	5,300 x 2	5,300 x 2	5,300 x 2
	Starting Method		Direct On Line	Direct On Line	Direct On Line	Direct On Line
	Oil Type		FVC68D (PVE)	FVC68D (PVE)	FVC68D (PVE)	FVC68D (PVE)
	Type		Propeller fan	Propeller fan	Propeller fan	Propeller fan
Fan	Motor Output x Number	W	900 x 2	900 x 2	900 x 2	(900 x 2) + (1,200 x 1)
	Air Flow Rate (High)	m ³ /min	320 x 1	320 x 1	320 x 1	(320 x 1) + (240 x 1)
		ft ³ /min	11,301 x 1	11,301 x 1	11,301 x 1	(11,301 x 1) + (8,476 x 1)
	Drive		DC INVERTER	DC INVERTER	DC INVERTER	DC INVERTER
Pipe Connctions	Liquid Pipe	mm (inch)	12.7 (1/2)	15.88 (5/8)	15.88 (5/8)	15.88 (5/8)
	Gas Pipe	mm (inch)	28.58 (1-1/8)	28.58 (1-1/8)	28.58 (1-1/8)	28.58 (1-1/8)
Dimensions (W x H x D)	mm		(1,240 x 1,690 x 760) x 1	(1,240 x 1,690 x 760) x 1	(1,240 x 1,690 x 760) x 1	(1,240 x 1,690 x 760) x 1 + (930 x 1,690 x 760) x 1
	inch		(48-13/16 x 66-17/32 x 29-29/32) x 1	(48-13/16 x 66-17/32 x 29-29/32) x 1	(48-13/16 x 66-17/32 x 29-29/32) x 1	(48-13/16 x 66-17/32 x 29-29/32) x 1 + (36-5/8 x 66-17/32 x 29-29/32) x 1
Net Weight	kg		261 x 1	281 x 1	281 x 1	(221 x 1) + (200 x 1)
	lbs		575 x 1	619 x 1	619 x 1	(487 x 1) + (441 x 1)
Sound Pressure Level	Cooling	dB(A)	60.5	61.0	62.0	61.5
	Heating	dB(A)	61.5	62.0	64.5	62.5
Sound Power Level	Cooling	dB(A)	83.0	85.0	86.0	81.5
	Heating	dB(A)	85.0	86.0	87.0	82.5
Communication Cable	No. x mm ² (VCTF-SB)		2C x 1.0 - 1.5	2C x 1.0 - 1.5	2C x 1.0 - 1.5	2C x 1.0 - 1.5
Refrigerant	Refrigerant Name		R410A	R410A	R410A	R410A
	Precharged Amount	kg	12.0	14.0	14.0	23.0
		lbs	26.5	30.9	30.9	50.7
Control		Electronic Expansion Valve	Electronic Expansion Valve	Electronic Expansion Valve	Electronic Expansion Valve	
Power Supply	∅, V, Hz		3, 380 - 415, 50	3, 380 - 415, 50	3, 380 - 415, 50	3, 380 - 415, 50
Number of Maximum Connectable Indoor Units			26 (40)	29 (45)	32 (50)	35 (56)

MULTI V 5

TROPICAL MODEL

HIGH EFFICIENCY

ARUN240LEH5 / ARUN260LEH5 / ARUN280LEH5 / ARUN300LEH5



HP			24	26	28	30
Model Name	Combination Unit		ARUN240LEH5	ARUN260LEH5	ARUN280LEH5	ARUN300LEH5
	Independent Unit		ARUN140LEH5 ARUN100LEH5	ARUN140LEH5 ARUN120LEH5	ARUN140LEH5 ARUN140LEH5	ARUN160LEH5 ARUN140LEH5
			2	2	2	2
Capacity (Rated)	*Cooling - T1 35°C	RT	19.1	20.7	22.3	23.9
		kW	67.2	72.8	78.4	84.0
		Btu/h	229,300	248,400	267,500	286,600
	**Cooling - T3 46°C	RT	18.3	20.4	22.0	22.5
		kW	64.3	71.8	77.6	79.1
		Btu/h	219,400	245,000	264,800	270,000
	Heating	RT	21.4	23.2	24.9	26.7
		kW	75.4	81.7	87.8	93.9
		Btu/h	257,300	278,800	299,700	320,500
Input (Rated)	*Cooling - T1 35°C	kW	14.68	16.63	18.20	18.97
	**Cooling - T3 46°C	kW	19.53	21.38	23.56	24.58
	Heating	kW	15.37	17.27	19.38	19.99
COP	*Cooling - T1 35°C	kW/kW	4.58	4.38	4.31	4.43
	**Cooling - T3 46°C	kW/kW	3.29	3.36	3.29	3.22
	Heating	kW/kW	4.91	4.73	4.53	4.70
Power Factor	Rated	-	0.93	0.93	0.93	0.93
Casing	Color		Warm Gray / Dawn Gray	Warm Gray / Dawn Gray	Warm Gray / Dawn Gray	Warm Gray / Dawn Gray
Heat Exchanger			Wide Louver Plus	Wide Louver Plus	Wide Louver Plus	Wide Louver Plus
Compressor	Type		Hermetically Sealed Scroll	Hermetically Sealed Scroll	Hermetically Sealed Scroll	Hermetically Sealed Scroll
	Piston Displacement	cm ³ /rev	62.1 x 2	62.1 x 2	62.1 x 2	(62.1 x 2) + (43.8 x 1)
	Number of Revolution	rev/min	3,600 x 2	3,600 x 2	3,600 x 2	3,600 x 3
	Motor Output x Number	W x No.	5,300 x 2	5,300 x 2	5,300 x 2	(5,300 x 2) + (4,200 x 1)
	Starting Method		Direct On Line	Direct On Line	Direct On Line	Direct On Line
	Oil Type		FVC68D (PVE)	FVC68D (PVE)	FVC68D (PVE)	FVC68D (PVE)
Fan	Type		Propeller fan	Propeller fan	Propeller fan	Propeller fan
	Motor Output x Number	W	(900 x 2) + (1,200 x 1)	900 x 4	900 x 4	900 x 4
	Air Flow Rate (High)	m ³ /min	(320 x 1) + (240 x 1)	320 x 2	320 x 2	320 x 2
		ft ³ /min	(11,301 x 1) + (8,476 x 1)	11,301 x 2	11,301 x 2	11,301 x 2
	Drive		DC INVERTER	DC INVERTER	DC INVERTER	DC INVERTER
	Discharge	Side / Top	TOP	TOP	TOP	TOP
Pipe Connctions	Liquid Pipe	mm (inch)	15.88 (5/8)	19.05 (3/4)	19.05 (3/4)	19.05 (3/4)
	Gas Pipe	mm (inch)	34.9 (1-3/8)	34.9 (1-3/8)	34.9 (1-3/8)	34.9 (1-3/8)
Dimensions (W x H x D)		mm	(1,240 x 1,690 x 760) x 1 + (930 x 1,690 x 760) x 1	(1,240 x 1,690 x 760) x 2	(1,240 x 1,690 x 760) x 2	(1,240 x 1,690 x 760) x 2
		inch	(48-13/16 x 66-17/32 x 29-29/32) x 1 + (36-5/8 x 66-17/32 x 29-29/32) x 1	(48-13/16 x 66-17/32 x 29-29/32) x 2	(48-13/16 x 66-17/32 x 29-29/32) x 2	(48-13/16 x 66-17/32 x 29-29/32) x 2
Net Weight		kg	(221 x 1) + (200 x 1)	221 x 2	221 x 2	(261 x 1) + (221 x 1)
		lbs	(487 x 1) + (441 x 1)	487 x 2	487 x 2	(575 x 1) + (487 x 1)
Sound Pressure Level	Cooling	dB(A)	62.1	62.5	63.0	63.3
	Heating	dB(A)	63.1	63.5	64.0	64.3
Sound Power Level	Cooling	dB(A)	83.5	83.8	85.0	85.5
	Heating	dB(A)	85.2	85.5	87.0	87.5
Communication Cable	No. x mm ² (VCTF-SB)		2C x 1.0 - 1.5	2C x 1.0 - 1.5	2C x 1.0 - 1.5	2C x 1.0 - 1.5
Refrigerant	Refrigerant Name		R410A	R410A	R410A	R410A
	Precharged Amount	kg	23.0	26.0	26.0	25.0
		lbs	50.7	57.4	57.4	55.2
	Control		Electronic Expansion Valve	Electronic Expansion Valve	Electronic Expansion Valve	Electronic Expansion Valve
Power Supply	∅, V, Hz		3, 380 - 415, 50	3, 380 - 415, 50	3, 380 - 415, 50	3, 380 - 415, 50
			3, 400, 60	3, 400, 60	3, 400, 60	3, 400, 60
Number of Maximum Connectable Indoor Units			39 (48)	42 (52)	45 (56)	49 (60)

TROPICAL MODEL

HIGH EFFICIENCY

ARUN320LEH5 / ARUN340LEH5 / ARUN360LEH5 / ARUN380LEH5



HP			32	34	36	38
Model Name	Combination Unit		ARUN320LEH5	ARUN340LEH5	ARUN360LEH5	ARUN380LEH5
	Independent Unit		ARUN180LEH5 ARUN140LEH5	ARUN200LEH5 ARUN140LEH5	ARUN200LEH5 ARUN160LEH5	ARUN200LEH5 ARUN180LEH5
			2	2	2	2
Capacity (Rated)	*Cooling - T1 35°C	RT	25.4	27.0	28.6	30.2
		kW	89.6	95.2	100.8	106.4
		Btu/h	305,700	324,800	343,900	363,000
	**Cooling - T3 46°C	RT	23.9	24.9	25.4	26.8
		kW	84.2	87.8	89.3	94.4
		Btu/h	287,300	299,600	304,800	322,100
	Heating	RT	28.6	30.4	32.1	34.0
		kW	100.6	106.9	113.0	119.7
		Btu/h	343,300	364,800	385,600	408,400
Input (Rated)	*Cooling - T1 35°C	kW	19.82	21.60	22.37	23.22
	**Cooling - T3 46°C	kW	25.69	27.55	28.57	29.68
	Heating	kW	23.03	25.21	25.82	28.86
COP	*Cooling - T1 35°C	kW/kW	4.52	4.41	4.51	4.58
	**Cooling - T3 46°C	kW/kW	3.28	3.19	3.13	3.18
	Heating	kW/kW	4.37	4.24	4.38	4.15
Power Factor	Rated	-	0.93	0.93	0.93	0.93
Casing	Color		Warm Gray / Dawn Gray	Warm Gray / Dawn Gray	Warm Gray / Dawn Gray	Warm Gray / Dawn Gray
Heat Exchanger			Wide Louver Plus	Wide Louver Plus	Wide Louver Plus	Wide Louver Plus
Compressor	Type		Hermetically Sealed Scroll	Hermetically Sealed Scroll	Hermetically Sealed Scroll	Hermetically Sealed Scroll
	Piston Displacement	cm ³ /rev	62.1 x 3	62.1 x 3	(62.1 x 3) + (43.8 x 1)	62.1 x 4
	Number of Revolution	rev/min	3,600 x 3	3,600 x 3	3,600 x 4	3,600 x 4
	Motor Output x Number	W x No.	5,300 x 3	5,300 x 3	(5,300 x 3) + (4,200 x 1)	5,300 x 4
	Starting Method		Direct On Line	Direct On Line	Direct On Line	Direct On Line
	Oil Type		FVC68D (PVE)	FVC68D (PVE)	FVC68D (PVE)	FVC68D (PVE)
Fan	Type		Propeller fan	Propeller fan	Propeller fan	Propeller fan
	Motor Output x Number	W	900 x 4	900 x 4	900 x 4	900 x 4
	Air Flow Rate (High)	m ³ /min	320 x 2	320 x 2	320 x 2	320 x 2
		ft ³ /min	11,301 x 2	11,301 x 2	11,301 x 2	11,301 x 2
	Drive		DC INVERTER	DC INVERTER	DC INVERTER	DC INVERTER
	Discharge	Side / Top	TOP	TOP	TOP	TOP
Pipe Connctions	Liquid Pipe	mm (inch)	19.05 (3/4)	19.05 (3/4)	19.05 (3/4)	19.05 (3/4)
	Gas Pipe	mm (inch)	34.9 (1-3/8)	34.9 (1-3/8)	41.3 (1-5/8)	41.3 (1-5/8)
Dimensions (W x H x D)		mm	(1,240 x 1,690 x 760) x 2	(1,240 x 1,690 x 760) x 2	(1,240 x 1,690 x 760) x 2	(1,240 x 1,690 x 760) x 2
		inch	(48-13/16 x 66-17/32 x 29-29/32) x 2	(48-13/16 x 66-17/32 x 29-29/32) x 2	(48-13/16 x 66-17/32 x 29-29/32) x 2	(48-13/16 x 66-17/32 x 29-29/32) x 2
Net Weight		kg	(281 x 1) + (221 x 1)	(281 x 1) + (221 x 1)	(281 x 1) + (261 x 1)	281 x 2
		lbs	(619 x 1) + (487 x 1)	(619 x 1) + (487 x 1)	(619 x 1) + (575 x 1)	619 x 2
Sound Pressure Level	Cooling	dB(A)	63.5	64.1	64.3	64.5
	Heating	dB(A)	64.5	66.1	66.3	66.4
Sound Power Level	Cooling	dB(A)	86.8	87.5	87.8	88.5
	Heating	dB(A)	88.1	88.8	89.1	89.5
Communication Cable	No. x mm ² (VCTF-SB)		2C x 1.0 - 1.5	2C x 1.0 - 1.5	2C x 1.0 - 1.5	2C x 1.0 - 1.5
Refrigerant	Refrigerant Name		R410A	R410A	R410A	R410A
	Precharged Amount	kg	27.0	27.0	26.0	28.0
		lbs	59.6	59.6	57.4	61.8
Control		Electronic Expansion Valve	Electronic Expansion Valve	Electronic Expansion Valve	Electronic Expansion Valve	
Power Supply	∅, V, Hz		3, 380 - 415, 50	3, 380 - 415, 50	3, 380 - 415, 50	3, 380 - 415, 50
			3, 400, 60	3, 400, 60	3, 400, 60	3, 400, 60
Number of Maximum Connectable Indoor Units			52 (64)	55 (64)	58 (64)	61 (64)

MULTI V 5

TROPICAL MODEL

HIGH EFFICIENCY

ARUN400LEH5 / ARUN420LEH5 / ARUN440LEH5 / ARUN460LEH5



HP			40	42	44	46
Model Name	Combination Unit		ARUN400LEH5	ARUN420LEH5	ARUN440LEH5	ARUN460LEH5
	Independent Unit		ARUN200LEH5 ARUN200LEH5	ARUN140LEH5 ARUN140LEH5 ARUN140LEH5	ARUN160LEH5 ARUN140LEH5 ARUN140LEH5	ARUN180LEH5 ARUN140LEH5 ARUN140LEH5
			2	3	3	3
Capacity (Rated)	*Cooling - T1 35°C	RT	31.8	33.4	35.0	36.6
		kW	112.0	117.6	123.2	128.8
		Btu/h	382,100	401,300	420,400	439,500
	**Cooling - T3 46°C	RT	27.8	33.1	33.5	34.9
		kW	98.0	116.4	117.9	123.0
		Btu/h	334,400	397,200	402,300	419,700
Heating	RT	35.8	37.4	39.1	41.0	
	kW	126.0	131.8	137.8	144.5	
	Btu/h	429,900	449,600	470,300	493,200	
Input (Rated)	*Cooling - T1 35°C	kW	25.00	27.30	28.07	28.92
	**Cooling - T3 46°C	kW	31.54	35.34	36.36	37.47
	Heating	kW	31.04	29.07	29.68	32.72
COP	*Cooling - T1 35°C	kW/kW	4.48	4.31	4.39	4.45
	**Cooling - T3 46°C	kW/kW	3.11	3.29	3.24	3.28
	Heating	kW/kW	4.06	4.53	4.64	4.42
Power Factor	Rated	-	0.93	0.93	0.93	0.93
Casing	Color		Warm Gray / Dawn Gray	Warm Gray / Dawn Gray	Warm Gray / Dawn Gray	Warm Gray / Dawn Gray
Heat Exchanger			Wide Louver Plus	Wide Louver Plus	Wide Louver Plus	Wide Louver Plus
Compressor	Type		Hermetically Sealed Scroll	Hermetically Sealed Scroll	Hermetically Sealed Scroll	Hermetically Sealed Scroll
	Piston Displacement	cm ³ /rev	62.1 x 4	62.1 x 3	(62.1 x 3) + (43.8 x 1)	62.1 x 4
	Number of Revolution	rev/min	3,600 x 4	3,600 x 3	3,600 x 4	3,600 x 4
	Motor Output x Number	W x No.	5,300 x 4	5,300 x 3	(5,300 x 3) + (4,200 x 1)	5,300 x 4
	Starting Method		Direct On Line	Direct On Line	Direct On Line	Direct On Line
	Oil Type		FVC68D (PVE)	FVC68D (PVE)	FVC68D (PVE)	FVC68D (PVE)
Fan	Type		Propeller fan	Propeller fan	Propeller fan	Propeller fan
	Motor Output x Number	W	900 x 4	900 x 6	900 x 6	900 x 6
	Air Flow Rate (High)	m ³ /min	320 x 2	320 x 3	320 x 3	320 x 3
		ft ³ /min	11,301 x 2	11,301 x 3	11,301 x 3	11,301 x 3
	Drive		DC INVERTER	DC INVERTER	DC INVERTER	DC INVERTER
Pipe Connctions	Discharge	Side / Top	TOP	TOP	TOP	TOP
	Liquid Pipe	mm (inch)	19.05 (3/4)	19.05 (3/4)	19.05 (3/4)	19.05 (3/4)
	Gas Pipe	mm (inch)	41.3 (1-5/8)	41.3 (1-5/8)	41.3 (1-5/8)	41.3 (1-5/8)
Dimensions (W x H x D)		mm	(1,240 x 1,690 x 760) x 2	(1,240 x 1,690 x 760) x 3	(1,240 x 1,690 x 760) x 3	(1,240 x 1,690 x 760) x 3
		inch	(48-13/16 x 66-17/32 x 29-29/32) x 2	(48-13/16 x 66-17/32 x 29-29/32) x 3	(48-13/16 x 66-17/32 x 29-29/32) x 3	(48-13/16 x 66-17/32 x 29-29/32) x 3
Net Weight		kg	281 x 2	221 x 3	(261 x 1) + (221 x 2)	(281 x 1) + (221 x 2)
		lbs	619 x 2	487 x 3	(575 x 1) + (487 x 2)	(619 x 1) + (487 x 2)
Sound Pressure Level	Cooling	dB(A)	65.0	64.8	64.9	65.1
	Heating	dB(A)	67.5	65.8	65.9	66.1
Sound Power Level	Cooling	dB(A)	89.0	86.8	87.1	88.0
	Heating	dB(A)	90.0	88.8	89.1	89.5
Communication Cable		No. x mm ² (VCTF-SB)	2C x 1.0 - 1.5	2C x 1.0 - 1.5	2C x 1.0 - 1.5	2C x 1.0 - 1.5
Refrigerant	Refrigerant Name		R410A	R410A	R410A	R410A
	Precharged Amount	kg	28.0	39.0	38.0	40.0
		lbs	61.8	86.1	83.9	88.3
	Control		Electronic Expansion Valve	Electronic Expansion Valve	Electronic Expansion Valve	Electronic Expansion Valve
Power Supply		∅, V, Hz	3, 380 - 415, 50	3, 380 - 415, 50	3, 380 - 415, 50	3, 380 - 415, 50
			3, 400, 60	3, 400, 60	3, 400, 60	3, 400, 60
Number of Maximum Connectable Indoor Units			64	64	64	64

TROPICAL MODEL

HIGH EFFICIENCY

ARUN480LEH5 / ARUN500LEH5 / ARUN520LEH5 / ARUN540LEH5



HP			48	50	52	54
Model Name	Combination Unit		ARUN480LEH5	ARUN500LEH5	ARUN520LEH5	ARUN540LEH5
	Independent Unit		ARUN200LEH5 ARUN140LEH5 ARUN140LEH5	ARUN200LEH5 ARUN160LEH5 ARUN140LEH5	ARUN200LEH5 ARUN180LEH5 ARUN140LEH5	ARUN200LEH5 ARUN200LEH5 ARUN140LEH5
			3	3	3	3
Capacity (Rated)	*Cooling - T1 35°C	RT	38.2	39.8	41.4	42.9
		kW	134.4	140.0	145.6	151.2
		Btu/h	458,600	477,700	496,800	515,900
	**Cooling - T3 46°C	RT	36.0	36.4	37.8	38.9
		kW	126.6	128.1	133.2	136.8
		Btu/h	432,000	437,100	454,500	466,800
Heating	RT	42.8	44.6	46.5	48.3	
	kW	150.8	156.9	163.6	169.9	
	Btu/h	514,700	535,400	558,300	579,800	
Input (Rated)	*Cooling - T1 35°C	kW	30.70	31.47	32.32	34.10
	**Cooling - T3 46°C	kW	39.33	40.35	41.46	43.32
	Heating	kW	34.90	35.51	38.55	40.73
COP	*Cooling - T1 35°C	kW/kW	4.38	4.45	4.50	4.43
	**Cooling - T3 46°C	kW/kW	3.22	3.18	3.21	3.16
	Heating	kW/kW	4.32	4.42	4.24	4.17
Power Factor	Rated	-	0.93	0.93	0.93	0.93
Casing	Color		Warm Gray / Dawn Gray	Warm Gray / Dawn Gray	Warm Gray / Dawn Gray	Warm Gray / Dawn Gray
Heat Exchanger			Wide Louver Plus	Wide Louver Plus	Wide Louver Plus	Wide Louver Plus
Compressor	Type		Hermetically Sealed Scroll	Hermetically Sealed Scroll	Hermetically Sealed Scroll	Hermetically Sealed Scroll
	Piston Displacement	cm ³ /rev	62.1 x 4	(62.1 x 4) + (43.8 x 1)	62.1 x 5	62.1 x 5
	Number of Revolution	rev/min	3,600 x 4	3,600 x 5	3,600 x 5	3,600 x 5
	Motor Output x Number	W x No.	5,300 x 4	(5,300 x 4) + (4,200 x 1)	5,300 x 5	5,300 x 5
	Starting Method		Direct On Line	Direct On Line	Direct On Line	Direct On Line
	Oil Type		FVC68D (PVE)	FVC68D (PVE)	FVC68D (PVE)	FVC68D (PVE)
Fan	Type		Propeller fan	Propeller fan	Propeller fan	Propeller fan
	Motor Output x Number	W	900 x 6	900 x 6	900 x 6	900 x 6
	Air Flow Rate (High)	m ³ /min	320 x 3	320 x 3	320 x 3	320 x 3
		ft ³ /min	11,301 x 3	11,301 x 3	11,301 x 3	11,301 x 3
	Drive		DC INVERTER	DC INVERTER	DC INVERTER	DC INVERTER
Pipe Connctions	Discharge	Side / Top	TOP	TOP	TOP	TOP
	Liquid Pipe	mm (inch)	19.05 (3/4)	19.05 (3/4)	19.05 (3/4)	19.05 (3/4)
	Gas Pipe	mm (inch)	41.3 (1-5/8)	41.3 (1-5/8)	41.3 (1-5/8)	41.3 (1-5/8)
Dimensions (W x H x D)		mm	(1,240 x 1,690 x 760) x 3	(1,240 x 1,690 x 760) x 3	(1,240 x 1,690 x 760) x 3	(1,240 x 1,690 x 760) x 3
		inch	(48-13/16 x 66-17/32 x 29-29/32) x 3	(48-13/16 x 66-17/32 x 29-29/32) x 3	(48-13/16 x 66-17/32 x 29-29/32) x 3	(48-13/16 x 66-17/32 x 29-29/32) x 3
Net Weight		kg	(281 x 1) + (221 x 2)	(281 x 1) + (261 x 1) + (221 x 1)	(281 x 2) + (221 x 1)	(281 x 2) + (221 x 1)
		lbs	(619 x 1) + (487 x 2)	(619 x 1) + (575 x 1) + (487 x 1)	(619 x 2) + (487 x 1)	(619 x 2) + (487 x 1)
Sound Pressure Level	Cooling	dB(A)	65.5	65.7	65.8	66.2
	Heating	dB(A)	67.3	67.4	67.5	68.4
Sound Power Level	Cooling	dB(A)	88.5	88.8	89.4	89.8
	Heating	dB(A)	90.0	90.3	90.6	91.0
Communication Cable		No. x mm ² (VCTF-SB)	2C x 1.0 - 1.5	2C x 1.0 - 1.5	2C x 1.0 - 1.5	2C x 1.0 - 1.5
Refrigerant	Refrigerant Name		R410A	R410A	R410A	R410A
	Precharged Amount	kg	40.0	39.0	41.0	41.0
		lbs	88.3	86.1	90.5	90.5
	Control		Electronic Expansion Valve	Electronic Expansion Valve	Electronic Expansion Valve	Electronic Expansion Valve
Power Supply		∅, V, Hz	3, 380 - 415, 50	3, 380 - 415, 50	3, 380 - 415, 50	3, 380 - 415, 50
			3, 400, 60	3, 400, 60	3, 400, 60	3, 400, 60
Number of Maximum Connectable Indoor Units			64	64	64	64

MULTI V 5

TROPICAL MODEL

HIGH EFFICIENCY

ARUN560LEH5 / ARUN580LEH5 / ARUN600LEH5



HP		56	58	60	
Model Name	Combination Unit	ARUN560LEH5	ARUN580LEH5	ARUN600LEH5	
	Independent Unit	ARUN200LEH5 ARUN200LEH5 ARUN160LEH5	ARUN200LEH5 ARUN200LEH5 ARUN180LEH5	ARUN200LEH5 ARUN200LEH5 ARUN200LEH5	
		3	3	3	
Capacity (Rated)	*Cooling - T1 35°C	RT	44.5	46.1	47.7
		kW	156.8	162.4	168.0
		Btu/h	535,000	554,100	573,200
	**Cooling - T3 46°C	RT	39.3	40.7	41.7
		kW	138.3	143.4	147.0
		Btu/h	471,900	489,300	501,600
Heating	RT	50.0	51.9	53.7	
	kW	176.0	182.7	189.0	
	Btu/h	600,500	623,400	644,900	
Input (Rated)	*Cooling - T1 35°C	kW	34.87	35.72	37.50
	**Cooling - T3 46°C	kW	44.34	45.45	47.31
	Heating	kW	41.34	44.38	46.56
COP	*Cooling - T1 35°C	kW/kW	4.50	4.55	4.48
	**Cooling - T3 46°C	kW/kW	3.12	3.16	3.11
	Heating	kW/kW	4.26	4.12	4.06
Power Factor	Rated	-	0.93	0.93	
Casing	Color	Warm Gray / Dawn Gray	Warm Gray / Dawn Gray	Warm Gray / Dawn Gray	
Heat Exchanger		Wide Louver Plus	Wide Louver Plus	Wide Louver Plus	
Compressor	Type	Hermetically Sealed Scroll	Hermetically Sealed Scroll	Hermetically Sealed Scroll	
	Piston Displacement	cm ³ /rev	(62.1 x 5) + (43.8 x 1)	62.1 x 6	62.1 x 6
	Number of Revolution	rev/min	3,600 x 6	3,600 x 6	3,600 x 6
	Motor Output x Number	W x No.	(5,300 x 5) + (4,200 x 1)	5,300 x 6	5,300 x 6
	Starting Method		Direct On Line	Direct On Line	Direct On Line
	Oil Type		FVC68D (PVE)	FVC68D (PVE)	FVC68D (PVE)
Fan	Type	Propeller fan	Propeller fan	Propeller fan	
	Motor Output x Number	W	900 x 6	900 x 6	900 x 6
	Air Flow Rate (High)	m ³ /min	320 x 3	320 x 3	320 x 3
		ft ³ /min	11,301 x 3	11,301 x 3	11,301 x 3
Drive		DC INVERTER	DC INVERTER	DC INVERTER	
Pipe Connctions	Discharge	Side / Top	TOP	TOP	
	Liquid Pipe	mm (inch)	19.05 (3/4)	19.05 (3/4)	19.05 (3/4)
	Gas Pipe	mm (inch)	41.3 (1-5/8)	41.3 (1-5/8)	41.3 (1-5/8)
Dimensions (W x H x D)	mm	(1,240 x 1,690 x 760) x 3	(1,240 x 1,690 x 760) x 3	(1,240 x 1,690 x 760) x 3	
	inch	(48-13/16 x 66-17/32 x 29-29/32) x 3	(48-13/16 x 66-17/32 x 29-29/32) x 3	(48-13/16 x 66-17/32 x 29-29/32) x 3	
Net Weight	kg	(281 x 2) + (261 x 1)	281 x 3	281 x 3	
	lbs	(619 x 2) + (575 x 1)	619 x 3	619 x 3	
Sound Pressure Level	Cooling	dB(A)	66.3	66.5	66.8
	Heating	dB(A)	68.5	68.6	69.3
Sound Power Level	Cooling	dB(A)	90.0	90.5	90.8
	Heating	dB(A)	91.2	91.5	91.8
Communication Cable	No. x mm ² (VCTF-SB)	2C x 1.0 - 1.5	2C x 1.0 - 1.5	2C x 1.0 - 1.5	
Refrigerant	Refrigerant Name		R410A	R410A	R410A
	Precharged Amount	kg	40.0	42.0	42.0
		lbs	88.3	92.7	92.7
Control		Electronic Expansion Valve	Electronic Expansion Valve	Electronic Expansion Valve	
Power Supply	Ø, V, Hz		3, 380 - 415, 50	3, 380 - 415, 50	3, 380 - 415, 50
			3, 400, 60	3, 400, 60	3, 400, 60
Number of Maximum Connectable Indoor Units			64	64	64

NOTE

1. Capacities are based on the following conditions (ISO 15042)

- Cooling Temperature :
 - *Cooling (T1) : Indoor Temperature 27°C(80.6°F) DB/19°C(66.2°F) WB
Outdoor Temperature 35°C(95°F) DB/24°C(75.2°F)
 - **Cooling (T3) : Indoor Temperature 29°C(84.2°F) DB/19°C(66.2°F) WB
Outdoor Temperature 46°C(114.8°F) DB/24°C(75.2°F) WB
- Heating Temperature :
 - Indoor 20°C(68°F) DB / 15°C(59°F) WB
 - Outdoor 7°C(44.6°F) DB / 6°C(42.8°F) WB
- Piping Length : Interconnected Pipe Length = 7.5m
- Height difference between outdoor unit and indoor unit : 0m

2. The Maximum combination ratio is 130%.

3. Wiring cable size must comply with the applicable local and national codes. And "Electric characteristics" chapter should be considered for electrical work and design. Especially the power cable and circuit breaker should be selected in accordance with that.

4. Sound Level Values are measured at Anechoic chamber. Therefore, these values can be increased owing to ambient conditions during operation.

5. Power factor could vary less than ±1% according to the operating conditions.

6. Due to our policy of innovation some specifications may be changed without notification.

MULTI V 5

TROPICAL MODEL

STANDARD

ARUN080LTH5 / ARUN100LTH5 / ARUN120LTH5 / ARUN140LTH5



HP			8	10	12	14	
Model Name	Combination Unit		ARUN080LTH5	ARUN100LTH5	ARUN120LTH5	ARUN140LTH5	
	Independent Unit		ARUN080LTH5	ARUN100LTH5	ARUN120LTH5	ARUN140LTH5	
Capacity	*Cooling (Rated)	RT	6.4	8.0	9.5	11.1	
		kW	22.4	28.0	33.6	39.2	
		Btu/h	76,400	95,500	114,600	133,800	
	**Cooling (Rated)	RT	5.6	7.1	8.9	10.5	
		kW	19.8	25.0	31.2	36.8	
		Btu/h	67,600	85,300	106,500	125,600	
	Heating (Rated)	RT	7.2	8.6	10.7	12.5	
		kW	25.2	30.3	37.8	43.9	
Btu/h		86,000	103,400	129,000	149,900		
Input	*Cooling (Rated)	kW	5.00	7.00	8.00	9.30	
	**Cooling (Rated)	kW	6.37	8.33	9.54	11.20	
	Heating (Rated)	kW	5.80	7.30	8.06	9.69	
COP	*Cooling (Rated)	kW	4.48	4.00	4.20	4.22	
	**Cooling (Rated)	kW	3.11	3.00	3.27	3.29	
	Heating (Rated)	kW	4.34	4.15	4.69	4.53	
Power Factor	Rated	-	0.93	0.93	0.93	0.93	
Casing	Color		Warm Gray / Dawn Gray	Warm Gray / Dawn Gray	Warm Gray / Dawn Gray	Warm Gray / Dawn Gray	
Heat Exchanger			Wide Louver Plus	Wide Louver Plus	Wide Louver Plus	Wide Louver Plus	
Compressor	Type		Hermetically Sealed Scroll	Hermetically Sealed Scroll	Hermetically Sealed Scroll	Hermetically Sealed Scroll	
	Piston Displacement	cm ³ /rev	62.1	62.1	62.1	62.1	
	Number of Revolution	rev/min	3,600	3,600	3,600	3,600	
	Motor Output x Number	W x No.	5,300 x 1	5,300 x 1	5,300 x 1	5,300 x 1	
	Starting Method		Direct On Line	Direct On Line	Direct On Line	Direct On Line	
	Oil Type		FVC68D (PVE)	FVC68D (PVE)	FVC68D (PVE)	FVC68D (PVE)	
Fan	Type		Propeller fan	Propeller fan	Propeller fan	Propeller fan	
	Motor Output x Number	W	1,200 x 1	1,200 x 1	1,200 x 1	900 x 2	
	Air Flow Rate(High)	m ³ /min ft ³ /min	240 x 1 8,476 x 1	240 x 1 8,476 x 1	240 x 1 8,476 x 1	320 x 1 11,301 x 1	
	External Static Pressure (Max, Pa)		80	80	80	80	
	Drive		DC INVERTER	DC INVERTER	DC INVERTER	DC INVERTER	
	Discharge	Side / Top	TOP	TOP	TOP	TOP	
Pipe Connctions	Liquid Pipe	mm (inch)	9.52 (3/8)	9.52 (3/8)	12.7 (1/2)	12.7 (1/2)	
	Gas Pipe	mm (inch)	19.05 (3/4)	22.2 (7/8)	28.58 (1-1/8)	28.58 (1-1/8)	
Dimensions (W x H x D)	mm		(930 x 1,690 x 760) x 1	(930 x 1,690 x 760) x 1	(930 x 1,690 x 760) x 1	(1,240 x 1,690 x 760) x 1	
	inch		(36-5/8 x 66-17/32 x 29-29/32) x 1	(36-5/8 x 66-17/32 x 29-29/32) x 1	(36-5/8 x 66-17/32 x 29-29/32) x 1	(48-13/16 x 66-17/32 x 29-29/32) x 1	
Net Weight	kg		173 x 1	171 x 1	200 x 1	221 x 1	
	lbs		381 x 1	377 x 1	441 x 1	487 x 1	
Sound Pressure Level	Cooling	dB(A)	58.0	58.5	59.0	60.0	
	Heating	dB(A)	60.0	60.5	60.0	61.0	
Sound Power Level	Cooling	dB(A)	78.0	79.0	79.0	82.0	
	Heating	dB(A)	80.0	80.0	80.0	84.0	
Communication Cable	No. x mm ² (VCTF-SB)		2C x 1.0 - 1.5	2C x 1.0 - 1.5	2C x 1.0 - 1.5	2C x 1.0 - 1.5	
Refrigerant	Refrigerant name		R410A	R410A	R410A	R410A	
	Precharged Amount in factory		kg lbs	4.7 10.4	4.7 10.4	10.0 22.0	13.0 28.7
	Control		Electronic Expansion Valve	Electronic Expansion Valve	Electronic Expansion Valve	Electronic Expansion Valve	
Power Supply	Ø, V, Hz		3, 380 - 415, 50	3, 380 - 415, 50	3, 380 - 415, 50	3, 380 - 415, 50	
			3, 400, 60	3, 400, 60	3, 400, 60	3, 400, 60	
Number of Maximum Connectable Indoor Units			13	16	20	23	

TROPICAL MODEL

STANDARD

ARUN160LTH5 / ARUN180LTH5 / ARUN200LTH5 / ARUN220LTH5



HP			16	18	20	22	
Model Name	Combination Unit		ARUN160LTH5	ARUN180LTH5	ARUN200LTH5	ARUN220LTH5	
	Independent Unit		ARUN160LTH5	ARUN180LTH5	ARUN200LTH5	ARUN220LTH5	
Capacity	*Cooling (Rated)	RT	1	1	1	1	
		kW	12.7	14.3	15.9	17.5	
		Btu/h	44.8	50.4	56.0	61.6	
	**Cooling (Rated)	RT	11.4	12.4	13.6	14.1	
		kW	40.3	43.6	48.0	49.6	
		Btu/h	137,500	148,800	163,800	169,100	
	Heating (Rated)	RT	14.2	16.1	17.9	19.7	
		kW	50.0	56.7	63.0	69.3	
Btu/h		170,600	193,500	215,000	236,500		
Input	*Cooling (Rated)	kW	10.80	11.20	13.00	14.84	
	**Cooling (Rated)	kW	13.15	14.39	15.77	16.72	
	Heating (Rated)	kW	11.36	11.98	15.52	17.54	
COP	*Cooling (Rated)	kW	4.15	4.50	4.31	4.15	
	**Cooling (Rated)	kW	3.06	3.03	3.04	2.96	
	Heating (Rated)	kW	4.40	4.73	4.06	3.95	
Power Factor	Rated	-	0.93	0.93	0.93	0.93	
Casing	Color		Warm Gray / Dawn Gray	Warm Gray / Dawn Gray	Warm Gray / Dawn Gray	Warm Gray / Dawn Gray	
Heat Exchanger			Wide Louver Plus	Wide Louver Plus	Wide Louver Plus	Wide Louver Plus	
Compressor	Type		Hermetically Sealed Scroll	Hermetically Sealed Scroll	Hermetically Sealed Scroll	Hermetically Sealed Scroll	
	Piston Displacement	cm ³ /rev	62.1	62.1 x 1 + 43.8 x 1	62.1 x 2	62.1 x 2	
	Number of Revolution	rev/min	3,600	3,600 x 2	3,600 x 2	3,600 x 2	
	Motor Output x Number	W x No.	5,300 x 1	5,300 x 1 + 4,200 x 1	5,300 x 2	5,300 x 2	
	Starting Method		Direct On Line	Direct On Line	Direct On Line	Direct On Line	
	Oil Type		FVC68D (PVE)	FVC68D (PVE)	FVC68D (PVE)	FVC68D (PVE)	
Fan	Type		Propeller fan	Propeller fan	Propeller fan	Propeller fan	
	Motor Output x Number	W	900 x 2	900 x 2	900 x 2	900 x 2	
	Air Flow Rate(High)	m ³ /min ft ³ /min	320 x 1 11,301 x 1	320 x 1 11,301 x 1	320 x 1 11,301 x 1	320 x 1 11,301 x 1	
	External Static Pressure (Max, Pa)		80	80	80	80	
	Drive		DC INVERTER	DC INVERTER	DC INVERTER	DC INVERTER	
	Discharge	Side / Top	TOP	TOP	TOP	TOP	
Pipe Connctions	Liquid Pipe	mm (inch)	12.7 (1/2)	15.88 (5/8)	15.88 (5/8)	15.88 (5/8)	
	Gas Pipe	mm (inch)	28.58 (1-1/8)	28.58 (1-1/8)	28.58 (1-1/8)	28.58 (1-1/8)	
Dimensions (W x H x D)	mm		(1,240 x 1,690 x 760) x 1	(1,240 x 1,690 x 760) x 1	(1,240 x 1,690 x 760) x 1	(1,240 x 1,690 x 760) x 1	
	inch		(48-13/16 x 66-17/32 x 29-29/32) x 1	(48-13/16 x 66-17/32 x 29-29/32) x 1	(48-13/16 x 66-17/32 x 29-29/32) x 1	(48-13/16 x 66-17/32 x 29-29/32) x 1	
Net Weight	kg		221 x 1	261 x 1	281 x 1	281 x 1	
	lbs		487 x 1	575 x 1	619 x 1	619 x 1	
Sound Pressure Level	Cooling	dB(A)	60.5	61.0	62.0	64.5	
	Heating	dB(A)	61.5	62.0	64.5	65.5	
Sound Power Level	Cooling	dB(A)	83.0	85.0	86.0	86.0	
	Heating	dB(A)	85.0	86.0	87.0	88.0	
Communication Cable	No. x mm ² (VCTF-SB)		2C x 1.0 - 1.5	2C x 1.0 - 1.5	2C x 1.0 - 1.5	2C x 1.0 - 1.5	
Refrigerant	Refrigerant name		R410A	R410A	R410A	R410A	
	Precharged Amount in factory		kg lbs	13.0 28.7	13.0 28.7	14.0 30.9	14.0 30.9
	Control		Electronic Expansion Valve	Electronic Expansion Valve	Electronic Expansion Valve	Electronic Expansion Valve	
Power Supply	Ø, V, Hz		3, 380 - 415, 50	3, 380 - 415, 50	3, 380 - 415, 50	3, 380 - 415, 50	
			3, 400, 60	3, 400, 60	3, 400, 60	3, 400, 60	
Number of Maximum Connectable Indoor Units			26	29	32	35	

MULTI V 5

TROPICAL MODEL

STANDARD

ARUN240LTH5 / ARUN260LTH5
ARUN280LTH5 / ARUN300LTH5



HP			24	26	28	30
Model Name	Combination Unit		ARUN240LTH5	ARUN260LTH5	ARUN280LTH5	ARUN300LTH5
	Independent Unit		ARUN120LTH5 ARUN120LTH5	ARUN140LTH5 ARUN120LTH5	ARUN160LTH5 ARUN120LTH5	ARUN160LTH5 ARUN140LTH5
			2	2	2	2
Capacity	*Cooling (Rated)	RT	19.1	20.7	22.3	23.9
		kW	67.2	72.8	78.4	84.0
	Btu/h	229,300	248,400	267,500	286,600	
	**Cooling (Rated)	RT	17.7	19.3	20.3	21.9
		kW	62.4	68.0	71.5	77.1
	Btu/h	212,900	232,000	244,000	263,100	
Heating (Rated)	RT	21.5	23.2	24.9	26.7	
	kW	75.6	81.7	87.8	93.9	
Btu/h	257,900	278,800	299,600	320,500		
Input	*Cooling (Rated)	kW	16.00	17.30	18.80	20.10
	**Cooling (Rated)	kW	19.08	20.74	22.69	24.35
	Heating (Rated)	kW	16.12	17.75	19.42	21.05
COP	*Cooling (Rated)	kW	4.20	4.21	4.17	4.18
	**Cooling (Rated)	kW	3.27	3.28	3.15	3.17
	Heating (Rated)	kW	4.69	4.60	4.52	4.46
Power Factor	Rated	-	0.93	0.93	0.93	0.93
Casing	Color		Warm Gray / Dawn Gray	Warm Gray / Dawn Gray	Warm Gray / Dawn Gray	Warm Gray / Dawn Gray
Heat Exchanger			Wide Louver Plus	Wide Louver Plus	Wide Louver Plus	Wide Louver Plus
Compressor	Type		Hermetically Sealed Scroll	Hermetically Sealed Scroll	Hermetically Sealed Scroll	Hermetically Sealed Scroll
	Piston Displacement	cm ³ /rev	62.1 x 2	62.1 x 2	62.1 x 2	62.1 x 2
	Number of Revolution	rev/min	3,600 x 2	3,600 x 2	3,600 x 2	3,600 x 2
	Motor Output x Number	W x No.	5,300 x 2	5,300 x 2	5,300 x 2	5,300 x 2
	Starting Method		Direct On Line	Direct On Line	Direct On Line	Direct On Line
	Oil Type		FVC68D (PVE)	FVC68D (PVE)	FVC68D (PVE)	FVC68D (PVE)
Fan	Type		Propeller fan	Propeller fan	Propeller fan	Propeller fan
	Motor Output x Number	W	1,200 x 2	(900 x 2) + (1,200 x 1)	(900 x 2) + (1,200 x 1)	900 x 4
	Air Flow Rate(High)	m ³ /min ft ³ /min	240 x 2 8,476 x 2	(320 x 1) + (240 x 1) (11,301 x 1) + (8,476 x 1)	(320 x 1) + (240 x 1) (11,301 x 1) + (8,476 x 1)	320 x 2 11,301 x 2
	External Static Pressure (Max, Pa)		80	80	80	80
	Drive		DC INVERTER	DC INVERTER	DC INVERTER	DC INVERTER
Discharge	Side / Top	TOP	TOP	TOP	TOP	
Pipe Connctions	Liquid Pipe	mm (inch)	15.88 (5/8)	19.05 (3/4)	19.05 (3/4)	19.05 (3/4)
	Gas Pipe	mm (inch)	34.9 (1-3/8)	34.9 (1-3/8)	34.9 (1-3/8)	34.9 (1-3/8)
Dimensions (W x H x D)	mm		(930 x 1,690 x 760) x 2	(1,240 x 1,690 x 760) x 1 + (930 x 1,690 x 760) x 1	(1,240 x 1,690 x 760) x 1 + (930 x 1,690 x 760) x 1	(1,240 x 1,690 x 760) x 2
	inch		(36-5/8 x 66-17/32 x 29-29/32) x 2	(48-13/16 x 66-17/32 x 29-29/32) x 1 + (36-5/8 x 66-17/32 x 29-29/32) x 1	(48-13/16 x 66-17/32 x 29-29/32) x 1 + (36-5/8 x 66-17/32 x 29-29/32) x 1	(48-13/16 x 66-17/32 x 29-29/32) x 2
Net Weight	kg		200 x 2	(221 x 1) + (200 x 1)	(221 x 1) + (200 x 1)	221 x 2
	lbs		441 x 2	(487 x 1) + (441 x 1)	(487 x 1) + (441 x 1)	487 x 2
Sound Pressure Level	Cooling	dB(A)	62.0	62.5	62.8	63.3
	Heating	dB(A)	63.0	63.5	63.8	64.3
Sound Power Level	Cooling	dB(A)	82.0	83.8	84.5	85.5
	Heating	dB(A)	83.0	85.5	86.2	87.5
Communication Cable	No. x mm ² (VCTF-SB)		2C x 1.0 - 1.5	2C x 1.0 - 1.5	2C x 1.0 - 1.5	2C x 1.0 - 1.5
Refrigerant	Refrigerant name		R410A	R410A	R410A	R410A
	Precharged Amount in factory	kg lbs	10.0 + 10.0 22.0 + 22.0	13.0 + 10.0 28.7 + 22.0	13.0 + 10.0 28.7 + 22.0	13.0 + 13.0 28.7 + 28.7
	Control		Electronic Expansion Valve	Electronic Expansion Valve	Electronic Expansion Valve	Electronic Expansion Valve
	Power Supply	∅, V, Hz	3, 380 - 415, 50 3, 400, 60	3, 380 - 415, 50 3, 400, 60	3, 380 - 415, 50 3, 400, 60	3, 380 - 415, 50 3, 400, 60
Number of Maximum Connectable Indoor Units		39	42	45	49	

TROPICAL MODEL

STANDARD

ARUN320LTH5 / ARUN340LTH5 / ARUN360LTH5



HP			32	34	36
Model Name	Combination Unit		ARUN320LTH5	ARUN340LTH5	ARUN360LTH5
	Independent Unit		ARUN160LTH5 ARUN160LTH5	ARUN180LTH5 ARUN160LTH5	ARUN200LTH5 ARUN160LTH5
			2	2	2
Capacity	*Cooling (Rated)	RT	25.4	27.0	28.6
		kW	89.6	95.2	100.8
	Btu/h	305,700	324,800	343,900	
	**Cooling (Rated)	RT	22.9	23.8	25.1
		kW	80.6	83.9	88.3
	Btu/h	275,000	286,300	301,300	
Heating (Rated)	RT	28.4	30.3	32.1	
	kW	100.0	106.7	113.0	
Btu/h	341,200	364,100	385,600		
Input	*Cooling (Rated)	kW	21.60	22.00	23.80
	**Cooling (Rated)	kW	26.30	27.54	28.92
	Heating (Rated)	kW	22.72	23.34	26.88
COP	*Cooling (Rated)	kW	4.15	4.33	4.24
	**Cooling (Rated)	kW	3.06	3.05	3.05
	Heating (Rated)	kW	4.40	4.57	4.20
Power Factor	Rated	-	0.93	0.93	0.93
Casing	Color		Warm Gray / Dawn Gray	Warm Gray / Dawn Gray	Warm Gray / Dawn Gray
Heat Exchanger			Wide Louver Plus	Wide Louver Plus	Wide Louver Plus
Compressor	Type		Hermetically Sealed Scroll	Hermetically Sealed Scroll	Hermetically Sealed Scroll
	Piston Displacement	cm ³ /rev	62.1 x 2	(62.1 x 2) + (43.8 x 1)	62.1 x 3
	Number of Revolution	rev/min	3,600 x 2	3,600 x 3	3,600 x 3
	Motor Output x Number	W x No.	5,300 x 2	(5,300 x 2) + (4,200 x 1)	5,300 x 3
	Starting Method		Direct On Line	Direct On Line	Direct On Line
	Oil Type		FVC68D (PVE)	FVC68D (PVE)	FVC68D (PVE)
Fan	Type		Propeller fan	Propeller fan	Propeller fan
	Motor Output x Number	W	900 x 4	900 x 4	900 x 4
	Air Flow Rate(High)	m ³ /min ft ³ /min	320 x 2 11,301 x 2	320 x 2 11,301 x 2	320 x 2 11,301 x 2
	External Static Pressure (Max, Pa)		80	80	80
	Drive		DC INVERTER	DC INVERTER	DC INVERTER
Discharge	Side / Top	TOP	TOP	TOP	
Pipe Connctions	Liquid Pipe	mm (inch)	19.05 (3/4)	19.05 (3/4)	19.05 (3/4)
	Gas Pipe	mm (inch)	34.9 (1-3/8)	34.9 (1-3/8)	41.3 (1-5/8)
Dimensions (W x H x D)	mm		(1,240 x 1,690 x 760) x 2	(1,240 x 1,690 x 760) x 2	(1,240 x 1,690 x 760) x 2
	inch		(48-13/16 x 66-17/32 x 29-29/32) x 2	(48-13/16 x 66-17/32 x 29-29/32) x 2	(48-13/16 x 66-17/32 x 29-29/32) x 2
Net Weight	kg		221 x 2	(261 x 1) + (221 x 1)	(281 x 1) + (221 x 1)
	lbs		487 x 2	(575 x 1) + (487 x 1)	(619 x 1) + (487 x 1)
Sound Pressure Level	Cooling	dB(A)	63.5	63.8	64.3
	Heating	dB(A)	64.5	64.8	66.3
Sound Power Level	Cooling	dB(A)	86.0	87.1	87.8
	Heating	dB(A)	88.0	88.5	89.1
Communication Cable	No. x mm ² (VCTF-SB)		2C x 1.0 - 1.5	2C x 1.0 - 1.5	2C x 1.0 - 1.5
Refrigerant	Refrigerant name		R410A	R410A	R410A
	Precharged Amount in factory	kg lbs	13.0 + 13.0 28.7 + 28.7	13.0 + 13.0 28.7 + 28.7	14.0 + 13.0 30.9 + 28.7
	Control		Electronic Expansion Valve	Electronic Expansion Valve	Electronic Expansion Valve
Power Supply	∅, V, Hz	3, 380 - 415, 50 3, 400, 60	3, 380 - 415, 50 3, 400, 60	3, 380 - 415, 50 3, 400, 60	
Number of Maximum Connectable Indoor Units		52	55	58	

MULTI V 5

TROPICAL MODEL

STANDARD

ARUN380LTH5 / ARUN400LTH5 / ARUN420LTH5



HP			38	40	42
Model Name	Combination Unit		ARUN380LTH5	ARUN400LTH5	ARUN420LTH5
	Independent Unit		ARUN220LTH5 ARUN160LTH5	ARUN200LTH5 ARUN200LTH5	ARUN220LTH5 ARUN200LTH5
Capacity	*Cooling (Rated)	RT	30.2	31.8	33.4
		kW	106.4	112.0	117.6
		Btu/h	363,000	382,100	401,300
	**Cooling (Rated)	RT	25.5	27.3	27.7
		kW	89.9	96.0	97.6
		Btu/h	306,600	327,600	332,900
	Heating (Rated)	RT	33.9	35.8	37.6
		kW	119.3	126.0	132.3
		Btu/h	407,100	429,900	451,400
	Input	*Cooling (Rated) kW	25.64	26.00	27.84
**Cooling (Rated) kW		29.87	31.54	32.49	
Heating (Rated) kW		28.90	31.04	33.06	
COP	*Cooling (Rated) kW	4.15	4.31	4.22	
	**Cooling (Rated) kW	3.01	3.04	3.00	
	Heating (Rated) kW	4.13	4.06	4.00	
Power Factor	Rated	-	0.93	0.93	
Casing	Color		Warm Gray / Dawn Gray	Warm Gray / Dawn Gray	Warm Gray / Dawn Gray
Heat Exchanger	Type		Wide Louver Plus	Wide Louver Plus	Wide Louver Plus
	Type		Hermetically Sealed Scroll	Hermetically Sealed Scroll	Hermetically Sealed Scroll
Compressor	Piston Displacement	cm ³ /rev	62.1 x 3	62.1 x 4	62.1 x 4
	Number of Revolution	rev/min	3,600 x 3	3,600 x 4	3,600 x 4
	Motor Output x Number	W x No.	5,300 x 3	5,300 x 4	5,300 x 4
	Starting Method		Direct On Line	Direct On Line	Direct On Line
	Oil Type		FVC68D (PVE)	FVC68D (PVE)	FVC68D (PVE)
	Type		Propeller fan	Propeller fan	Propeller fan
Fan	Motor Output x Number	W	900 x 4	900 x 4	900 x 4
	Air Flow Rate(High)	m ³ /min ft ³ /min	320 x 2 11,301 x 2	320 x 2 11,301 x 2	320 x 2 11,301 x 2
	External Static Pressure (Max, Pa)		80	80	80
	Drive		DC INVERTER	DC INVERTER	DC INVERTER
	Discharge	Side / Top	TOP	TOP	TOP
Pipe Connctions	Liquid Pipe	mm (inch)	19.05 (3/4)	19.05 (3/4)	19.05 (3/4)
	Gas Pipe	mm (inch)	41.3 (1-5/8)	41.3 (1-5/8)	41.3 (1-5/8)
Dimensions (W x H x D)	mm		(1,240 x1,690 x 760) x 2	(1,240 x1,690 x 760) x 2	(1,240 x1,690 x 760) x 2
	inch		(48-13/16 x 66-17/32 x 29-29/32) x 2	(48-13/16 x 66-17/32 x 29-29/32) x 2	(48-13/16 x 66-17/32 x 29-29/32) x 2
Net Weight	kg		(281 x 1) + (221 x 1)	281 x 2	281 x 2
	lbs		(619 x 1) + (487 x 1)	619 x 2	619 x 2
Sound Pressure Level	Cooling	dB(A)	66.0	65.0	66.4
	Heating	dB(A)	67.0	67.5	68.0
Sound Power Level	Cooling	dB(A)	87.8	89.0	89.0
	Heating	dB(A)	89.8	90.0	90.5
Communication Cable	No. x mm ² (VCTF-SB)		2C x 1.0 - 1.5	2C x 1.0 - 1.5	2C x 1.0 - 1.5
Refrigerant	Refrigerant name		R410A	R410A	R410A
	Precharged Amount in factory	kg lbs	14.0 + 13.0 30.9 + 28.7	14.0 + 14.0 30.9 + 30.9	14.0 + 14.0 30.9 + 30.9
	Control		Electronic Expansion Valve	Electronic Expansion Valve	Electronic Expansion Valve
Power Supply	Ø, V, Hz		3, 380 - 415, 50	3, 380 - 415, 50	3, 380 - 415, 50
Number of Maximum Connectable Indoor Units			61	64	64

TROPICAL MODEL

STANDARD

ARUN440LTH5 / ARUN460LTH5 / ARUN480LTH5



HP			44	46	48
Model Name	Combination Unit		ARUN440LTH5	ARUN460LTH5	ARUN480LTH5
	Independent Unit		ARUN220LTH5 ARUN220LTH5	ARUN160LTH5 ARUN160LTH5 ARUN140LTH5	ARUN160LTH5 ARUN160LTH5 ARUN160LTH5
Capacity	*Cooling (Rated)	RT	35.0	36.6	38.2
		kW	123.2	128.8	134.4
		Btu/h	420,400	439,500	458,600
	**Cooling (Rated)	RT	28.2	33.3	34.3
		kW	99.2	117.4	120.9
		Btu/h	338,200	400,600	412,500
	Heating (Rated)	RT	39.4	40.9	42.6
		kW	138.6	143.9	150.0
		Btu/h	472,900	491,000	511,800
	Input	*Cooling (Rated) kW	29.68	30.90	32.40
**Cooling (Rated) kW		33.44	37.50	39.45	
Heating (Rated) kW		35.08	32.41	34.08	
COP	*Cooling (Rated) kW	4.15	4.17	4.15	
	**Cooling (Rated) kW	2.97	3.13	3.06	
	Heating (Rated) kW	3.95	4.44	4.40	
Power Factor	Rated	-	0.93	0.93	
Casing	Color		Warm Gray / Dawn Gray	Warm Gray / Dawn Gray	Warm Gray / Dawn Gray
Heat Exchanger	Type		Wide Louver Plus	Wide Louver Plus	Wide Louver Plus
	Type		Hermetically Sealed Scroll	Hermetically Sealed Scroll	Hermetically Sealed Scroll
Compressor	Piston Displacement	cm ³ /rev	62.1 x 4	62.1 x 3	62.1 x 3
	Number of Revolution	rev/min	3,600 x 4	3,600 x 3	3,600 x 3
	Motor Output x Number	W x No.	5,300 x 4	5,300 x 3	5,300 x 3
	Starting Method		Direct On Line	Direct On Line	Direct On Line
	Oil Type		FVC68D (PVE)	FVC68D (PVE)	FVC68D (PVE)
	Type		Propeller fan	Propeller fan	Propeller fan
Fan	Motor Output x Number	W	900 x 4	900 x 6	900 x 6
	Air Flow Rate(High)	m ³ /min ft ³ /min	320 x 2 1,1301 x 2	320 x 3 11,301 x 3	320 x 3 11,301 x 3
	External Static Pressure (Max, Pa)		80	80	80
	Drive		DC INVERTER	DC INVERTER	DC INVERTER
	Discharge	Side / Top	TOP	TOP	TOP
Pipe Connctions	Liquid Pipe	mm (inch)	19.05 (3/4)	19.05 (3/4)	19.05 (3/4)
	Gas Pipe	mm (inch)	41.3 (1-5/8)	41.3 (1-5/8)	41.3 (1-5/8)
Dimensions (W x H x D)	mm		(1,240 x1,690 x 760) x 2	(1,240 x1,690 x 760) x 3	(1,240 x1,690 x 760) x 3
	inch		(48-13/16 x 66-17/32 x 29-29/32) x 2	(48-13/16 x 66-17/32 x 29-29/32) x 3	(48-13/16 x 66-17/32 x 29-29/32) x 3
Net Weight	kg		281 x 2	221 x 3	221 x 3
	lbs		619 x 2	487 x 3	487 x 3
Sound Pressure Level	Cooling	dB(A)	67.5	65.1	65.3
	Heating	dB(A)	68.5	66.1	66.3
Sound Power Level	Cooling	dB(A)	89.0	87.5	87.8
	Heating	dB(A)	91.0	89.5	89.8
Communication Cable	No. x mm ² (VCTF-SB)		2C x 1.0 - 1.5	2C x 1.0 - 1.5	2C x 1.0 - 1.5
Refrigerant	Refrigerant name		R410A	R410A	R410A
	Precharged Amount in factory	kg lbs	14.0 + 14.0 30.9 + 30.9	13.0 + 13.0 + 13.0 28.7 + 28.7 + 28.7	13.0 + 13.0 + 13.0 28.7 + 28.7 + 28.7
	Control		Electronic Expansion Valve	Electronic Expansion Valve	Electronic Expansion Valve
Power Supply	Ø, V, Hz		3, 380 - 415, 50	3, 380 - 415, 50	3, 380 - 415, 50
Number of Maximum Connectable Indoor Units			64	64	64

MULTI V 5

TROPICAL MODEL

STANDARD

ARUN500LTH5 / ARUN520LTH5 / ARUN540LTH5



HP			50	52	54
Model Name	Combination Unit		ARUN500LTH5	ARUN520LTH5	ARUN540LTH5
	Independent Unit		ARUN180LTH5 ARUN160LTH5 ARUN160LTH5	ARUN200LTH5 ARUN160LTH5 ARUN160LTH5	ARUN220LTH5 ARUN160LTH5 ARUN160LTH5
Capacity	*Cooling (Rated)	RT	39.8	41.4	42.9
		kW	140.0	145.6	151.2
		Btu/h	477,700	496,800	515,900
	**Cooling (Rated)	RT	35.3	36.5	37.0
		kW	124.2	128.6	130.2
		Btu/h	423,800	438,800	444,200
Heating (Rated)	RT	44.5	46.3	48.1	
	kW	156.7	163.0	169.3	
	Btu/h	534,700	556,200	577,700	
Input	*Cooling (Rated)	kW	32.80	34.60	36.44
	**Cooling (Rated)	kW	40.69	42.07	43.02
	Heating (Rated)	kW	34.70	38.24	40.26
COP	*Cooling (Rated)	kW	4.27	4.21	4.15
	**Cooling (Rated)	kW	3.05	3.06	3.03
	Heating (Rated)	kW	4.52	4.26	4.21
Power Factor	Rated	-	0.93	0.93	
Casing	Color		Warm Gray / Dawn Gray	Warm Gray / Dawn Gray	Warm Gray / Dawn Gray
Heat Exchanger			Wide Louver Plus	Wide Louver Plus	Wide Louver Plus
Compressor	Type		Hermetically Sealed Scroll	Hermetically Sealed Scroll	Hermetically Sealed Scroll
	Piston Displacement	cm ³ /rev	(62.1 x 3) + (43.8 x 1)	62.1 x 4	62.1 x 4
	Number of Revolution	rev/min	3,600 x 4	3,600 x 4	3,600 x 4
	Motor Output x Number	W x No.	(5,300 x 3) + (4,200 x 1)	5,300 x 4	5,300 x 4
	Starting Method		Direct On Line	Direct On Line	Direct On Line
	Oil Type		FVC68D (PVE)	FVC68D (PVE)	FVC68D (PVE)
Fan	Type		Propeller fan	Propeller fan	Propeller fan
	Motor Output x Number	W	900 x 6	900 x 6	900 x 6
	Air Flow Rate(High)	m ³ /min ft ³ /min	320 x 3 11,301 x 3	320 x 3 11,301 x 3	320 x 3 11,301 x 3
	External Static Pressure (Max, Pa)		80	80	80
	Drive		DC INVERTER	DC INVERTER	DC INVERTER
	Discharge	Side / Top	TOP	TOP	TOP
Pipe Connections	Liquid Pipe	mm (inch)	19.05 (3/4)	19.05 (3/4)	19.05 (3/4)
	Gas Pipe	mm (inch)	41.3 (1-5/8)	41.3 (1-5/8)	41.3 (1-5/8)
Dimensions (W x H x D)	mm		(1,240 x1,690 x 760) x 3	(1,240 x1,690 x 760) x 3	(1,240 x1,690 x 760) x 3
	inch		(48-13/16 x 66-17/32 x 29-29/32) x 3	(48-13/16 x 66-17/32 x 29-29/32) x 3	(48-13/16 x 66-17/32 x 29-29/32) x 3
Net Weight	kg		(261 x 1) + (221 x 2)	(281 x 1) + (221 x 2)	(281 x 1) + (221 x 2)
	lbs		(575 x 1) + (487 x 2)	(619 x 1) + (487 x 2)	(619 x 1) + (487 x 2)
Sound Pressure Level	Cooling	dB(A)	65.4	65.8	67.0
	Heating	dB(A)	66.4	67.5	68.0
Sound Power Level	Cooling	dB(A)	88.5	89.0	89.0
	Heating	dB(A)	90.1	90.5	91.0
Communication Cable	No. x mm ² (VCTF-SB)		2C x 1.0 - 1.5	2C x 1.0 - 1.5	2C x 1.0 - 1.5
Refrigerant	Refrigerant name		R410A	R410A	R410A
	Precharged Amount in factory	kg lbs	13.0 + 13.0 + 13.0 28.7 + 28.7 + 28.7	14.0 + 13.0 + 13.0 30.9 + 28.7 + 28.7	14.0 + 13.0 + 13.0 30.9 + 28.7 + 28.7
	Control		Electronic Expansion Valve	Electronic Expansion Valve	Electronic Expansion Valve
Power Supply	Ø, V, Hz		3, 380 - 415, 50	3, 380 - 415, 50	3, 380 - 415, 50
Number of Maximum Connectable Indoor Units			3, 400, 60	3, 400, 60	3, 400, 60

TROPICAL MODEL

STANDARD

ARUN560LTH5 / ARUN580LTH5 / ARUN600LTH5



HP			56	58	60
Model Name	Combination Unit		ARUN560LTH5	ARUN580LTH5	ARUN600LTH5
	Independent Unit		ARUN200LTH5 ARUN200LTH5 ARUN160LTH5	ARUN220LTH5 ARUN200LTH5 ARUN160LTH5	ARUN220LTH5 ARUN200LTH5 ARUN160LTH5
Capacity	*Cooling (Rated)	RT	3	3	3
		kW	44.5	46.1	47.7
		Btu/h	156.8	162.4	168.0
	**Cooling (Rated)	RT	38.7	39.2	39.6
		kW	136.3	137.9	139.5
		Btu/h	465,100	470,500	476,000
Heating (Rated)	RT	50.0	51.8	53.6	
	kW	176.0	182.3	188.6	
	Btu/h	600,500	622,000	643,500	
Input	*Cooling (Rated)	kW	36.80	38.64	40.48
	**Cooling (Rated)	kW	44.69	45.64	46.59
	Heating (Rated)	kW	42.40	44.42	46.44
COP	*Cooling (Rated)	kW	4.26	4.20	4.15
	**Cooling (Rated)	kW	3.05	3.02	2.99
	Heating (Rated)	kW	4.15	4.10	4.06
Power Factor	Rated	-	0.93	0.93	
Casing	Color		Warm Gray / Dawn Gray	Warm Gray / Dawn Gray	Warm Gray / Dawn Gray
Heat Exchanger			Wide Louver Plus	Wide Louver Plus	Wide Louver Plus
Compressor	Type		Hermetically Sealed Scroll	Hermetically Sealed Scroll	Hermetically Sealed Scroll
	Piston Displacement	cm ³ /rev	62.1 x 5	62.1 x 5	62.1 x 5
	Number of Revolution	rev/min	3,600 x 5	3,600 x 5	3,600 x 5
	Motor Output x Number	W x No.	5,300 x 5	5,300 x 5	5,300 x 5
	Starting Method		Direct On Line	Direct On Line	Direct On Line
	Oil Type		FVC68D (PVE)	FVC68D (PVE)	FVC68D (PVE)
Fan	Type		Propeller fan	Propeller fan	Propeller fan
	Motor Output x Number	W	900 x 6	900 x 6	900 x 6
	Air Flow Rate(High)	m ³ /min ft ³ /min	320 x 3 11,301 x 3	320 x 3 11,301 x 3	320 x 3 11,301 x 3
	External Static Pressure (Max, Pa)		80	80	80
	Drive		DC INVERTER	DC INVERTER	DC INVERTER
	Discharge	Side / Top	TOP	TOP	TOP
Pipe Connections	Liquid Pipe	mm (inch)	19.05 (3/4)	19.05 (3/4)	19.05 (3/4)
	Gas Pipe	mm (inch)	41.3 (1-5/8)	41.3 (1-5/8)	41.3 (1-5/8)
Dimensions (W x H x D)	mm		(1,240 x1,690 x 760) x 3	(1,240 x1,690 x 760) x 3	(1,240 x1,690 x 760) x 3
	inch		(48-13/16 x 66-17/32 x 29-29/32) x 3	(48-13/16 x 66-17/32 x 29-29/32) x 3	(48-13/16 x 66-17/32 x 29-29/32) x 3
Net Weight	kg		(281 x 2) + (221 x 1)	(281 x 2) + (221 x 1)	(281 x 2) + (221 x 1)
	lbs		(619 x 2) + (487 x 1)	(619 x 2) + (487 x 1)	(619 x 2) + (487 x 1)
Sound Pressure Level	Cooling	dB(A)	66.3	67.4	68.3
	Heating	dB(A)	68.5	68.9	69.3
Sound Power Level	Cooling	dB(A)	90.0	90.0	90.0
	Heating	dB(A)	91.2	91.6	92.0
Communication Cable	No. x mm ² (VCTF-SB)		2C x 1.0 - 1.5	2C x 1.0 - 1.5	2C x 1.0 - 1.5
Refrigerant	Refrigerant name		R410A	R410A	R410A
	Precharged Amount in factory	kg lbs	14.0 + 14.0 + 13.0 30.9 + 30.9 + 28.7	14.0 + 14.0 + 13.0 30.9 + 30.9 + 28.7	14.0 + 14.0 + 13.0 30.9 + 30.9 + 28.7
	Control		Electronic Expansion Valve	Electronic Expansion Valve	Electronic Expansion Valve
Power Supply	Ø, V, Hz		3, 380 - 415, 50	3, 380 - 415, 50	3, 380 - 415, 50
Number of Maximum Connectable Indoor Units			3, 400, 60	3, 400, 60	3, 400, 60

MULTI V 5

TROPICAL MODEL

STANDARD

ARUN620LTH5 / ARUN640LTH5 / ARUN660LTH5



HP			62	64	66
Model Name	Combination Unit		ARUN620LTH5	ARUN640LTH5	ARUN660LTH5
	Independent Unit		ARUN220LTH5 ARUN200LTH5 ARUN200LTH5	ARUN220LTH5 ARUN220LTH5 ARUN200LTH5	ARUN220LTH5 ARUN220LTH5 ARUN220LTH5
Capacity	*Cooling (Rated)	RT	49.3	50.9	52.5
		kW	173.6	179.2	184.8
		Btu/h	592,300	611,400	630,500
	**Cooling (Rated)	RT	41.4	41.8	42.3
		kW	145.6	147.2	148.8
		Btu/h	496,800	502,200	507,700
Heating (Rated)	RT	55.5	57.3	59.0	
	kW	195.3	201.6	207.9	
	Btu/h	666,400	687,900	709,400	
Input	*Cooling (Rated)	kW	40.84	42.68	44.52
	**Cooling (Rated)	kW	48.26	49.21	50.16
	Heating (Rated)	kW	48.58	50.60	52.62
COP	*Cooling (Rated)	kW	4.25	4.20	4.15
	**Cooling (Rated)	kW	3.02	2.99	2.97
	Heating (Rated)	kW	4.02	3.98	3.95
Power Factor	Rated	-	0.93	0.93	0.93
Casing	Color		Warm Gray / Dawn Gray	Warm Gray / Dawn Gray	Warm Gray / Dawn Gray
Heat Exchanger			Wide Louver Plus	Wide Louver Plus	Wide Louver Plus
Compressor	Type		Hermetically Sealed Scroll	Hermetically Sealed Scroll	Hermetically Sealed Scroll
	Piston Displacement	cm ³ /rev	62.1 x 6	62.1 x 6	62.1 x 6
	Number of Revolution	rev/min	3,600 x 6	3,600 x 6	3,600 x 6
	Motor Output x Number	W x No.	5,300 x 6	5,300 x 6	5,300 x 6
	Starting Method		Direct On Line	Direct On Line	Direct On Line
	Oil Type		FVC68D (PVE)	FVC68D (PVE)	FVC68D (PVE)
Fan	Type		Propeller fan	Propeller fan	Propeller fan
	Motor Output x Number	W	900 x 6	900 x 6	900 x 6
	Air Flow Rate(High)	m ³ /min	320 x 3	320 x 3	320 x 3
		ft ³ /min	11,301 x 3	11,301 x 3	11,301 x 3
	External Static Pressure (Max, Pa)		80	80	80
Pipe Connections	Liquid Pipe	mm (inch)	22.2 (7/8)	22.2 (7/8)	22.2 (7/8)
	Gas Pipe	mm (inch)	44.5 (1-3/4)	44.5 (1-3/4)	53.98 (2-1/8)
	Dimensions (W x H x D)	mm	(1,240 x 1,690 x 760) x 3	(1,240 x 1,690 x 760) x 3	(1,240 x 1,690 x 760) x 3
Net Weight		kg	281 x 3	281 x 3	281 x 3
		lbs	619 x 3	619 x 3	619 x 3
Sound Pressure Level	Cooling	dB(A)	67.8	68.6	69.3
	Heating	dB(A)	69.6	70.0	70.3
Sound Power Level	Cooling	dB(A)	90.8	90.8	90.8
	Heating	dB(A)	92.1	92.5	92.8
Communication Cable	No. x mm ² (VCTF-SB)		2C x 1.0 - 1.5	2C x 1.0 - 1.5	2C x 1.0 - 1.5
Refrigerant	Refrigerant name		R410A	R410A	R410A
	Precharged Amount in factory	kg	14.0 + 14.0 + 14.0	14.0 + 14.0 + 14.0	14.0 + 14.0 + 14.0
		lbs	30.9 + 30.9 + 30.9	30.9 + 30.9 + 30.9	30.9 + 30.9 + 30.9
Control			Electronic Expansion Valve	Electronic Expansion Valve	Electronic Expansion Valve
Power Supply	Ø, V, Hz		3, 380 - 415, 50	3, 380 - 415, 50	3, 380 - 415, 50
Number of Maximum Connectable Indoor Units			3, 400, 60	3, 400, 60	3, 400, 60
			64	64	64

NOTE

1. Capacities are based on the following conditions (ISO 15042)

- Cooling Temperature :
 - *Cooling (T1) : Indoor Temperature 27°C(80.6°F) DB/19°C(66.2°F) WB
Outdoor Temperature 35°C(95°F) DB/24°C(75.2°F)
 - **Cooling (T3) : Indoor Temperature 29°C(84.2°F) DB/19°C(66.2°F) WB
Outdoor Temperature 46°C(114.8°F) DB/24°C(75.2°F) WB
- Heating Temperature :
 - Indoor 20°C(68°F) DB / 15°C(59°F) WB
 - Outdoor 7°C(44.6°F) DB / 6°C(42.8°F) WB
- Piping Length : Interconnected Pipe Length = 7.5m
- Height difference between outdoor unit and indoor unit : 0m

2. The Maximum combination ratio is 130%.

3. Wiring cable size must comply with the applicable local and national codes. And "Electric characteristics" chapter should be considered for electrical work and design. Especially the power cable and circuit breaker should be selected in accordance with that.

4. Sound Level Values are measured at Anechoic chamber. Therefore, these values can be increased owing to ambient conditions during operation.

5. Power factor could vary less than ±1% according to the operating conditions.

6. Due to our policy of innovation some specifications may be changed without notification.



Suitable for residences and small offices

MULTI V™ S



Customer Benefits

- Energy saving
- High reliability
- Improved user convenience

CONVENIENT PIPE DIRECTION DESIGN

Free Design & Installation

4 Way Piping



Sufficient pipes length limitation in Design and Installation of immense variety of building.

RI Compressor™

High-Efficiency & Reliability

Seasonal Energy Efficiency **12%**

Lower Noise **4dB**

Extended Operation Range

Max. 150Hz

Revolutionary Scroll Compressor is applied for high-efficiency and reliability. This type of compressor is more advanced compared to the conventional one.

SMART CONTROL

Accurate and Easy Control

Temperature + Pressure Control

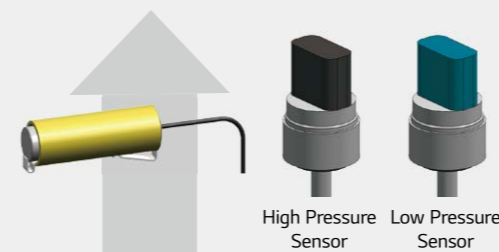

14% Quicker

Pressure Control applied for smart, quick, and precise responds of temperature that user requests.

BIOMIMETIC FAN

Operation Noise Reduction

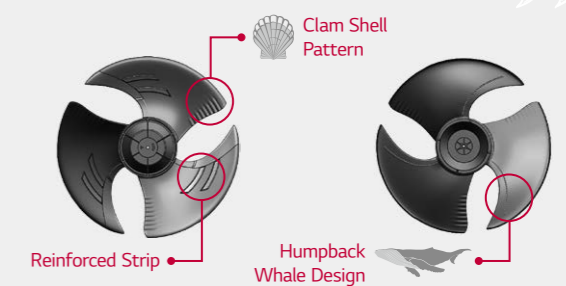

Air Flow **33%**

Lower Noise **3dB**

Compact model

(Size 40%↓, Weight 25%↓)

With biomimetic fan design newly developed fan blows higher air volume also operating noise is decreased. This technology enables a highly efficient compact model.

MULTI V S

Piping Length

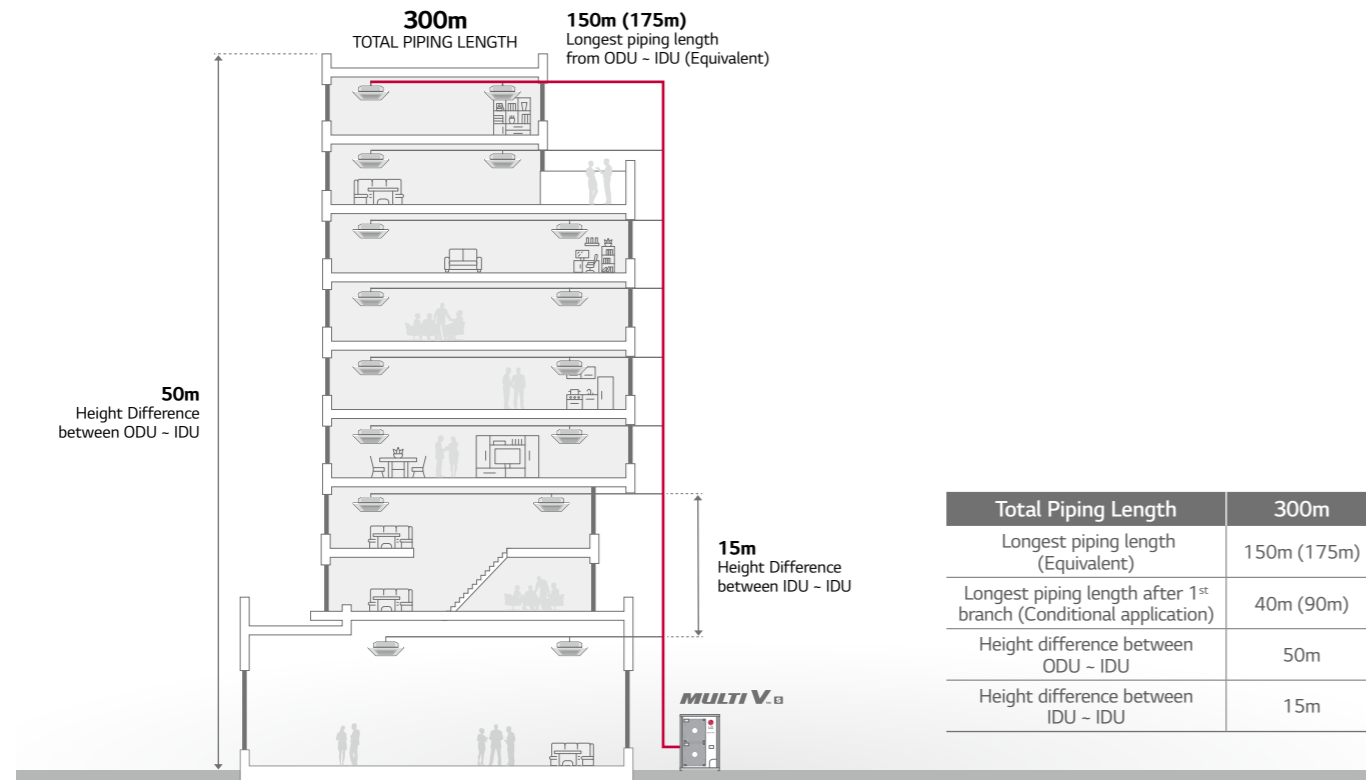

EER / COP / Part load

Saving Energy Cost with High Efficient Product

Heat Pump

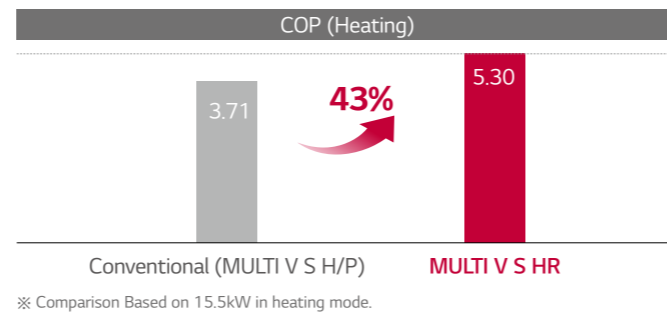
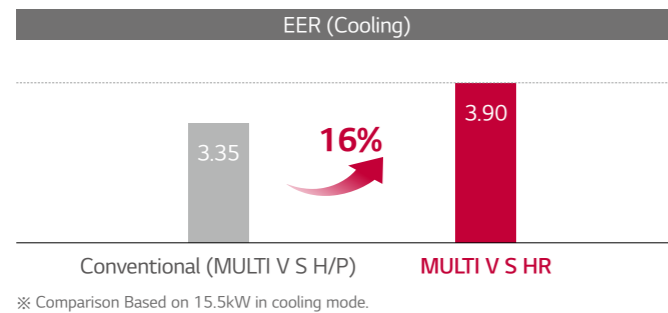

Heat Recovery

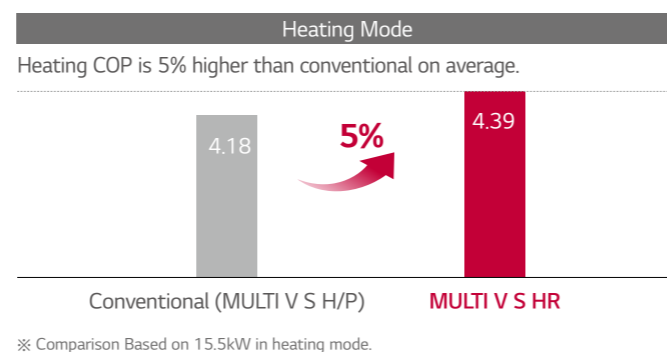
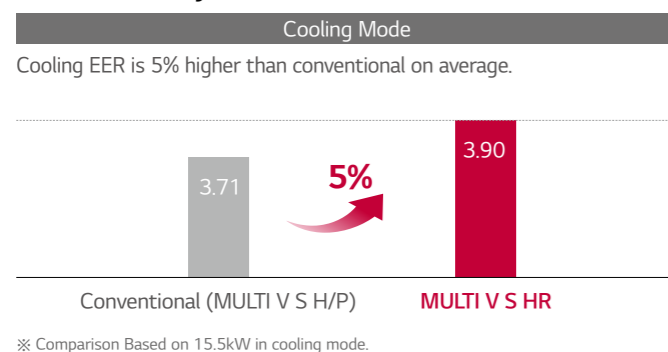

Smart Load Control Applied

Increase comfortable sensation and Max. 23% energy saving thanks to MULTI V load control

MULTI V S changes indoor discharge air temperature continuously according to load, to save energy.

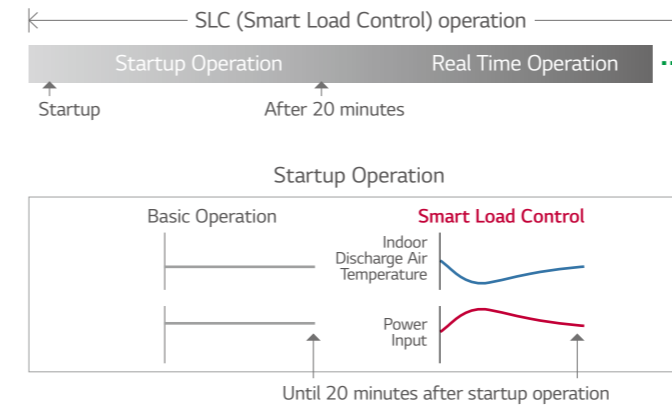

- ※ Indoor air discharge temperature
- Energy efficiency increased by 3-step Smart Load Control during start-up phase
- Discharge air temperature adjusted according to outdoor and indoor temperature
- Comfort level in cooling / heating operations ensured

Max. 10% Energy saving

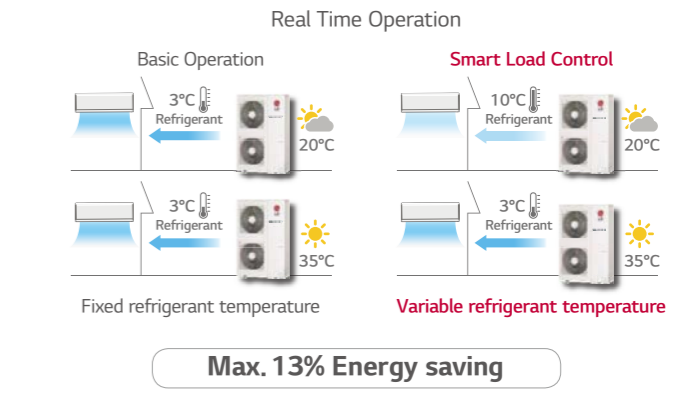

- ※ How to set up : By dip switch in outdoor unit (Referred to Product Data Book) Factory default setting is Off.
- ※ ESEER(European seasonal energy efficiency Ratio) conditions based on 15.5kw unit
- Outdoor temperature condition : EER 100% / 75% / 50% / 25% = 35°C(DB) / 30°C(DB) / 25°C(DB) / 20°C(DB)
- Indoor temperature condition : 27°C(DB) / 19°C(WB)
- ※ Dual sensing (Temperature & humidity) smart load control is possible with Remote controller PTEMTB100 (White) /PREMTB10 (Black)

Inverter Twin Rotary & Inverter Scroll Compressor

Adapted High Efficient Compressor according to Capacity

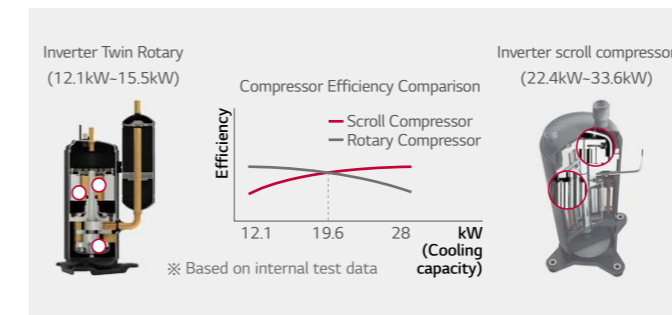

Inverter Twin Rotary

Concentrated Winding Motor
Oil path area is improved by over 50% by increasing the extra stator cavity. Due to this, caloric value of motor is reduced, improving the cooling function of stator coil.

Twin Rotary Rotor
Upper and lower part rotor offset imbalance in shaft rotor rotation. Vibration and noise is reduced. Max. torque load decreased by 45% compared to single rotor.

Surface Coating
Surface coating of outstanding abrasion resistance property on vane and crank shaft.

Inverter Scroll Compressor

World Best Class Compressor Speed

- Rapid response capability
- Compact core design (Concentrated motor)
- Down to 15Hz : Part load efficiency improvement

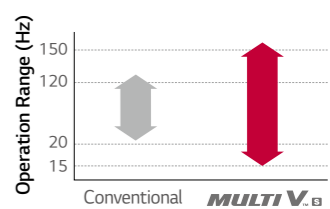

6 By-pass Valve

Compressor reliability is maximized with 6 By-pass Valve

- Prevent compressor damage due to excessively compressed refrigerant more efficiently than 4 by-pass valve

Direct Oil Injection

- Eliminate suction refrigerant gas heat loss through direct oil injection into compression chamber (efficiency increases)
- Reliability increase due to proper oil amount supply

Scroll Profile

- The enhanced reliability by increasing the thickness of scroll central part within largest pressure
- Efficiency increases by expanding 96% bypass area and 1.7% improved volume ratio by non uniform scroll thickness

MULTI V S

Optimal Heat Exchanger

Maximize Efficiency according to different Heat Exchanger path by cooling and heating (LG's own technology)

Variable Heat Exchanger Circuit intelligently selects the optimal path for both heating and cooling operations. With this smart path selection technology, an average of 6% increase in the efficiency of both operations has been achieved. The paths number and circuit velocity are adjusted to match temperatures and operation modes in order to maximize efficiency instead of compromising efficiency for each operation when the number and direction of paths are fixed independently of temperature operation mode.

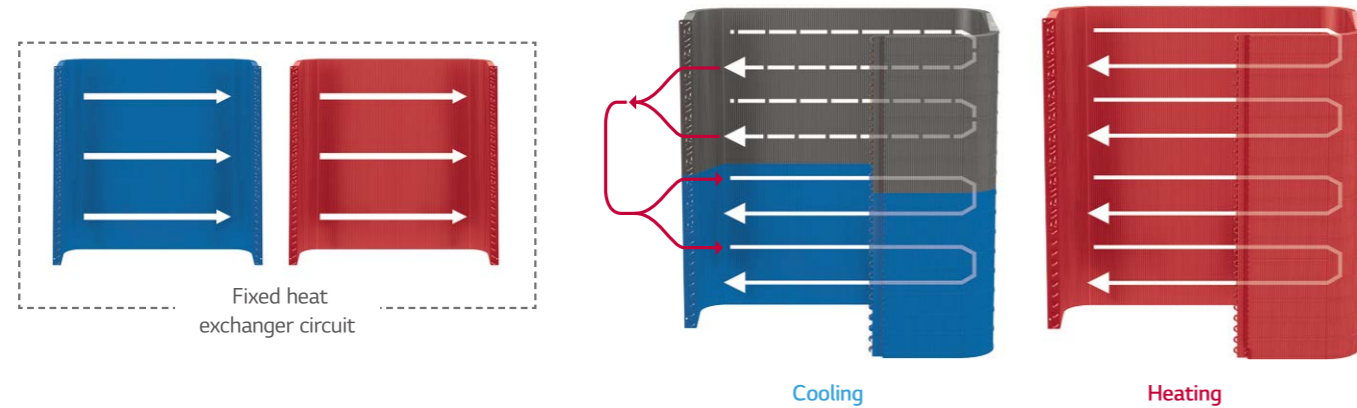

Efficiency performance

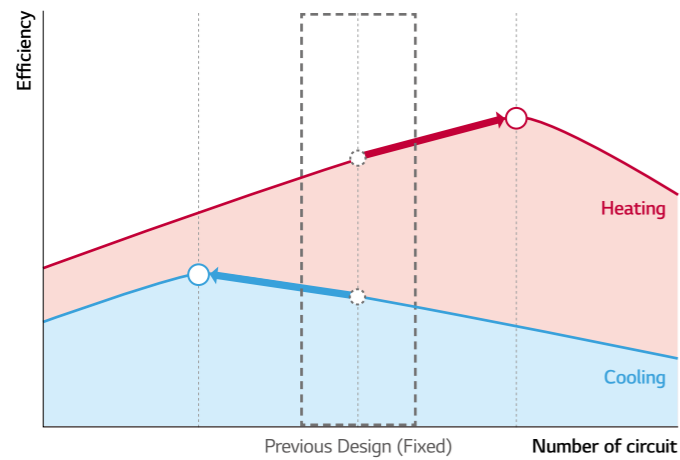

Efficiency up due to Fin shape

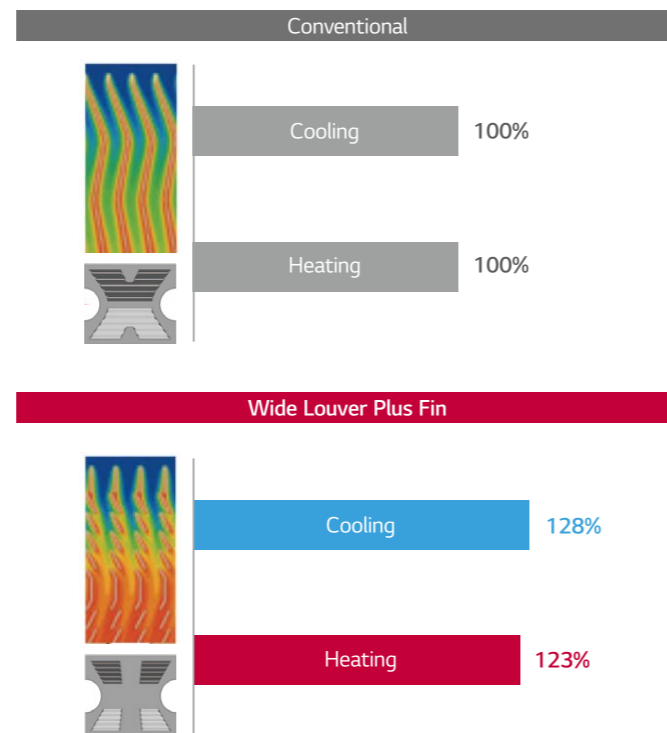

High Reliability of Refrigerant Components

Superior Performance and Strong Durable Components are developed by LG's technologies

MULTI V S improved reliability through an excellent technique of Oil separator / Accumulator / Sub-cooling.

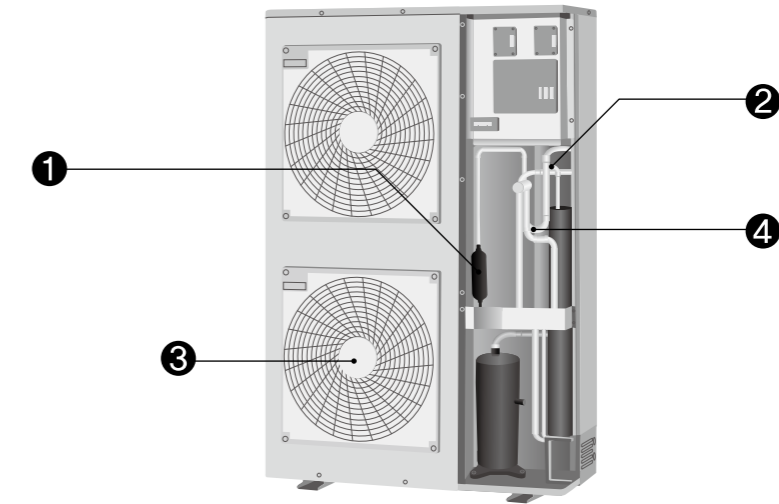

1 Cyclonic Oil Separator

- Highly reliable and efficient oil separation by centrifuge using cyclonic methods.
- High collection efficiency as well as outstanding resistance to high temperature and pressure.

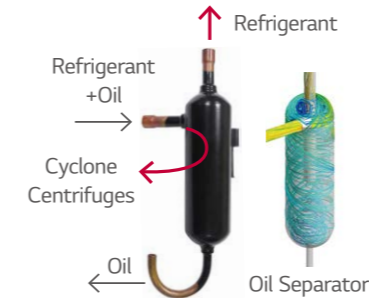

3 BLDC Fan Motor

- The BLDC Fan motor is more efficient than a conventional AC motor, offering an additional 40% energy savings at low speeds and 20% at high speeds.

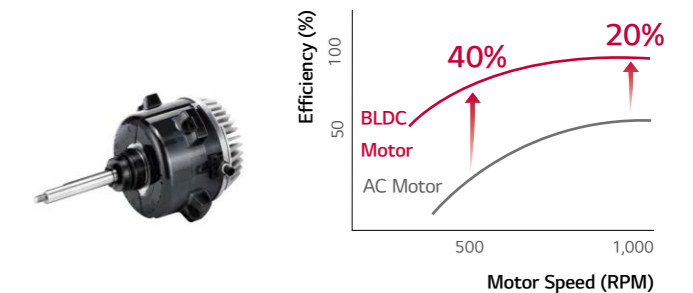

2 Large Volume Accumulator

- Improved reliability by adopting the large volume accumulator (38% volume up compared to conventional).
- Prevents the liquid refrigerant entering the compressor suction.
- Maximize efficiency by optimal amount of refrigerant.
- Protect compressor break down and Increase life time.



4 Double Sub-cool Interchanger

- Reliability is enhanced by minimizing pressure drop due to high efficiency spiral structure and 2 times larger size.
- Long pipe is possible (up to* 175m) and high elevation (up to* 50m).
- Reduction of indoor refrigerant noise level.

* Based on equivalent pipe length.

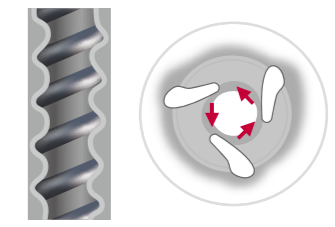

MULTI V S

Smart Control

Pressure Control applied for smart, quick, and precise responds of temperature that user requests

Temperature + Pressure Control

Senses and controls pressure directly using pressure sensor for faster and more exact response to load variation.

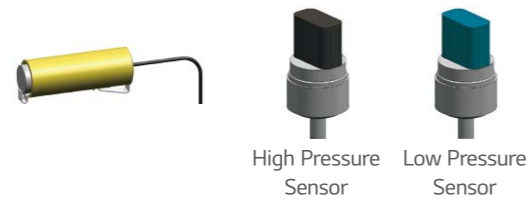

Quick Operating Response

Pressure control takes up to 14% less time in cooling mode, to reach the desired temperature. The indoor environment can be controlled more accurately and more comfortable.

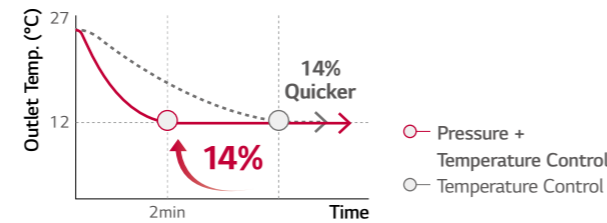

※ Specifications may vary for each model.

Heat Exchanger with Ocean Black Fin for Corrosion Resistance

Strong Durability against high salinity and heavily polluted air

LG's exclusive Ocean Black Fin is applied on the heat exchanger of MULTI V S in order to perform even in corrosive environments. The strong protection from various corrosive external environments such as seaside with high salt contamination and industrial cities with severe air pollution caused by fumes from factories keeps MULTI V S operating without breakdown. This improvement in durability prolongs the product's lifespan and lowers both the operational and maintenance costs.

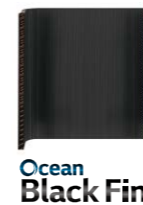

Corrosion Resistance Proven by Certified Tests

LG Corrosion Resistance solution passed ISO 21207 accelerated corrosion test conducted by an independent test organization and the result has been certified by prestigious global certification organization, TÜV(Underwriters Laboratories).

Certified protection



Condition of salt spray test

Temperature	35°C
Mist of 5% sodium chloride solution	

Condition of gas exposure test

R.H.	NO ₂	SO ₂
95%	10 x 10 ⁻⁵	5 x 10 ⁻⁶

Enhanced Coating Layers

The black coating with enhanced epoxy resin is applied for strong protection from various corrosive external conditions such as salt contamination and air pollution including fumes from factories. Moreover, the hydrophilic film keeps water from accumulating on the heat exchanger's fin, minimizing moisture buildup and eventually making it even more corrosion resistant.

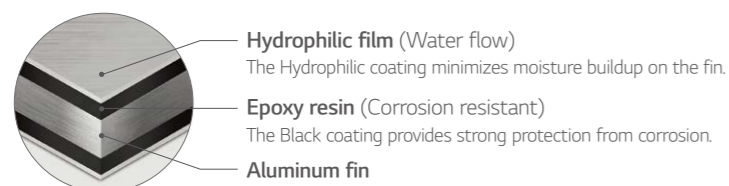

Sufficient Pipe Length Limit

Sufficient pipes length limitation in Design and Installation of immense variety of building

MULTI V S inverter technology and sub cooling control circuit technology allows greater piping length and outstanding elevation differences. A cooling system can be implemented more flexibly in a shop, office and even high-rise building, reducing the designer's work time and providing more efficient design.

Piping Capabilities

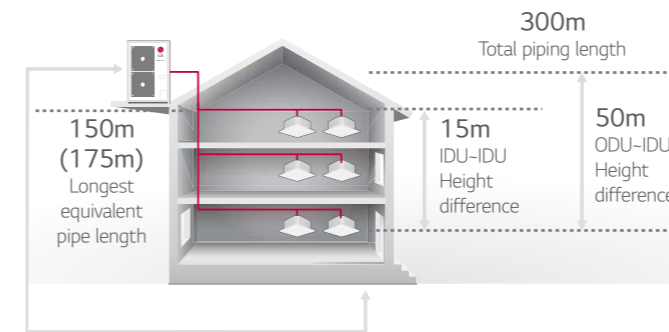

4 Way Piping

Free design and installation by 4 way piping

At night mode, noise reduced maximum 14% compared to normal mode.

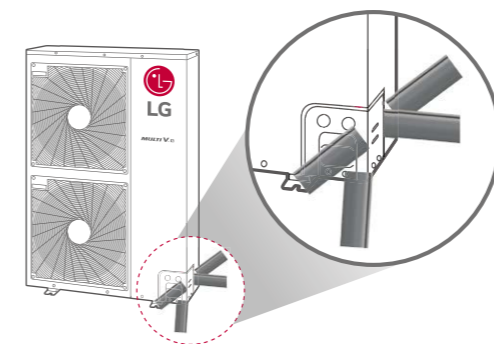

Low Noise Operation

Free from noise at any time with low noise operation function

At night mode, noise reduced maximum 14% compared to normal mode.

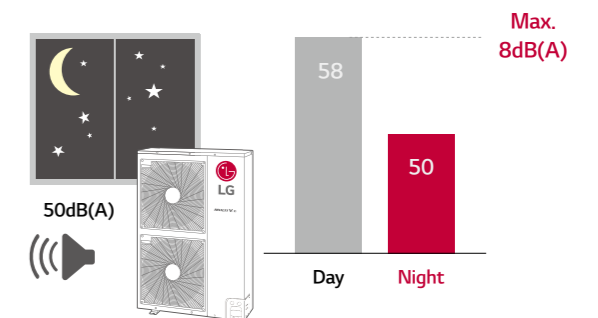
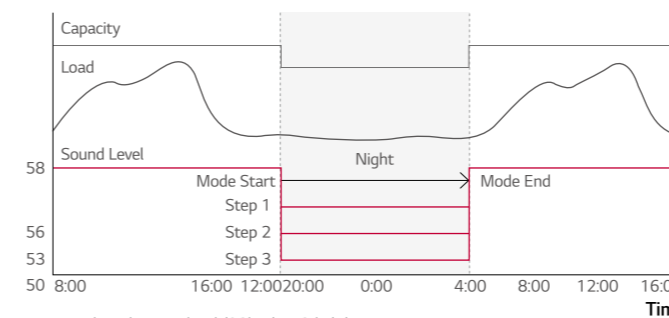

※ Normal mode noise level (28kW) : 58dB(A)
 ※ Night 3 step noise level (28kW) : 56dB(A), 53dB(A), 50dB(A)
 ※ Sound pressure tested by following conditions : 1m distance / 1.5m height

MULTI V S

Biomimetic Fan

With biomimetic fan design, newly developed fan blows higher air volume, also operating noise is decreased. This technology enables a highly efficient compact model.

Previous	New
<ul style="list-style-type: none"> • General fan design • Sound pressure level 53.1dB(A) (110CMM / 2 fan) • Max. Air flow up to 60 CMM (800RPM / 124W Motor x 1EA) 	<ul style="list-style-type: none"> • Biomimetic fan design • Sound pressure level 49.6dB(A) (110CMM / 2 fan) • Max. Air flow up to 86CMM* (1,000RPM / 200W Motor x 1EA)

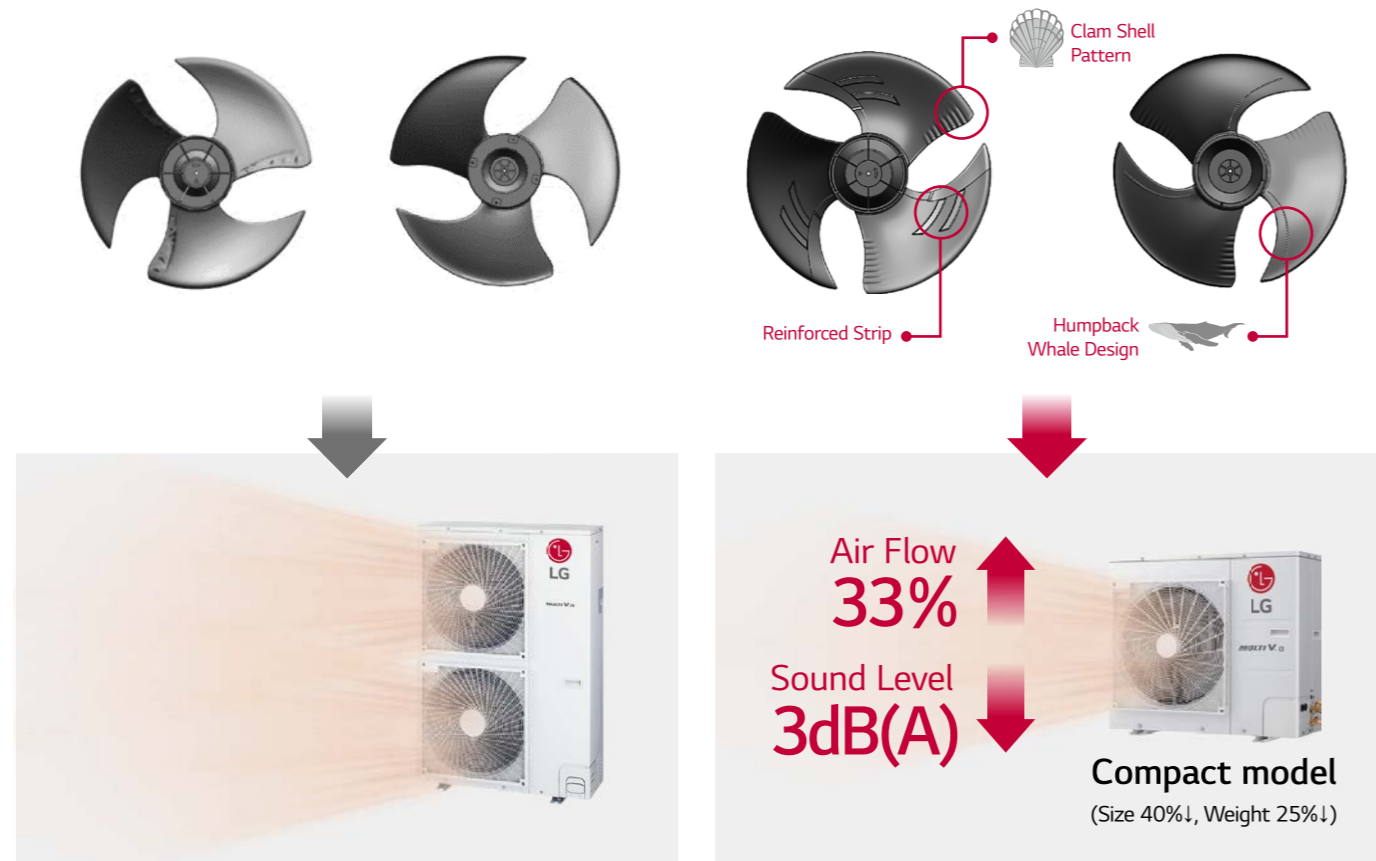

* The value is based on 5,6HP model.

Fan Technology and RPM Control

External static pressure control for outdoor unit fan to adapt more flexibly to various installation conditions of outdoor units

For efficient operation, newly developed fan blows higher air volume and has more high static pressure, also operating noise is decreased.

Fan Technology

The new axial fan has a mogul trailing edge, narrow hub blade and reverse hub, this provides a high efficiency, low noise, wide fan, as well as improving the air flow rate.

Super cannon fan increases the air volume in 50CMM and the noise level is decreased by 4dB(A).

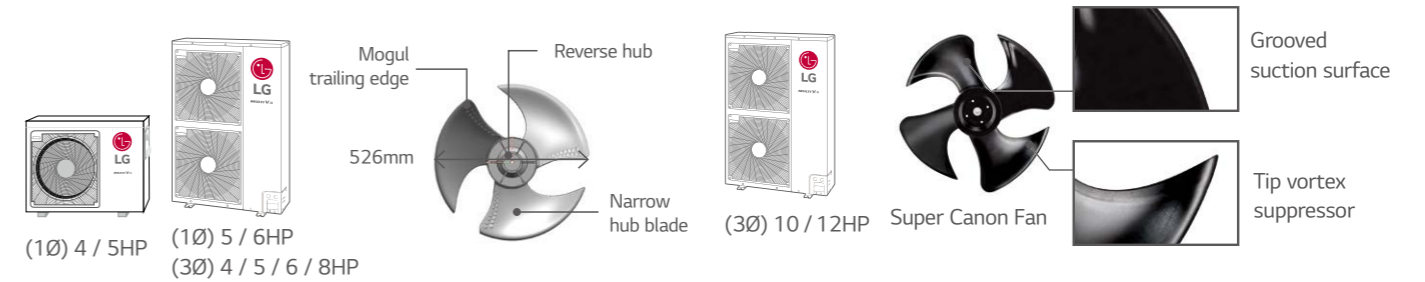

Fan RPM Control

Flow of air has straightness due to fan shroud and Fan RPM control even in high-rise building.

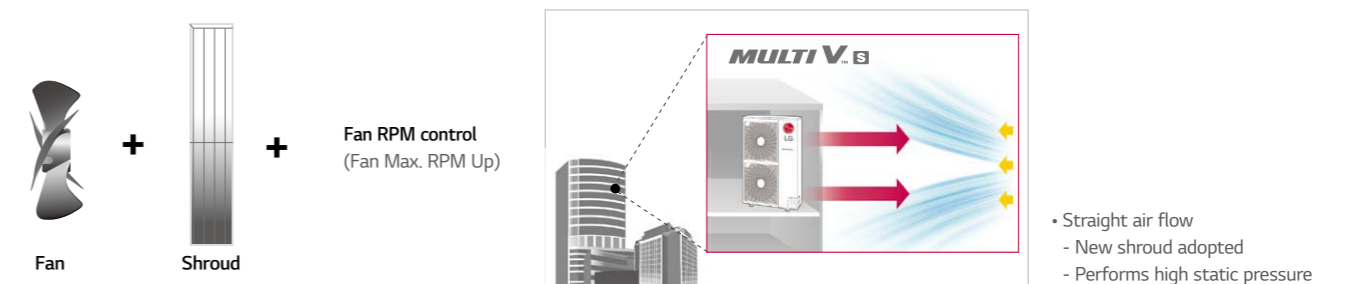

Upgraded Fault Detection and Diagnosis

Easy and convenient maintenance with self-diagnosis

The inclusion of FDD elements - Auto start-up, auto refrigerant check, black box functionality, simultaneous evaluation, and auto refrigerant collection, provides the optimal solution for user reliability and ease of maintenance.

- Auto commissioning Mode
- Auto Refrigerant Collection
- Auto evaluation of refrigerant amount and charging
- Able to access LGMV (LG Monitoring View) by smartphone
- Black box function
- Piping & wiring error check-up

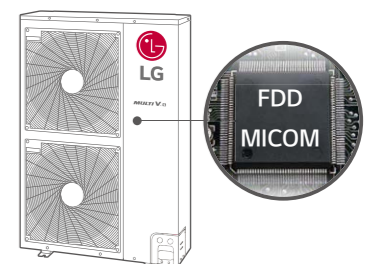

MULTI V S

Non TROPICAL MODEL

HEAT PUMP

ARUN040GSS0 / ARUN050GSLO



HP			4	5
Model Name	Combination Unit		ARUN040GSS0	ARUN050GSLO
Capacity (Rated)	Cooling	kW	12.1	14.0
	Heating	kW	12.5	15.0
Input (Rated)	Cooling	kW	3.78	4.38
	Heating	kW	2.10	2.65
EER			3.20	3.20
COP			5.94	5.66
Compressor	Type		BLDC Inverter Twin Rotary	BLDC Inverter Twin Rotary
	Piston Displacement	cm ³ /rev	44.2	44
	Motor Output	W	4,000	4,000
	Starting Method		DC Inverter Starting	DC Inverter Starting
Fan	Type		Axial Flow Fan	Axial Flow Fan
	Motor Output x Number	W	124 x 1	124 x 1
	Air Flow Rate (High)	m ³ /min	60	60
		ft ³ /min	2,119	2,119
	Drive		DC INVERTER	DC INVERTER
Discharge	Side / Top		Side	Side
	Liquid	mm (inch)	Ø9.52 (3/8)	Ø9.52 (3/8)
Pipe Connections	Gas		mm (inch)	Ø15.88 (5/8)
	Dimensions (W x H x D)		mm	950 x 834 x 330
Net Weight			kg	70
Sound Pressure Level	Cooling	dB(A)	50	52
	Heating	dB(A)	52	58
Sound Power Level	Cooling	dB(A)	72	72
	Heating	dB(A)	75	75
Communication Cable	No. x mm ² (VCTF-SB)		2C x 1.0 - 1.5	2C x 1.0 - 1.5
Refrigerant	Refrigerant name		R410A	R410A
	Precharged Amount	kg	1.8	2.4
		lbs	4.0	5.3
	GWP		2,087.5	2,087.5
	t-CO ₂ eq		3.8	5.0
Control		Electronic Expansion Valve	Electronic Expansion Valve	
Refrigerant Oil	Type		FVC68D (PVE)	FVC68D (PVE)
	Charge	cc	1,300	1,300
Power Supply	Ø, V, Hz		1, 220 - 240, 50	1, 220 - 240, 50
			1, 220, 60	1, 220, 60
Number of Maxmum Connectable Indoor Units			8	10

- Note : 1. Eurovent Test Condition : Type of indoor unit connected is only Ceiling Concealed Duct.
 - Refer to EUROVENT certification regulation for more detail test conditions.
 - Refer to EUROVENT website for test values connected Ceiling Cassette type indoors.
 2. Performances are based on the following conditions :
 - Cooling Temperature : Indoor 27°C(80.6°F) DB / 19°C(66.2°F) WB / Outdoor 35°C(95°F) DB / 24°C(75.2°F) WB
 - Heating Temperature : Indoor 20°C(68°F) DB / 15°C(59°F) WB / Outdoor 7°C(44.6°F) DB / 6°C(42.8°F) WB
 3. The maximum combination ratio is 160% (the maximum combination ratio of ARUN050GSLO is 130%)
 4. Wiring cable size must comply with the applicable local and national codes.
 5. Due to our policy of innovation some specifications may be changed without notification.
 6. Sound Level Values are measured at Anechoic chamber. Therefore, these values can be increased owing to ambient conditions during operation.
 7. Power factor could vary less than ±1% according to the operating conditions.
 8. This product contains Fluorinated greenhouse gases.(R410A, GWP(Global warming potential) = 2087.5)

Non TROPICAL MODEL

HEAT PUMP

ARUN050GSS0 / ARUN060GSS0



LG participates in the ECP programme for EUROVENT VRF program.
 Check ongoing validity of certification
 : www.eurovent-certification.com

HP			5	6
Model Name	Combination Unit		ARUN050GSS0	ARUN060GSS0
Capacity (Rated)	Cooling	kW	14.0	15.5
	Heating	kW	16.0	18.0
Input (Rated)	Cooling	kW	3.33	3.97
	Heating	kW	2.77	3.40
EER			4.20	3.90
COP			5.77	5.30
Compressor	Type		BLDC Inverter Twin Rotary	BLDC Inverter Twin Rotary
	Piston Displacement	cm ³ /rev	44.2	44.2
	Motor Output	W	4,000	4,000
	Starting Method		DC Inverter Starting	DC Inverter Starting
Fan	Type		Axial Flow Fan	Axial Flow Fan
	Motor Output x Number	W	124 x 2	124 x 2
	Air Flow Rate (High)	m ³ /min	110	110
		ft ³ /min	3,885	3,885
	Drive		DC INVERTER	DC INVERTER
Discharge	Side / Top		Side	Side
	Liquid	mm (inch)	Ø9.52 (3/8)	Ø9.52 (3/8)
Pipe Connections	Gas		mm (inch)	Ø15.88 (5/8)
	Dimensions (W x H x D)		mm	950 x 1,380 x 330
Net Weight			kg	94
Sound Pressure Level	Cooling	dB(A)	51	52
	Heating	dB(A)	53	54
Sound Power Level	Cooling	dB(A)	72	72
	Heating	dB(A)	76	77
Communication Cable	No. x mm ² (VCTF-SB)		2C x 1.0 - 1.5	2C x 1.0 - 1.5
Refrigerant	Refrigerant name		R410A	R410A
	Precharged Amount	kg	3.0	3.0
		lbs	6.6	6.6
	GWP		2,087.5	2,087.5
	t-CO ₂ eq		6.3	6.3
Control		Electronic Expansion Valve	Electronic Expansion Valve	
Refrigerant Oil	Type		FVC68D (PVE)	FVC68D (PVE)
	Charge	cc	1,300	1,300
Power Supply	Ø, V, Hz		1, 220 - 240, 50	1, 220 - 240, 50
			1, 220, 60	1, 220, 60
Number of Maxmum Connectable Indoor Units			10	13

- Note : 1. Eurovent Test Condition : Type of indoor unit connected is only Ceiling Concealed Duct.
 - Refer to EUROVENT certification regulation for more detail test conditions.
 - Refer to EUROVENT website for test values connected Ceiling Cassette type indoors.
 2. Performances are based on the following conditions :
 - Cooling Temperature : Indoor 27°C(80.6°F) DB / 19°C(66.2°F) WB / Outdoor 35°C(95°F) DB / 24°C(75.2°F) WB
 - Heating Temperature : Indoor 20°C(68°F) DB / 15°C(59°F) WB / Outdoor 7°C(44.6°F) DB / 6°C(42.8°F) WB
 3. The maximum combination ratio is 160% (the maximum combination ratio of ARUN050GSLO is 130%)
 4. Wiring cable size must comply with the applicable local and national codes.
 5. Due to our policy of innovation some specifications may be changed without notification.
 6. Sound Level Values are measured at Anechoic chamber. Therefore, these values can be increased owing to ambient conditions during operation.
 7. Power factor could vary less than ±1% according to the operating conditions.
 8. This product contains Fluorinated greenhouse gases.(R410A, GWP(Global warming potential) = 2087.5)

MULTI V S

Non TROPICAL MODEL

HEAT PUMP

ARUN040LSS0 / ARUN050LSS0 / ARUN060LSS0

 LG participates in the ECP programme for EUROVENT VRF program. Check ongoing validity of certification : www.eurovent-certification.com



HP			4	5	6
Model Name	Combination Unit		ARUN040LSS0	ARUN050LSS0	ARUN060LSS0
Capacity (Rated)	Cooling	kW	12.1	14.0	15.5
	Heating	kW	12.5	16.0	18.0
Input (Rated)	Cooling	kW	2.37	3.33	3.97
	Heating	kW	1.93	2.77	3.40
EER			5.10	4.20	3.90
COP			6.49	5.77	5.30
Compressor	Type		BLDC Inverter Twin Rotary	BLDC Inverter Twin Rotary	BLDC Inverter Twin Rotary
	Piston Displacement	cm ³ /rev	44.2	44.2	44.2
	Motor Output	W	4,000	4,000	4,000
	Starting Method		DC Inverter Starting	DC Inverter Starting	DC Inverter Starting
Fan	Type		Axial Flow Fan	Axial Flow Fan	Axial Flow Fan
	Motor Output x Number	W	124 x 2	124 x 2	124 x 2
	Air Flow Rate (High)	m ³ /min	110	110	110
		ft ³ /min	3,885	3,885	3,885
	Drive		DC INVERTER	DC INVERTER	DC INVERTER
Discharge	Side / Top		Side	Side	Side
Pipe Connections	Liquid	mm (inch)	Ø9.52 (3/8)	Ø9.52 (3/8)	Ø9.52 (3/8)
	Gas	mm (inch)	Ø15.88 (5/8)	Ø15.88 (5/8)	Ø19.05 (3/4)
Dimensions (W x H x D)		mm	950 x 1,380 x 330	950 x 1,380 x 330	950 x 1,380 x 330
Net Weight		kg	96	96	96
Sound Pressure Level	Cooling	dB(A)	50	51	52
	Heating	dB(A)	52	53	54
Sound Power Level	Cooling	dB(A)	72	72	72
	Heating	dB(A)	76	76	77
Communication Cable		No. x mm ² (VCTF-SB)	2C x 1.0 - 1.5	2C x 1.0 - 1.5	2C x 1.0 - 1.5
Refrigerant	Refrigerant name		R410A	R410A	R410A
	Precharged Amount	kg	3.0	3.0	3.0
		lbs	6.6	6.6	6.6
	GWP		2,087.5	2,087.5	2,087.5
	t-CO ₂ eq		6.3	6.3	6.3
Control		Electronic Expansion Valve	Electronic Expansion Valve	Electronic Expansion Valve	
Refrigerant Oil	Type		FVC68D (PVE)	FVC68D (PVE)	FVC68D (PVE)
	Charge	cc	1,300	1,300	1,300
Power Supply		Ø, V, Hz	3, 380 - 415, 50	3, 380 - 415, 50	3, 380 - 415, 50
			3, 380, 60	3, 380, 60	3, 380, 60
Number of Maxmum Connectable Indoor Units			8	10	13

- Note : 1. Eurovent Test Condition : Type of indoor unit connected is only Ceiling Concealed Duct.
 - Refer to EUROVENT certification regulation for more detail test conditions.
 - Refer to EUROVENT website for test values connected Ceiling Cassette type indoors.
 2. Performances are based on the following conditions :
 - Cooling Temperature : Indoor 27°C(80.6°F) DB / 19°C(66.2°F) WB / Outdoor 35°C(95°F) DB / 24°C(75.2°F) WB
 - Heating Temperature : Indoor 20°C(68°F) DB / 15°C(59°F) WB / Outdoor 7°C(44.6°F) DB / 6°C(42.8°F) WB
 3. The maximum combination ratio is 160% (the maximum combination ratio of ARUN050GSL0 is 130%)
 4. Wiring cable size must comply with the applicable local and national codes.
 5. Due to our policy of innovation some specifications may be changed without notification.
 6. Sound Level Values are measured at Anechoic chamber. Therefore, these values can be increased owing to ambient conditions during operation.
 7. Power factor could vary less than ±1% according to the operating conditions.
 8. This product contains Fluorinated greenhouse gases.(R410A, GWP(Global warming potential) = 2087.5)

Non TROPICAL MODEL

HEAT PUMP

ARUN080LSS0 / ARUN100LSS0 / ARUN120LSS0

 LG participates in the ECP programme for EUROVENT VRF program. Check ongoing validity of certification : www.eurovent-certification.com



HP			8	10	12
Model Name	Combination Unit		ARUN080LSS0	ARUN100LSS0	ARUN120LSS0
Capacity (Rated)	Cooling	kW	22.4	28.0	33.6
	Heating	kW	24.5	30.6	36.7
Input (Rated)	Cooling	kW	8.30	8.75	14.00
	Heating	kW	6.62	8.12	7.46
EER			2.70	3.20	2.40
COP			3.70	3.77	4.92
Compressor	Type		Hermetically Sealed Scroll	Hermetically Sealed Scroll	Hermetically Sealed Scroll
	Piston Displacement	cm ³ /rev	43.8	62.1	62.1
	Motor Output	W	4,200	5,300	5,300
	Starting Method		Direct On Line	Direct On Line	Direct On Line
Fan	Type		Propeller fan	Propeller fan	Propeller fan
	Motor Output x Number	W	124 x 2	250 x 2	250 x 2
	Air Flow Rate (High)	m ³ /min	140	190	190
		ft ³ /min	4,944	6,710	6,710
	Drive		DC INVERTER	DC INVERTER	DC INVERTER
Discharge	Side / Top		Side	Side	Side
Pipe Connections	Liquid	mm (inch)	Ø9.52 (3/8)	Ø9.52 (3/8)	Ø12.7 (1/2)
	Gas	mm (inch)	Ø19.05 (3/4)	Ø22.2 (7/8)	Ø28.58 (1 1/8)
Dimensions (W x H x D)		mm	950 x 1,380 x 330	1,090 x 1,625 x 380	1,090 x 1,625 x 380
Net Weight		kg	115	144	157
Sound Pressure Level	Cooling	dB(A)	57	58	60
	Heating	dB(A)	57	58	60
Sound Power Level	Cooling	dB(A)	81	80	81
	Heating	dB(A)	84	84	85
Communication Cable		No. x mm ² (VCTF-SB)	2C x 1.0 - 1.5	2C x 1.0 - 1.5	2C x 1.0 - 1.5
Refrigerant	Refrigerant name		R410A	R410A	R410A
	Precharged Amount	kg	3.5	4.5	6.0
		lbs	7.7	9.9	13.2
	GWP		2,087.5	2,087.5	2,087.5
	t-CO ₂ eq		7.3	9.4	12.5
Control		Electronic Expansion Valve	Electronic Expansion Valve	Electronic Expansion Valve	
Refrigerant Oil	Type		FVC68D (PVE)	FVC68D (PVE)	FVC68D (PVE)
	Charge	cc	2,400	2,600	3,400
Power Supply		Ø, V, Hz	3, 380 - 415, 50	3, 380 - 415, 50	3, 380 - 415, 50
			3, 380, 60	3, 380, 60	3, 380, 60
Number of Maxmum Connectable Indoor Units			13	16	20

- Note : 1. Eurovent Test Condition : Type of indoor unit connected is only Ceiling Concealed Duct.
 - Refer to EUROVENT certification regulation for more detail test conditions.
 - Refer to EUROVENT website for test values connected Ceiling Cassette type indoors.
 2. Performances are based on the following conditions :
 - Cooling Temperature : Indoor 27°C(80.6°F) DB / 19°C(66.2°F) WB / Outdoor 35°C(95°F) DB / 24°C(75.2°F) WB
 - Heating Temperature : Indoor 20°C(68°F) DB / 15°C(59°F) WB / Outdoor 7°C(44.6°F) DB / 6°C(42.8°F) WB
 3. The maximum combination ratio is 160% (the maximum combination ratio of ARUN050GSL0 is 130%)
 4. Wiring cable size must comply with the applicable local and national codes.
 5. Due to our policy of innovation some specifications may be changed without notification.
 6. Sound Level Values are measured at Anechoic chamber. Therefore, these values can be increased owing to ambient conditions during operation.
 7. Power factor could vary less than ±1% according to the operating conditions.
 8. This product contains Fluorinated greenhouse gases.(R410A, GWP(Global warming potential) = 2087.5)

MULTI V S

Non TROPICAL MODEL

HEAT RECOVERY

ARUB060GSS4

 LG participates in the ECP programme for EUROVENT VRF program. Check ongoing validity of certification : www.eurovent-certification.com



HP	6		
Model	ARUB060GSS4		
Capacity (Rated)	Cooling	Nom	kW
	Heating	Nom	kW
Power Input (Rated)	Cooling	Nom	kW
	Heating	Nom	kW
EER	3.90		
COP	4.39		
ESEER	7.15		
SLC ESEER	8.05		
Compressor	Type	Hermetically Sealed Scroll	
	Piston Displacement	cm ³ /rev	43.8
	Motor Output	W	4,200
	Starting Method	DC Inverter Starting	
Fan	Type	Axial Flow Fan	
	Motor Output x Number	W	124 x 2
	Air Flow Rate (High)	m ³ /min	110
		ft ³ /min	3,885
Drive	DC INVERTER		
Pipe Connections	Discharge	Side / Top	
	Liquid	mm (inch)	Ø9.52 (3/8)
	Low Pressure Gas	mm (inch)	Ø19.05 (3/4)
Dimensions (W x H x D)	High Pressure Gas	mm (inch)	Ø15.88 (5/8)
	mm	950 x 1,380 x 330	
Net Weight	kg	118	
Sound Pressure Level	Cooling	dB(A)	56
	Heating	dB(A)	58
Sound Power Level	Cooling	dB(A)	69
	Heating	dB(A)	71
Communication Cable	No. x mm ² (VCTF-SB)	2C x 1.0 - 1.5	
Refrigerant	Refrigerant Name	R410A	
	Precharged Amount	kg	3.5
	t-CO ₂ eq	7.3	
Refrigerant Oil	Control	Electronic Expansion Valve	
	Type	FVC68D (PVE)	
Power Supply	Charge	cc	1,300
	Ø, V, Hz	1, 220 - 240, 50	
Number of Maximum Connectable Indoor Units	13		

TROPICAL MODEL

HEAT PUMP

ARUN040LSH5 / ARUN050LSH5 / ARUN060LSH5



HP	4		5		6	
Model Name	Independent Unit		ARUN040LSH5		ARUN050LSH5	
Capacity (Rated)	*Cooling - T1 35°C	RT	3.2	4.0	4.4	
		kW	11.2	14.0	15.5	
	**Cooling - T3 46°C	Btu/h	38,200	47,800	52,900	
		RT	2.7	3.4	3.8	
	Heating	kW	9.5	11.9	13.2	
		Btu/h	32,400	40,600	45,000	
Input (Rated)	*Cooling - T1 35°C	RT	3.6	4.5	5.1	
		kW	12.5	16.0	18.0	
	**Cooling - T3 46°C	Btu/h	42,700	54,600	61,400	
		kW	2.60	3.38	3.96	
COP	*Cooling - T1 35°C	kW / kW	4.31	4.14	3.91	
	**Cooling - T3 46°C	kW / kW	3.40	3.25	3.10	
	Heating	kW / kW	4.55	4.55	4.40	
Power Factor	Rated	-	0.93	0.93	0.93	
Casing Color	Warm Gray		Warm Gray		Warm Gray	
Heat Exchanger	Wide Louver Plus		Wide Louver Plus		Wide Louver Plus	
Compressor	Type	LG Inverter Scroll		DC Inverter Rotary		
	Piston Displacement	cm ³ /rev	31.6	31.6	44.2	
	Number of Revolution	rev/min	3,600	3,600	3,600	
	Motor Output x Number	W x No.	3,198 x 1	3,198 x 1	4,000 x 1	
	Starting Method	DC Inverter Starting		Inverter		
	Oil Type	FW68D		FVC68D (PVE)		
Fan	Type	Axial Flow Fan		Propeller fan		
	Motor Output x Number	W	200 x 1	200 x 1	124 x 2	
	Air Flow Rate (High)	m ³ /min	80	80	110	
		ft ³ /min	2,824	2,824	3,885	
Drive	DC Inverter		DC Inverter			
Piping Connections	Discharge	Side / Top	Side	Side	Side	
	Liquid	mm (inch)	Ø9.52 (3/8)	Ø9.52 (3/8)	Ø9.52 (3/8)	
	Gas	mm (inch)	Ø15.88 (5/8)	Ø15.88 (5/8)	Ø19.05 (3/4)	
Dimensions (W x H x D)	mm	950 x 834 x 330		950 x 834 x 330		
	inch	37-13/32 x 32-27/32 x 13		37-13/32 x 32-27/32 x 13		
Net Weight	kg	72		96		
	lbs	159		212		
Sound Press Level	Cooling	dB(A)	50	50	52.0	
	Heating	dB(A)	52	52	54.0	
Sound Power Level	dB(A)	70 - 74		70 - 74		
Communication Cable	No. x mm ² (VCTF-SB)	2C x 1.0 - 1.5		2C x 1.0 - 1.5		
Refrigerant	Refrigerant name	R410A		R410A		
	Precharged Amount	kg	2.4	2.4	3.0	
	lbs	5.3	5.3	6.6		
Power Supply	Control	Electronic Expansion Valve		Electronic Expansion Valve		
	Ø, V, Hz	3, 380 - 415, 50		3, 380 - 415, 50		
Number of Maximum Connectable Indoor Units	3, 400, 60		3, 400, 60		3, 400, 60	
	8		10		9	

Note : 1. Eurovent Test Condition : Type of indoor unit connected is only Ceiling Concealed Duct.
 - Refer to EUROVENT certification regulation for more detail test conditions.
 - Refer to EUROVENT website for test values connected Ceiling Cassette type indoors.
 2. Performances are based on the following conditions :
 - Cooling Temperature : Indoor 27°C(80.6°F) DB / 19°C(66.2°F) WB / Outdoor 35°C(95°F) DB / 24°C(75.2°F) WB
 - Heating Temperature : Indoor 20°C(68°F) DB / 15°C(59°F) WB / Outdoor 7°C(44.6°F) DB / 6°C(42.8°F) WB
 3. The maximum combination ratio is 160% (the maximum combination ratio of ARUN050GSL0 is 130%)
 4. Wiring cable size must comply with the applicable local and national codes.
 5. Due to our policy of innovation some specifications may be changed without notification.
 6. Sound Level Values are measured at Anechoic chamber. Therefore, these values can be increased owing to ambient conditions during operation.
 7. Power factor could vary less than ±1% according to the operating conditions.
 8. This product contains Fluorinated greenhouse gases.(R410A, GWP(Global warming potential) = 2087.5)

Note : 1. Capacities are based on the following conditions (ISO 15042)
 - Cooling Temperature : *Cooling (T1) : Indoor Temperature 27°C(80.6°F) DB/19°C(66.2°F) WB / Outdoor Temperature 35°C(95°F) DB/24°C(75.2°F) WB
 **Cooling (T3) : Indoor Temperature 29°C(84.2°F) DB/19°C(66.2°F) WB / Outdoor Temperature 46°C(114.8°F) DB/24°C(75.2°F) WB
 - Heating Temperature : Indoor 20°C(68°F) DB / 15°C(59°F) WB / Outdoor 7°C(44.6°F) DB / 6°C(42.8°F) WB
 - Piping Length : Interconnected Pipe Length = 7.5m
 - Height difference between outdoor unit and indoor unit : 0m
 2. The Maximum combination ratio is 130%.
 3. Wiring cable size must comply with the applicable local and national codes. And "Electric characteristics" chapter should be considered for electrical work and design. Especially the power cable and circuit breaker should be selected in accordance with that.
 4. Sound Level Values are measured at Anechoic chamber. Therefore, these values can be increased owing to ambient conditions during operation.
 5. Power factor could vary less than ±1% according to the operating conditions.
 6. Due to our policy of innovation some specifications may be changed without notification.

MULTI V S

TROPICAL MODEL

HEAT PUMP

ARUN080LSH0 / ARUN100LSH0



HP		8	10	
Model Name	Independent Unit	ARUN080LSH0	ARUN100LSH0	
Capacity (Rated)	*Cooling - T1 35°C	RT	6.4	8.0
		kW	22.4	28.0
	**Cooling - T3 46°C	Btu/h	76,400	95,900
		RT	5.4	7.1
	Heating	kW	19.0	25.0
		Btu/h	64,900	85,300
Input (Rated)	*Cooling - T1 35°C	RT	7.2	9.0
		kW	25.2	31.5
	**Cooling - T3 46°C	Btu/h	86,000	107,500
		kW	5.60	7.09
	Heating	kW	5.94	7.94
		Btu/h	5.86	7.41
COP	*Cooling - T1 35°C	kW / kW	4.00	3.95
	**Cooling - T3 46°C	kW / kW	3.20	3.15
	Heating	kW / kW	4.30	4.25
Power Factor	Rated	-	0.93	0.93
Casing Color		Warm Gray	Warm Gray	
Heat Exchanger		Wide Louver Plus	Wide Louver Plus	
Compressor	Type	Hermetically Sealed Scroll	Hermetically Sealed Scroll	
	Piston Displacement	cm ³ /rev	62.1	62.1
	Number of Revolution	rev/min	3,600	3,600
	Motor Output x Number	W x No.	5,300 x 1	5,300 x 1
	Starting Method		Inverter	Inverter
	Oil Type		FVC68D (PVE)	FVC68D (PVE)
Fan	Type	Propeller fan	Propeller fan	
	Motor Output x Number	W	250 x 2	251 x 2
	Air Flow Rate (High)	m ³ /min	190	190
		ft ³ /min	6,707	6,707
	Drive		DC INVERTER	DC INVERTER
	Discharge	Side / Top	Side	Side
Piping Connections	Liquid	mm (inch)	Ø9.52 (3/8)	Ø9.52 (3/8)
	Gas	mm (inch)	Ø19.05 (3/4)	Ø22.2 (7/8)
Dimensions (W x H x D)	mm		(1,090 x 1,625 x 380)	(1,090 x 1,625 x 380)
	inch		(42.9 x 64.0 x 15.0)	(42.9 x 64.0 x 15.0)
Net Weight	kg		144	144
	lbs		317	317
Sound Press Level	Cooling	dB(A)	57.0	58.0
	Heating	dB(A)	57.0	58.0
Sound Power Level		dB(A)	68	69
Communication Cable	No. x mm ² (VCTF-SB)		2C x 1.0 - 1.5	2C x 1.0 - 1.5
Refrigerant	Refrigerant name		R410A	R410A
	Precharged Amount	kg	4.5	4.5
		lbs	9.9	9.9
Power Supply	Control		Electronic Expansion Valve	Electronic Expansion Valve
		Ø, V, Hz		3, 380 - 415, 50
Number of Maximum Connectable Indoor Units			3, 400, 60	3, 400, 60
			13	16

- Note : 1. Capacities are based on the following conditions (ISO 15042)
- Cooling Temperature : *Cooling (T1) : Indoor Temperature 27°C(80.6°F) DB/19°C(66.2°F) WB / Outdoor Temperature 35°C(95°F) DB/24°C(75.2°F)
 - Heating Temperature : **Cooling (T3) : Indoor Temperature 29°C(84.2°F) DB/19°C(66.2°F) WB / Outdoor Temperature 46°C(114.8°F) DB/24°C(75.2°F) WB
 - Piping Length : Interconnected Pipe Length = 7.5m
 - Height difference between outdoor unit and indoor unit : 0m
2. The Maximum combination ratio is 130%.
3. Wiring cable size must comply with the applicable local and national codes. And "Electric characteristics" chapter should be considered for electrical work and design. Especially the power cable and circuit breaker should be selected in accordance with that.
4. Sound Level Values are measured at Anechoic chamber. Therefore, these values can be increased owing to ambient conditions during operation.
5. Power factor could vary less than ±1% according to the operating conditions.
6. Due to our policy of innovation some specifications may be changed without notification.

MULTI V S APPLICATION GUIDE

System Diagram

Providing a total solution by heat pump, air conditioning (cooling by refrigerant & chilled water, heating by refrigerant & hot water) and domestic hot water supply.

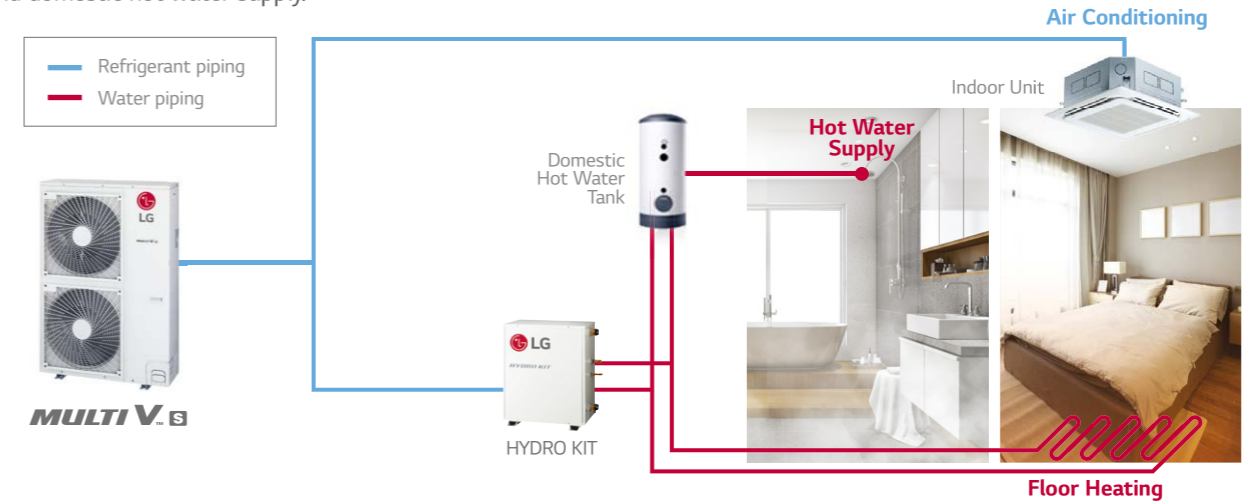

Energy Saving

Energy consumption can be reduced since absorbed heat from indoor space is used for supplying hot water.

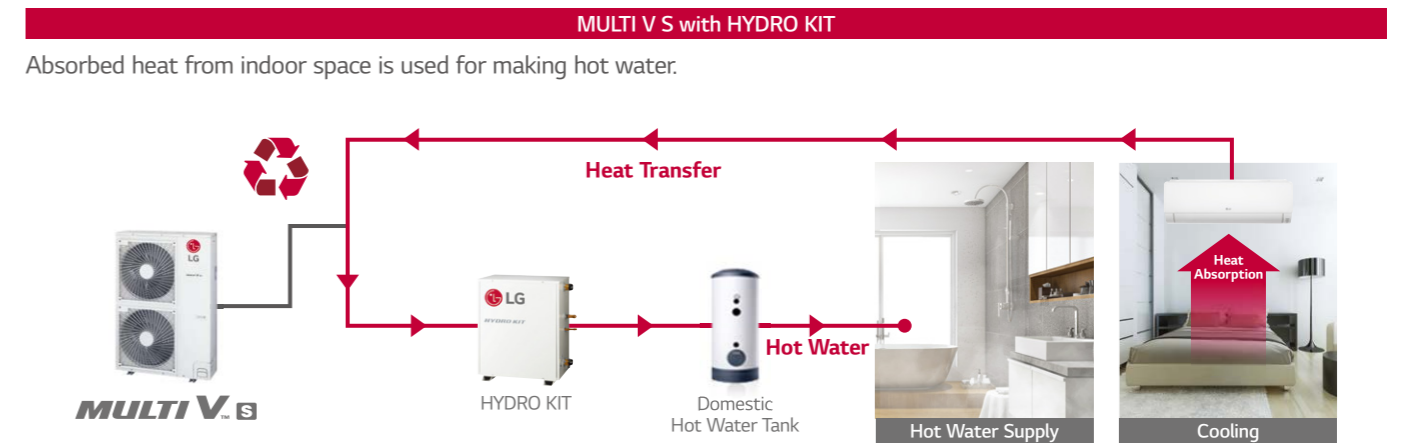
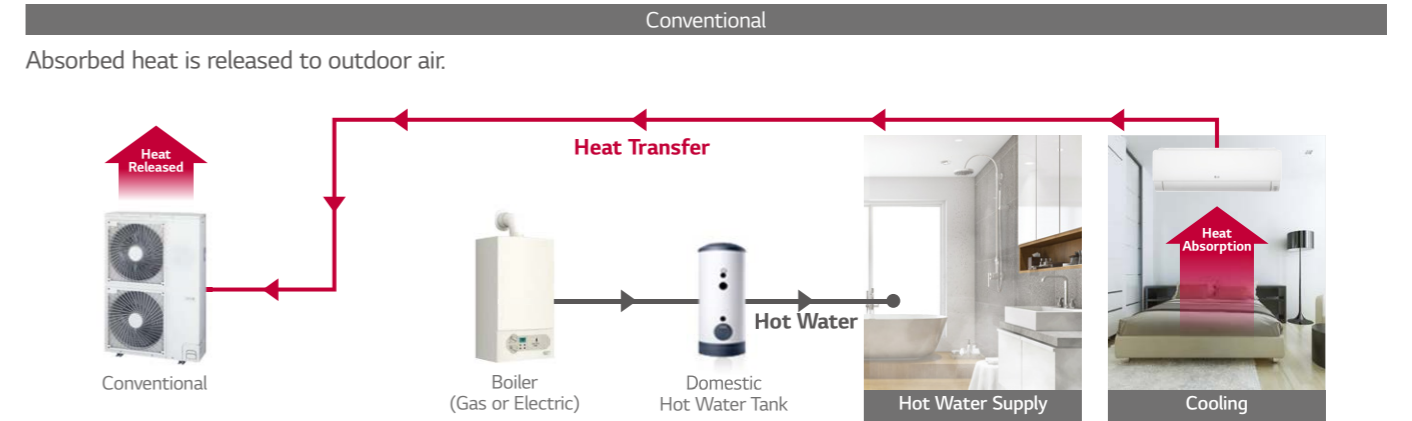



Space-Efficient modular type VRF

MULTI V™ M



Customer Benefits

- Flexible design & installation
- Space & installation cost saving
- Easy maintenance
- Building permit could be simplified

MULTI V MODULAR

Bird's-Eye View

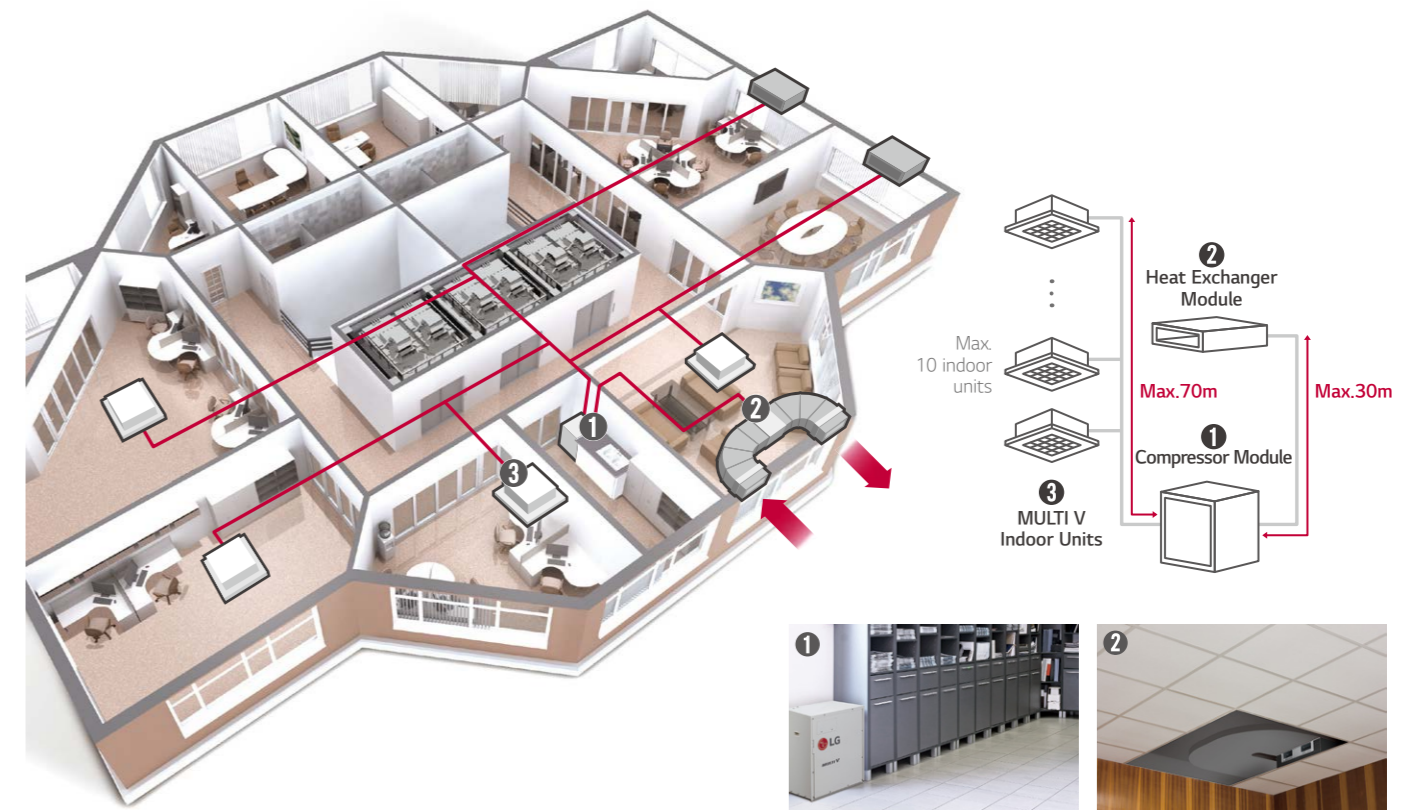

High Flexibility of Installation

Outdoor unit split by compressor and heat exchanger module

Split unit can make installation much more flexible. Compressor module can be installed at any place inside such as storage room, or in a kitchen. Heat exchanger module can be installed in a false ceiling spaces in both case of direct inlet/outlet and ducted inlet / outlet. Higher maximum external static pressure can make Installation more flexible.

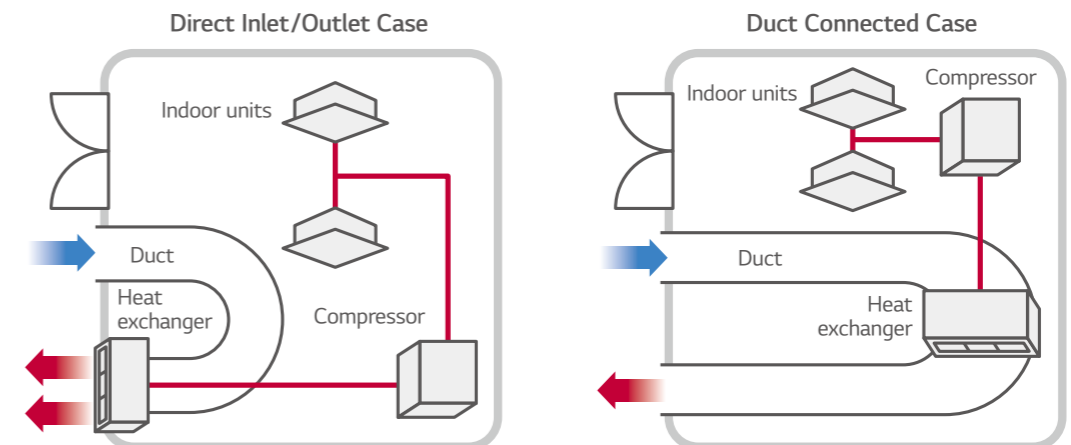

Lighter & smaller units can make installation much more easier

Ease and flexibility of installation

Ease and flexibility of installation thanks to the high static pressure available and adjustable and the reduced weight.

Small size

Make the most of your local space thanks to its small size.

Regulatory compliance

Regulatory compliance thanks to the 3,600 CMM of exhausted air.

MULTI V MODULAR

Increased Freedom of Design

Additional structure installation or ceiling construction isn't required due to improved freedom of design. This makes replacement of the compressor easier, making the service and maintenance of products handy. Moreover, split module provides low noise operation in comparison to the integrated type.



Heat exchanger module can be installed in false ceiling spaces.

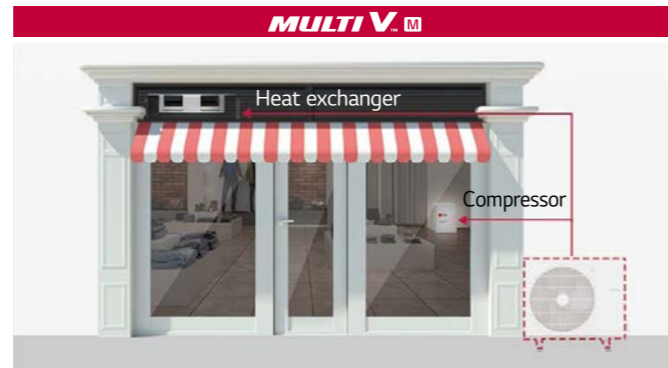

Compressor module can be installed at any place inside.



Space Saving & Convenient Installation

Volume (Compressor Module)

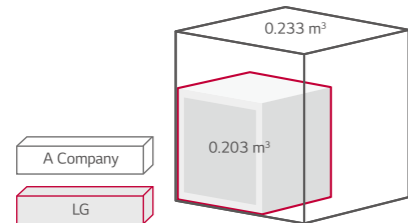

Volume (Heat Exchanger Module)

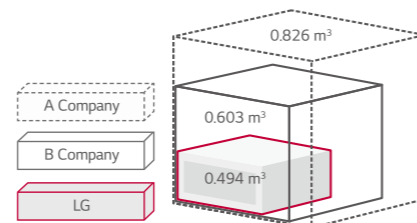

E.S.P. (External Static Pressure) Control

Normal Mode

up to 30 Pa



High Static Pressure Mode

up to 157 Pa (Max.)



Wide Louver Plus Fin + Corrosion Resistance

Wide Louver Plus fin technology increases efficiency and heating performance compared to conventional fin.

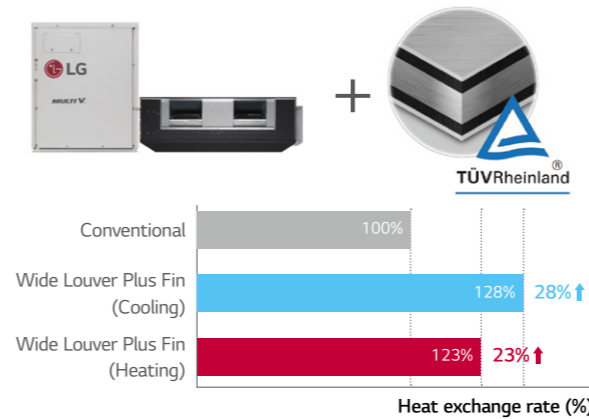

Flexible Piping Location

Neat & easy installation by flexible piping location piping.

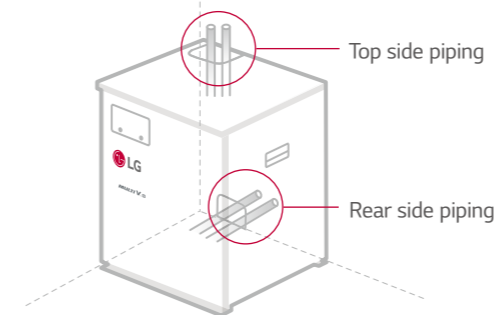

New Type Scroll

MULTI V M ensures world's best class energy efficiency with innovative technology including the LG's New Type Scroll compressor.

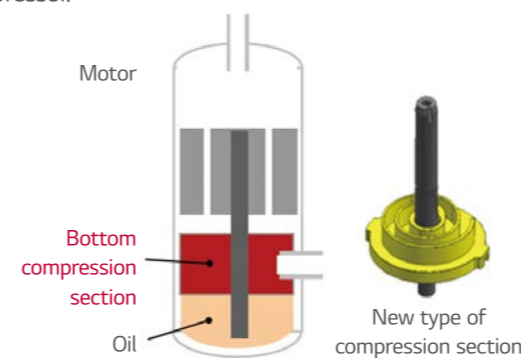

Module Type

Increased freedom of design
 - Additional structure installation and ceiling construction isn't required.
 Ease of service (Replacement of the comp.)
 Low noise by module (vs Integrated Type)

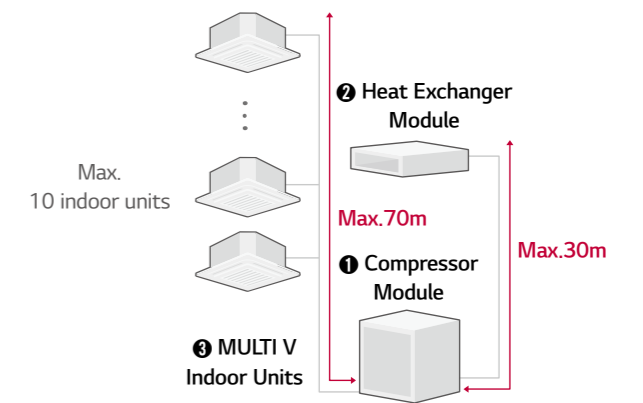

Flexible Piping Location

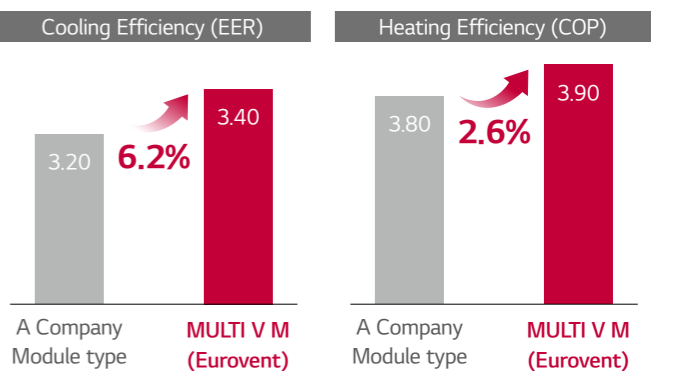

Smart Load Control

To save operation energy, automatically control the refrigerant temperature according to outdoor temperature.

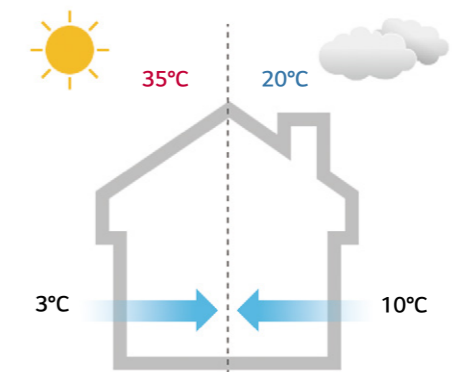

MULTI V MODULAR



※ Below spec can be revised until PDB distributed.

HP		5	
Model Name	Combination Unit	Compressor Module	
Capacity	Cooling (Rated)	kW	14.0
		kcal/h	12,000
	Heating (Rated / Max.)	kW	14.0 / 16.0
		kcal/h	12,000 / 13,800
Input (Rated)	Cooling (Rated)	kW	4.12
	Heating (Rated / Max.)	kW	3.59 / 4.32
EER (Based on Rated capacity)			3.40
COP (Based on Rated capacity)			3.90
COP (Based on Max. capacity)			3.70
Power Factor	Rated	-	0.93
Casing Color			Morning Gray
Heat Exchanger			-
Compressor	Type		Hermetic Motor Compressor
	Piston Displacement	cm ³ /rev	31.6
	Number of Revolution	rev/min	3,600
	Motor Output	W	3,200
	Starting Method		DC Inverter Starting
	Oil Type		FVC68D (PVE)
	Oil Charge		1,000
Fan	Type		-
	Motor Output x Number	W	-
	Air Flow Rate (High)	m ³ /min	-
		ft ³ /min	-
	Drive		-
External Static Pressure	Nominal (Rated, Factory Set)	mmAq (Pa)	-
	Max.	mmAq (Pa)	-
Pipe Connections	Liquid / Gas	mm (inch)	Ø9.52 (3/8) - IDU / Ø15.88 (5/8) - IDU
Dimensions (W x H x D)		mm	580 x 700 x 500
		inch	22-27/32 x 27-9/16 x 19-11/16
Net Weight		kg	69
		lbs	152
Sound Pressure Level	Cooling / Heating	dB(A)	45 / 45
Protection Devices	High Pressure Protection		High pressure sensor
	Compressor / Fan		Over-heat protection
	Inverter		Over-heat protection / Over-current protection
Communication Cable	No. x mm ² (VCTF)		2C x 1.0 - 1.5
Refrigerant	Refrigerant Name		R410A
	Precharged Amount	kg	2.0
		lbs	4.4
	t-CO ₂ eq		4.2
Control			-
Power Supply		Ø, V, Hz	3, 380 - 415, 50
Number of Maximum Connectable Indoor Units			10

- Note : 1. Eurovent Test Condition : Type of indoor unit connected is only Ceiling Concealed Duct.
 - Refer to EUROVENT certification programme for more detail test conditions.
 - Refer to EUROVENT website for test values connected Ceiling Cassette type indoors.
 2. Performances are based on the following conditions :
 - Cooling Temperature : Indoor 27°C (80.6°F) DB / 19°C (66.2°F) WB, Outdoor 35°C (95°F) DB / 24°C (75.2°F) WB
 - Heating Temperature : Indoor 20°C (68°F) DB / 15°C (59°F) WB, Outdoor 7°C (44.6°F) DB / 6°C (42.8°F) WB
 - Heat Exchanger Module - Compressor Module = 5m
 - Compressor Module - Indoor Unit = 7.5m
 3. The maximum combination ratio is 130%.
 4. Wiring cable size must comply with the applicable local and national codes.
 5. Due to our policy of innovation some specifications may be changed without notification.
 6. Sound Level Values are measured at Anechoic chamber. Therefore, these values can be increased owing to ambient conditions during operation.
 7. Power factor could vary less than ±1% according to the operating conditions.
 8. This product contains Fluorinated greenhouse gases. (R410A, GWP (Global warming potential) = 2087.5)



※ Below spec can be revised until PDB distributed.

HP		5	
Model Name	Combination Unit	Heat Exchanger Module	
Capacity	Cooling (Rated)	kW	-
		kcal/h	-
	Heating (Rated / Max.)	kW	- / -
		kcal/h	- / -
Input (Rated)	Cooling (Rated)	kW	-
	Heating (Rated / Max.)	kW	- / -
EER (Based on Rated capacity)			-
COP (Based on Rated capacity)			-
COP (Based on Max. capacity)			-
Power Factor	Rated	-	-
Casing Color			Galvanized Steel Plate
Heat Exchanger			Ocean Black Fin (Wide Louver Plus)
Compressor	Type		-
	Piston Displacement	cm ³ /rev	-
	Number of Revolution	rev/min	-
	Motor Output	W	-
	Starting Method		-
	Oil Type		-
	Oil Charge		-
Fan	Type		Sirocco Fan
	Motor Output x Number	W	400 x 2
	Air Flow Rate (High)	m ³ /min	60
		ft ³ /min	2,119
	Drive		Direct
External Static Pressure	Nominal (Rated, Factory Set)	mmAq (Pa)	3 (29)
	Max.	mmAq (Pa)	16 (157)
Pipe Connections	Liquid / Gas	mm (inch)	Ø12.7 (1/2) - Comp. Module / Ø19.05 (3/4) - Comp. Module
Dimensions (W x H x D)		mm	1,562 x 460 x 688
		inch	61-1/2 x 18-1/8 x 27-3/32
Net Weight		kg	84
		lbs	185
Sound Pressure Level	Cooling / Heating	dB(A)	45 / 45
Protection Devices	High Pressure Protection		-
	Compressor / Fan		Fan driver overload protector
	Inverter		-
Communication Cable	No. x mm ² (VCTF)		2C x 1.0 - 1.5
Refrigerant	Refrigerant Name		-
	Precharged Amount	kg	-
		lbs	-
	t-CO ₂ eq		-
Control			Electronic Expansion Valve
Power Supply		Ø, V, Hz	1, 220 - 240, 50
Number of Maximum Connectable Indoor Units			-

- Note : 1. Eurovent Test Condition : Type of indoor unit connected is only Ceiling Concealed Duct.
 - Refer to EUROVENT certification programme for more detail test conditions.
 - Refer to EUROVENT website for test values connected Ceiling Cassette type indoors.
 2. Performances are based on the following conditions :
 - Cooling Temperature : Indoor 27°C (80.6°F) DB / 19°C (66.2°F) WB, Outdoor 35°C (95°F) DB / 24°C (75.2°F) WB
 - Heating Temperature : Indoor 20°C (68°F) DB / 15°C (59°F) WB, Outdoor 7°C (44.6°F) DB / 6°C (42.8°F) WB
 - Heat Exchanger Module - Compressor Module = 5m
 - Compressor Module - Indoor Unit = 7.5m
 3. The maximum combination ratio is 130%.
 4. Wiring cable size must comply with the applicable local and national codes.
 5. Due to our policy of innovation some specifications may be changed without notification.
 6. Sound Level Values are measured at Anechoic chamber. Therefore, these values can be increased owing to ambient conditions during operation.
 7. Power factor could vary less than ±1% according to the operating conditions.
 8. This product contains Fluorinated greenhouse gases. (R410A, GWP (Global warming potential) = 2087.5)



Highly efficient & Economical water source system

MULTI VTM WATER IV



Customer Benefits

- Operation independent of weather conditions
- Utilizing renewable source
- Replacement of Chiller-FCU system

VARIABLE WATER FLOW CONTROL

Buildings Made Eco-Friendly

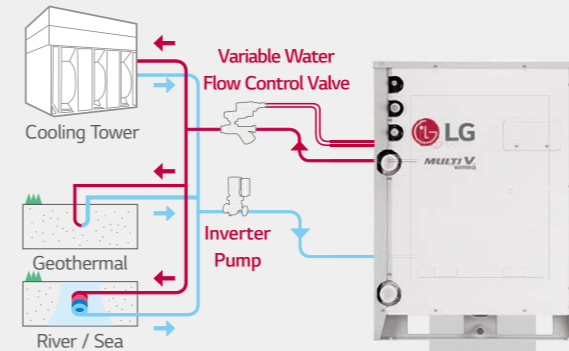

Energy Consumption **71%**

LG applied Variable Water Flow Control to optimize water flow control regarding partial cooling or heating load conditions.

HiPORTM

Maximizes Reliability and Efficiency of the Compressor

33%
Efficiency

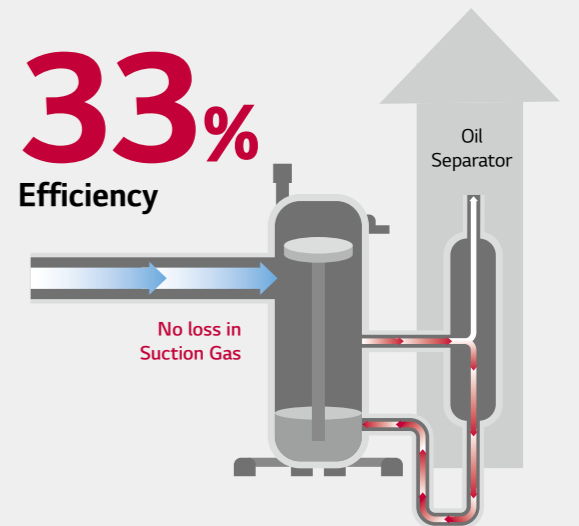

HiPORTM technology enables oil to return directly into the compressor, instead of returning through the refrigerant suction pipe. This does not waste energy when oil flows between the separator and the compressor.

LONGEST PIPING LENGTH

Design and Installation of Immense Variety of Building



Provide flexible installation up to 300m of total piping length. As water pipes are not connected to indoor units, users are free from water leakage problems.

COMPACT SIZE & LIGHT WEIGHT

Easy and Unrestricted Installation with Reduced Size and Weight

Reduced size **61%** Reduced weight **18%**
Double Stacking



LG applied Variable Water Flow Control to optimize water flow control regarding partial cooling or heating load conditions.

MULTI V WATER IV

Piping Length

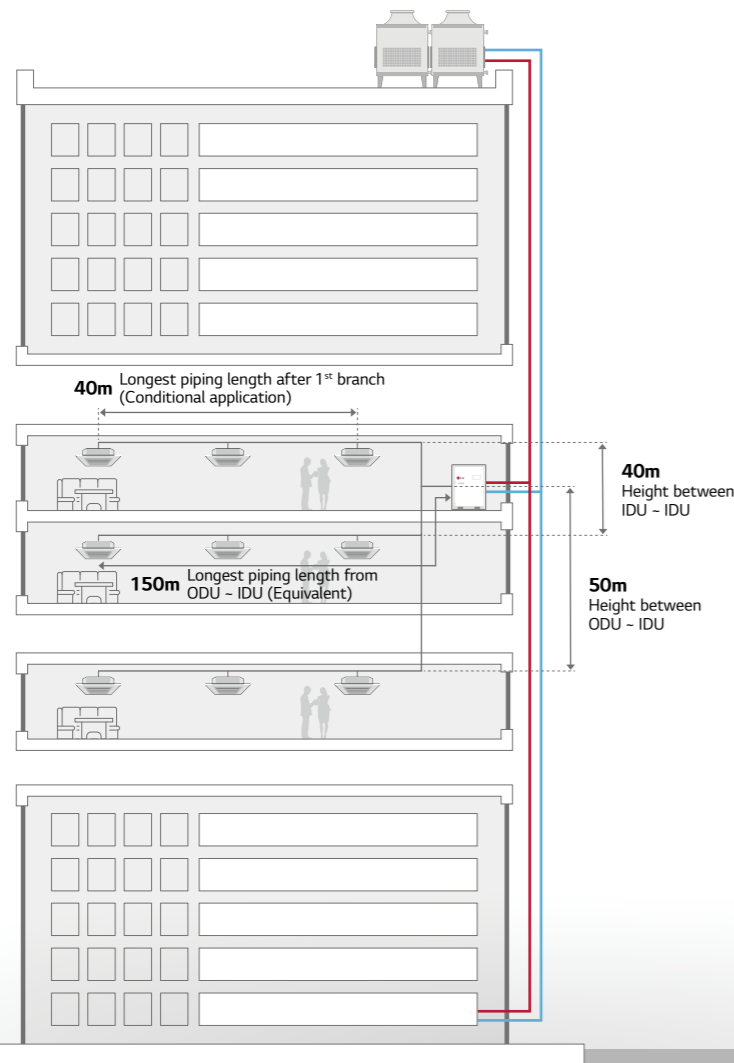

Total Piping Length	300m
Longest piping length from ODU - IDU (Equivalent)	150m (175m)
Longest piping length after 1 st branch (Conditional application)	40m (90m)
Height between ODU - IDU	50m
Height between IDU - ODU	40m

High Efficiency System Regardless of External Conditions

Regardless of outdoor temperature and other environmental conditions, MULTI V WATER IV is the optimal solution.

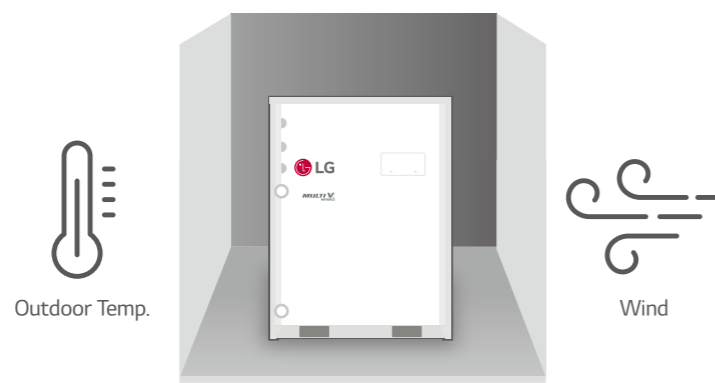

MULTI V WATER IV System for Geothermal Applications

Uses underground heat sources such as soil, ground water, lake, river, etc. as renewable energy for cooling and Heating of a building. Water or antifreeze solution is circulated through the closed loop HDPE (High Density Poly-Ethylene) pipes buried beneath the earth's surface. It is a highly efficient and eco-friendly MULTI V system.

- The Circulating water temperature range is between -5°C - 45°C
- Antifreeze should be applied depending on the application.

※ Please contact local LG office for application availability.

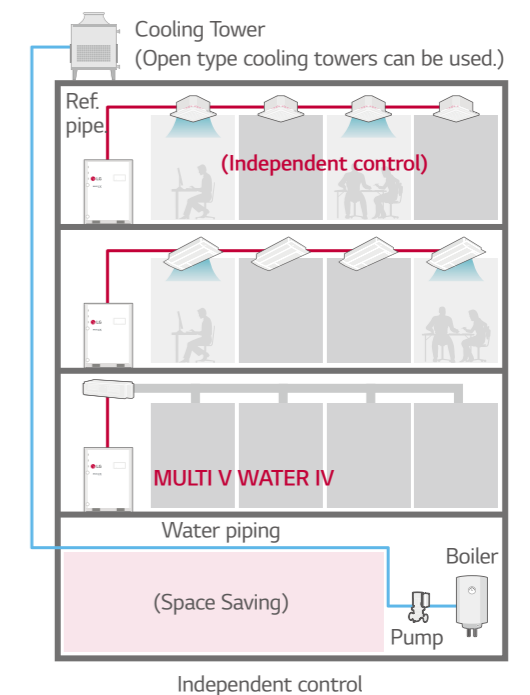
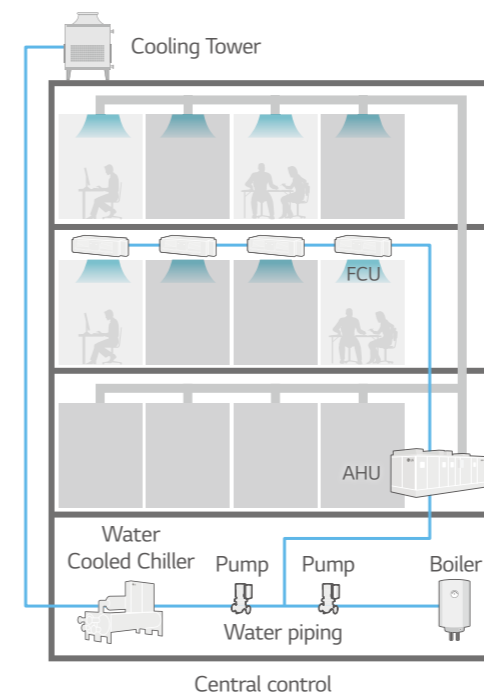
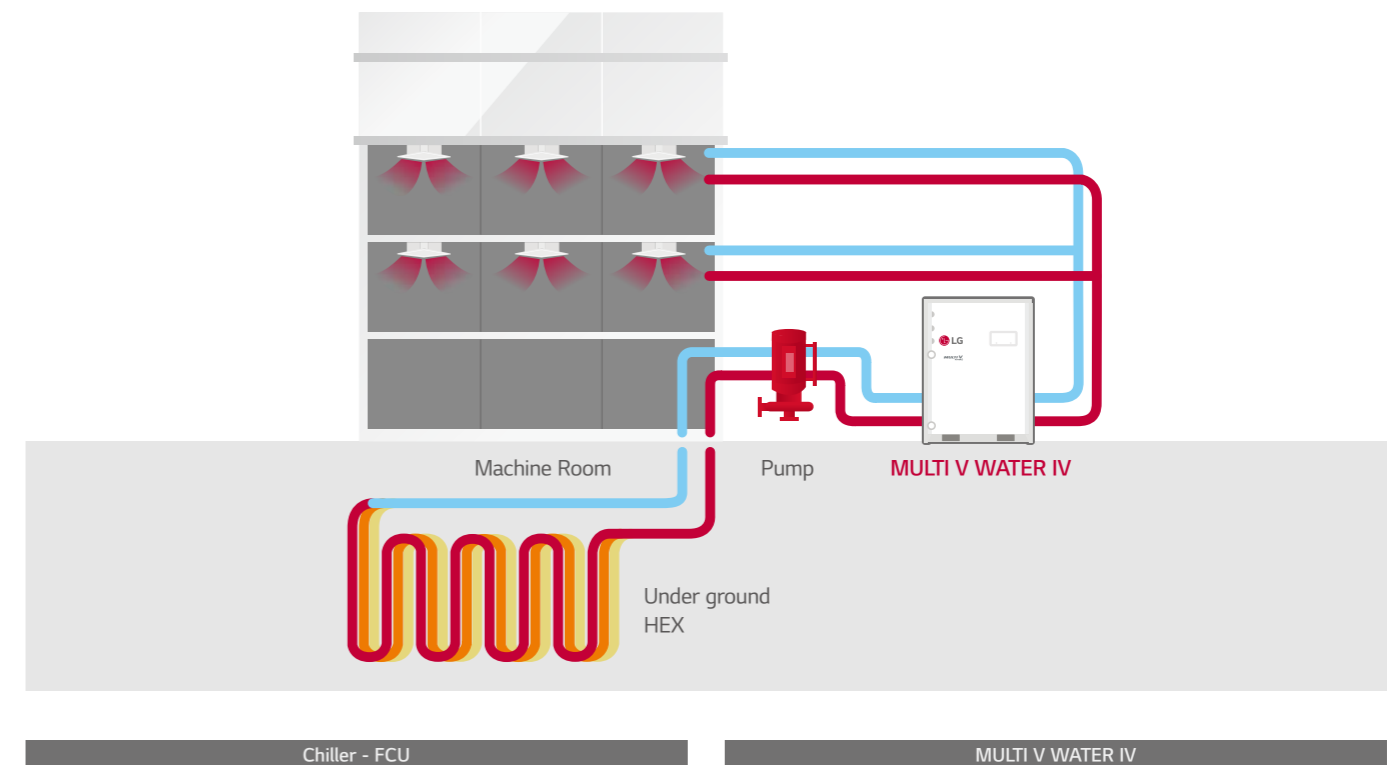

MULTI V WATER IV

Economical, Highly Efficient System

LG's key technologies are integrated to inverter compressor

Adopting a water-based cooling method, this unit optimizes performance in comparison to compressor capacity. It also ensures heat exchange performance for high-rise buildings, thus allowing electrical-savings.



Maximum COP

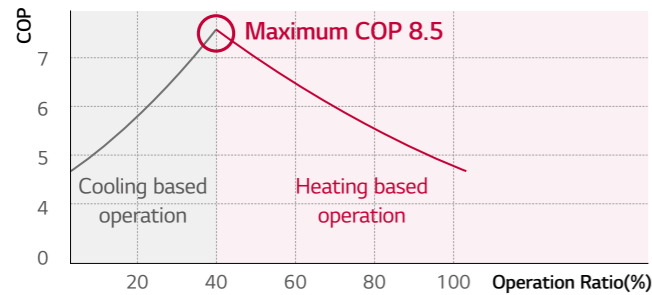

※ Outdoor unit water inlet temperature : 7°C
 ※ Indoor temperature : 20°C DB / 15°C WB
 ※ Maximum COP Condition : Cooling 40% + Heating 60% operation

Economical, Highly Efficient System

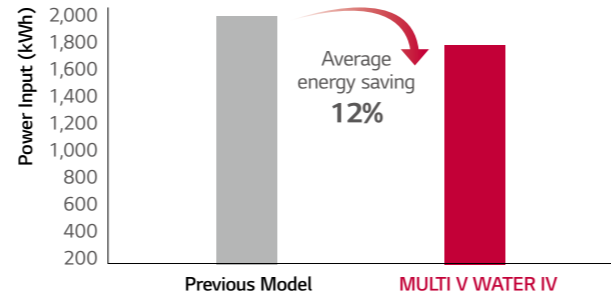

LG's 4th Generation Inverter Compressor

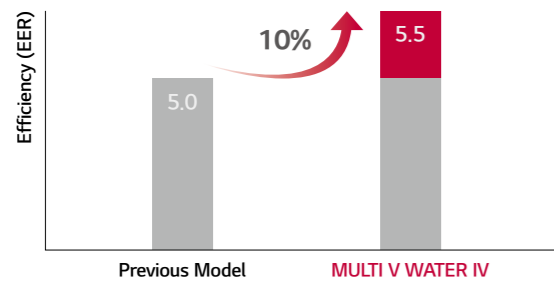

- 5% HEX Optimization
- 2% Cycle Composition Improvement
- 1% Inverter Control
- 1% Active Oil Control
- 1% HiPOR™

※ Comparison between 10HP in cooling mode

Integrated Part Load Efficiency

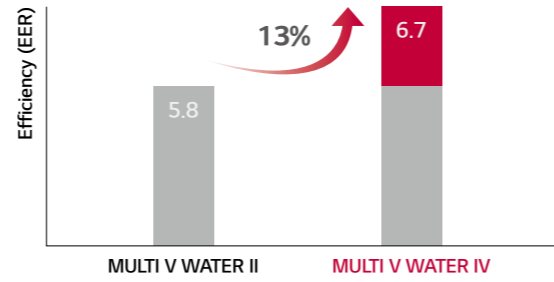

- 6% HEX Optimization
- 4% Cycle Composition Improvement
- 1% Inverter Control
- 1% Active Oil Control
- 1% HiPOR™

Variable Water Flow Control (Option)

Supporting your buildings to become greener

The world's first variable water flow control system for water cooled VRF system. LG applied Variable Water Flow Control to optimize water flow control regarding partial cooling or heating load conditions. Because of this it's also possible to reduce circulation pump energy consumption.

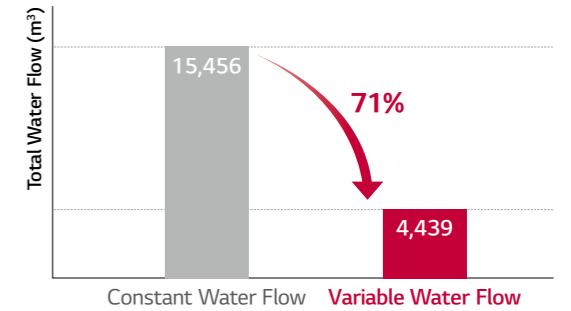
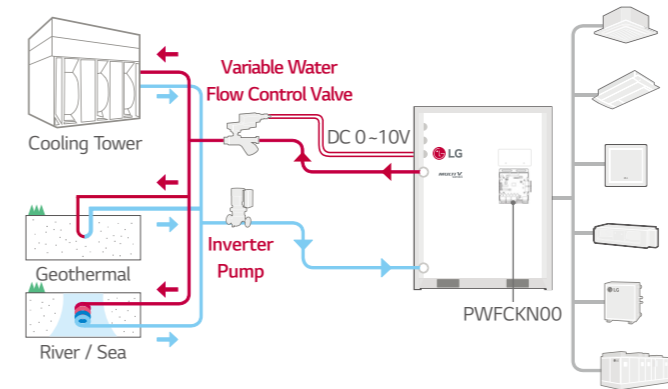

Note : 1. Location : Paris, France
 2. Office, 68,000m²
 3. Operation time: 1,344 hours (cooling period)

Project Example : 63F (Pump : 20,064 LPM, 42.4mAq x 4ea)

- 1) Inverter pump with MULTI V WATER and variable water flow control kit.
- 2) Constant pump (Step control) with Water cooled VRF.

10 years energy cost (\$)

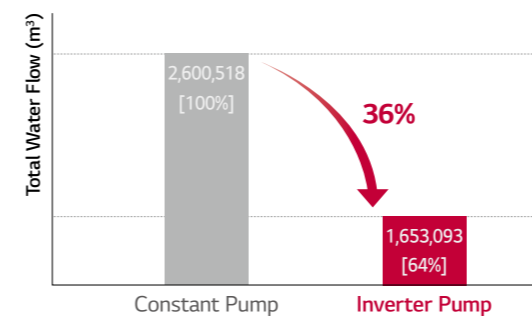

Unit	5 years		10 years	
	Energy Use (kWh)	Pump Running Cost (\$)	Energy Use (kWh)	Pump Running Cost (\$)
Constant pump	7,952,040	1,142,441	15,904,080	2,600,518
Inverter pump	5,054,940	726,225	10,109,880	1,653,093

- Power consumption rate : 0.13\$/kWh
- Annual power consumption rate expected to increase by 5%

Largest Capacity

World's largest capacity makes it easy to apply to large building and large systems

Providing 8 ~ 20HP (22.4 ~ 56kW) with single unit, and up to the world's largest capacity 80HP (224kW) by combination.

HP	8	10	14	20	22	24	28	30	34	40	42 ~ 60	62 ~ 80
kW	22.4	28	39.2	56	61.6	67.2	78.4	84	95.2	112	117.6 ~ 168	173.6 ~ 224
LG	1 Unit				2 Units				3 Units		4 Units	

MULTI V WATER IV

Longest Piping Length

Sufficient pipes length limitation in Design and Installation of immense variety of building

Provide flexible installation up to 300m of total piping length. As water pipes are not connected to indoor units, users are free from water leakage problems.

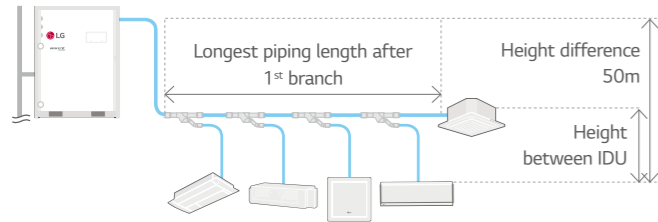

Total piping length	300m
Actual longest piping length (Equivalent)	150m (175m)
Longest piping length after 1 st branch (Conditional application)	40m (90m)
Height difference between ODU - IDU	50m
Height difference between IDU - IDU	40m

Compact Size

Significant uptake of construction space that can be used for commercial use or public space as much as possible

The optimal design of the compact, lightweight outdoor unit enables double stacking, which results in 50% savings in installation space.

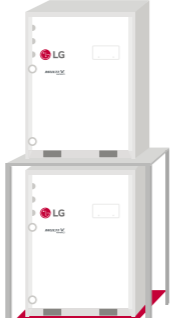
Company B	MULTI V WATER IV
 <p>28kW x 4EA Per Each 880 x 550 mm</p>	 <div style="border: 1px solid black; border-radius: 50%; width: 40px; height: 40px; display: flex; align-items: center; justify-content: center; margin: 0 auto;"> <div style="text-align: center;"> <p>61% Reduced</p> </div> </div> <p>56kW x 2EA Per Each 755 x 500 mm</p>

※ 112kW, Floor area based

Light Weight

Nothing or Decrease additional load reinforcement work at building

Easier to transport and install thanks to 15% reduction in overall weight.

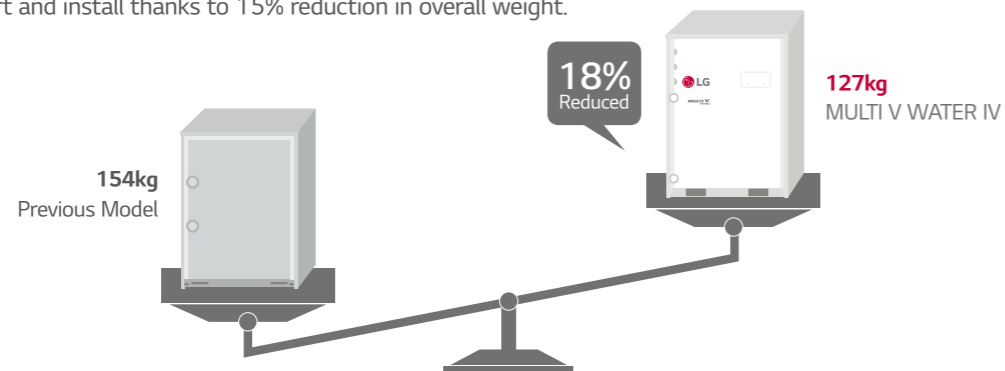

※ Based on 28kW

MULTI V WATER IV

Precaution of Installation

1. Do not install the unit at the outdoors. (Otherwise it may cause fire, electric shock and trouble.) Recommended ambient temperature of outdoor unit is between 0 ~ 40°C.
2. Keep the water temperature between **10 ~ 45°C**. Other it may cause the breakdown. Standard water supply temperature is 30°C for Cooling and 20°C for heating.
3. Establish an **anti-freeze plan** for the water supply when the product is stopped during the winter.
4. Be careful of the **water purity control**. Otherwise it may cause the breakdown due to water pipe corrosion. (Refer to 'Standard Table for Water Purity Control')
5. The water pressure resistance of the water pipe system of this product is **1.98MPa**.
6. Always install a **trap** so that the drained water does not back flush.
7. Install a **pressure gauge and temperature gauge** at the inlet and outlet of the water pipe.
8. **Flexible joints** must be installed not to cause any leakage from the vibration of pipes.
9. Install a **service port** to clean the heat exchanger at the each end of the water inlet and outlet.
10. It is recommended to install the **flow switch** to the water collection pipe system connecting to the outdoor unit. (Flow switch acts as the 1st protection device when the heat water is not supplied.)
11. When setting the flow switch, it is recommended to use the product with default set value to satisfy the minimum flow rate of this product. (The minimum flow rate range of this product is **50%**.)
12. To protect the water cooling type product, you must install a **strainer with 50 mesh** or more on the heat water supply pipe. If not installed, it can result in damage of heat exchanger by the following situation.
 - 1) Heat water supply within the plate type heat exchanger is composed of multiple small paths.
 - 2) If you do not use a strainer with 50 mesh or more, alien particles can partially block the water paths.
 - 3) When running the heater, the plate type heat exchanger plays the role of the evaporator, and at this time, the temperature of the refrigerant side drops to drop the temperature of the heat water supply, which can result in icing point in the water paths.
 - 4) And as the heating process progresses, the water paths can be partially frozen to lead to damage in plate type heat exchanger.
 - 5) As a result of the damage of the heat exchanger from the freezing, the refrigerant side and the heat water source side will be mixed to make the product unusable.

MULTI V WATER IV REFERENCE SITE

Bouygues Challenger

LG MULTI V WATER Solution with Geothermal Application.



Site Information

The industrial group Bouygues was established in France in 1952. It now maintains operations in 80 countries and employs more than 131,000 people. In 1988, after two years of construction, the new headquarters for Bouygues Construction was officially opened for business. Named Challenger, the complex became a technological showcase for late 20th century architecture.

LG Solution

Bouygues decided to convert their headquarters into an eco-friendly building by significantly reducing its energy footprint. The LG MULTI V Water system was chosen as the ideal HVAC solution for this project. The system not only saves energy but also reduces water usage as it recycles water in order to regulate the temperature of the building. With LG's advanced technology, the building's water consumption was reduced by more than 70 percent.

MULTI V WATER IV

HEAT PUMP

ARWN080LAS4 / ARWN100LAS4 / ARWN140LAS4 / ARWN200LAS4



HP			8	10	14	20
Model Name	Combination Unit		ARWN080LAS4	ARWN100LAS4	ARWN140LAS4	ARWN200LAS4
	Independent Unit		ARWN080LAS4	ARWN100LAS4	ARWN140LAS4	ARWN200LAS4
Capacity	Cooling	kW	22.4	28.0	39.2	56.0
	Heating	kW	25.2	31.5	44.1	63.0
Input	Cooling	kW	3.86	5.09	7.84	11.20
	Heating	kW	4.20	5.34	8.17	11.67
Casing Color			Warm Gray, Mornig Gray	Warm Gray, Mornig Gray	Warm Gray, Mornig Gray	Warm Gray, Mornig Gray
Compressor	Type		Hermetically Sealed Scroll	Hermetically Sealed Scroll	Hermetically Sealed Scroll	Hermetically Sealed Scroll
	Combination		(Inverter) x 1	(Inverter) x 1	(Inverter) x 1	(Inverter) x 1
	Piston Displacement	cm ³ /rev	43.8	43.8	43.8	62.1
	Number of revolution	rev/min	Inverter 3,600 at 60Hz	Inverter 3,600 at 60Hz	Inverter 3,600 at 60Hz	Inverter 3,600 at 60Hz
	Motor Output	kW	4.2	4.2	4.2	5.3
	Starting Method		Direct On Line	Direct On Line	Direct On Line	Direct On Line
	Oil Type		FVC68D (PVE)	FVC68D (PVE)	FVC68D (PVE)	FVC68D (PVE)
	Oil Charge Amount	cc	1,200 + 1,600	1,200 + 1,600	1,200 + 1,600	1,400 + 1,600
Heat Exchanger	Type		Stainless Steel Plate	Stainless Steel Plate	Stainless Steel Plate	Stainless Steel Plate
	Maximum Pressure Resistance	kgf/cm ²	45	45	45	45
	Head Loss	kPa	10.7	15.8	28.6	30.1
	Rated Water Flow	LPM	77	96	135	192
Temp. range of	Cooling		10°C - 45°C (50°F - 113°F)	10°C - 45°C (50°F - 113°F)	10°C - 45°C (50°F - 113°F)	10°C - 45°C (50°F - 113°F)
Circulation water	Heating		-5°C - 45°C (23°F - 113°F)	-5°C - 45°C (23°F - 113°F)	5°C - 45°C (23°F - 113°F)	-5°C - 45°C (23°F - 113°F)
Refrigerant Connecting Pipes	Liquid Pipes	mm (inch)	9.52 (3/8)	9.52 (3/8)	12.7 (1/2)	12.7 (1/2)
	Gas Pipes	mm (inch)	22.2 (7/8)	22.2 (7/8)	25.4 (1)	28.58 (1-1/8)
Water Connecting Pipes	Inlet	mm	PT40 (1-1/2, Internal)	PT40 (1-1/2, Internal)	PT40 (1-1/2, Internal)	PT40 (1-1/2, Internal)
	Outlet	mm	PT40 (1-1/2, Internal)	PT40 (1-1/2, Internal)	PT40 (1-1/2, Internal)	PT40 (1-1/2, Internal)
	Drain Outlet	mm	PT20 (3/4, External)	PT20 (3/4, External)	PT20 (3/4, External)	PT20 (3/4, External)
Dimensions (W x H x D)	mm		(755 x 500 x 997) x 1	(755 x 500 x 997) x 1	(755 x 500 x 997) x 1	(755 x 500 x 997) x 1
	inch		(29-23/32 x 39-1/4 x 19-11/16) x 1	(29-23/32 x 39-1/4 x 19-11/16) x 1	(29-23/32 x 39-1/4 x 19-11/16) x 1	(29-23/32 x 39-1/4 x 19-11/16) x 1
Net Weight	kg		127 x 1	127 x 1	127 x 1	140 x 1
	lbs		280 x 1	280 x 1	280 x 1	309 x 1
Transmission Cable (CVV-SB)		mm ²	1.0 - 1.5 x 2C	1.0 - 1.5 x 2C	1.0 - 1.5 x 2C	1.0 - 1.5 x 2C
Refrigerant	Name		R410A	R410A	R412A	R410A
	Charge Amount	kg	5.8	5.8	5.8	5.8
	Control Device		EEV	EEV	EEV	EEV
Power Supply		∅, V, Hz	3, 380 - 415, 50	3, 380 - 415, 50	3, 380 - 415, 50	3, 380 - 415, 50
			3, 380, 60	3, 380, 60	3, 380, 60	3, 380, 60
Sound Pressure Level	Cooling	dB(A)	47	50	58	54
	Heating	dB(A)	51	53	57	60
Sound Power Level	Cooling	dB(A)	59	62	70	66
	Heating	dB(A)	63	65	69	72

※ This product contains Fluorinated Greenhouse Gases. (R410A)

Note : 1. Capacities and Inputs are based on the following conditions.

- Cooling : Indoor temp. 27°C (80.6°F) DB / 19°C (66.2°F) WB, Water inlet temp. 30°C (86°F), Interconnecting piping length 7.5m, Level difference of zero

- Heating : Indoor temp. 20°C (68°F) DB, Water inlet temp. 20°C (68°F)

2. Capacities are net capacities.

3. Due to our policy of innovation some specifications may be changed without notification.

4. Add an anti-freeze to circulation water when Outdoor unit is operating under 10°C (50°F), and change the DIP switch on main PCB. (For more information on installation section.)

HEAT PUMP

ARWN220LAS4 / ARWN240LAS4 / ARWN280LAS4 / ARWN300LAS4



HP			22	24	28	30
Model Name	Combination Unit		ARWN220LAS4	ARWN240LAS4	ARWN280LAS4	ARWN300LAS4
	Independent Unit		ARWN140LAS4 ARWN080LAS4	ARWN140LAS4 ARWN100LAS4	ARWN140LAS4 ARWN140LAS4	ARWN200LAS4 ARWN100LAS4
Capacity	Cooling	kW	61.6	67.2	78.4	84.0
	Heating	kW	69.3	75.6	88.2	94.5
Input	Cooling	kW	11.70	12.93	15.68	16.29
	Heating	kW	12.37	13.51	16.34	17.01
Casing Color			Warm Gray, Mornig Gray	Warm Gray, Mornig Gray	Warm Gray, Mornig Gray	Warm Gray, Mornig Gray
Compressor	Type		Hermetically Sealed Scroll	Hermetically Sealed Scroll	Hermetically Sealed Scroll	Hermetically Sealed Scroll
	Combination		(Inverter) x 2	(Inverter) x 2	(Inverter) x 2	(Inverter) x 2
	Piston Displacement	cm ³ /rev	43.8 + 43.8	43.8 + 43.8	43.8 + 43.8	62.1 + 43.8
	Number of revolution	rev/min	Inverter 3,600 at 60Hz	Inverter 3,600 at 60Hz	Inverter 3,600 at 60Hz	Inverter 3,600 at 60Hz
	Motor Output	kW	4.2+4.2	4.2 + 4.2	4.2 + 4.2	5.3 + 4.2
	Starting Method		Direct On Line	Direct On Line	Direct On Line	Direct On Line
	Oil Type		FVC68D (PVE)	FVC68D (PVE)	FVC68D (PVE)	FVC68D (PVE)
	Oil Charge Amount	cc	(1,200 + 1,600) x 2	(1,200 + 1,600) x 2	(1,200 + 1,600) x 2	(1,400 + 1,200) + 1,600 x 2
Heat Exchanger	Type		Stainless Steel Plate	Stainless Steel Plate	Stainless Steel Plate	Stainless Steel Plate
	Maximum Pressure Resistance	kgf/cm ²	45	45	45	45
	Head Loss	kPa	28.6 + 10.7	28.6 + 15.8	28.6 + 28.6	30.1 + 15.8
	Rated Water Flow	LPM	135 + 77	135 + 96	135 + 135	192 + 96
Temp. range of	Cooling		10°C - 45°C (50°F - 113°F)	10°C - 45°C (50°F - 113°F)	10°C - 45°C (50°F - 113°F)	10°C - 45°C (50°F - 113°F)
Circulation water	Heating		-5°C - 45°C (23°F - 113°F)	-5°C - 45°C (23°F - 113°F)	-5°C - 45°C (23°F - 113°F)	-5°C - 45°C (23°F - 113°F)
Refrigerant Connecting Pipes	Liquid Pipes	mm (inch)	19.05 (3/4)	19.05 (3/4)	19.05 (3/4)	19.05 (3/4)
	Gas Pipes	mm (inch)	34.9 (1-3/8)	34.9 (1-3/8)	34.9 (1-3/8)	34.9 (1-3/8)
Water Connecting Pipes	Inlet	mm	PT40 + PT40 (Internal)	PT40 + PT40 (Internal)	PT40 + PT40 (Internal)	PT40 + PT40 (Internal)
	Outlet	mm	PT40 + PT40 (Internal)	PT40 + PT40 (Internal)	PT40 + PT40 (Internal)	PT40 + PT40 (Internal)
	Drain Outlet	mm	PT20 (3/4, External)	PT20 (3/4, External)	PT20 (3/4, External)	PT20 (3/4, External)
Dimensions (W x H x D)	mm		(755 x 997 x 500) x 2	(755 x 997 x 500) x 2	(755 x 997 x 500) x 2	(755 x 997 x 500) x 2
	inch		(29-23/32 x 39-1/4 x 19-11/16) x 2	(29-23/32 x 39-1/4 x 19-11/16) x 2	(29-23/32 x 39-1/4 x 19-11/16) x 2	(29-23/32 x 39-1/4 x 19-11/16) x 2
Net Weight	kg		127 x 2	127 x 2	127 x 2	(140 x 1) + (127 x 1)
	lbs		280 x 2	280 x 2	280 x 2	(309 x 1) + (280 x 1)
Transmission Cable (CVV-SB)		mm ²	1.0 - 1.5 x 2C	1.0 - 1.5 x 2C	1.0 - 1.5 x 2C	1.0 - 1.5 x 2C
Refrigerant	Name		R410A	R410A	R410A	R410A
	Charge Amount	kg	5.8 + 5.8	5.8 + 5.8	5.8 + 5.8	3.0 + 5.8
	Control Device		EEV	EEV	EEV	EEV
Power Supply		∅, V, Hz	3, 380 - 415, 50	3, 380 - 415, 50	3, 380 - 415, 50	3, 380 - 415, 50
			3, 380, 60	3, 380, 60	3, 380, 60	3, 380, 60
Sound Pressure Level	Cooling	dB(A)	58	59	59	55
	Heating	dB(A)	58	58	58	61
Sound Power Level	Cooling	dB(A)	71	72	72	68
	Heating	dB(A)	71	71	71	74

※ This product contains Fluorinated Greenhouse Gases. (R410A)

Note : 1. Capacities and Inputs are based on the following conditions.

- Cooling : Indoor temp. 27°C (80.6°F) DB / 19°C (66.2°F) WB, Water inlet temp. 30°C (86°F), Interconnecting piping length 7.5m, Level difference of zero

- Heating : Indoor temp. 20°C (68°F) DB, Water inlet temp. 20°C (68°F)

2. Capacities are net capacities.

3. Due to our policy of innovation some specifications may be changed without notification.

4. Add an anti-freeze to circulation water when Outdoor unit is operating under 10°C (50°F), and change the DIP switch on main PCB. (For more information on installation section.)

MULTI V WATER IV

HEAT PUMP

ARWN340LAS4 / ARWN400LAS4 / ARWN420LAS4 / ARWN440LAS4



HP		34	40	42	44
Model Name	Combination Unit	ARWN340LAS4	ARWN400LAS4	ARWN420LAS4	ARWN440LAS4
	Independent Unit	ARWN200LAS4 ARWN140LAS4	ARWN200LAS4 ARWN200LAS4	ARWN200LAS4 ARWN140LAS4 ARWN080LAS4	ARWN200LAS4 ARWN140LAS4 ARWN100LAS4
Capacity	Cooling kW	95.2	112.0	117.6	123.2
	Heating kW	107.1	126.0	132.3	138.6
Input	Cooling kW	19.04	22.40	22.90	24.13
	Heating kW	19.84	23.34	24.04	25.18
Casing Color		Warm Gray, Mornig Gray	Warm Gray, Mornig Gray	Warm Gray, Mornig Gray	Warm Gray, Mornig Gray
Compressor	Type	Hermetically Sealed Scroll	Hermetically Sealed Scroll	Hermetically Sealed Scroll	Hermetically Sealed Scroll
	Combination	(Inverter) x 2	(Inverter) x 2	(Inverter) x 3	(Inverter) x 3
	Piston Displacement cm ³ /rev	43.8 + 62.1	62.1 + 62.1	62.1 + 43.8 + 43.8	62.1 + 43.8 + 43.8
	Number of revolution rev/min	Inverter 3,600 at 60Hz	Inverter 3,600 at 60Hz	Inverter 3,600 at 60Hz	Inverter 3,600 at 60Hz
	Motor Output kW	4.2 + 5.3	5.3 + 5.3	5.3 + 4.2 + 4.2	5.3 + 4.2 + 4.2
	Starting Method	Direct On Line	Direct On Line	Direct On Line	Direct On Line
	Oil Type	FVC68D (PVE)	FVC68D (PVE)	FVC68D (PVE)	FVC68D (PVE)
	Oil Charge Amount cc	(1,400 + 1,200) + 1,600 x 2	(1,400 + 1,600) x 2	(1,400 + 1,200 + 1,200) + 1,600 x 3	(1,400 + 1,200 + 1,200) + 1,600 x 3
Heat Exchanger	Type	Stainless Steel Plate	Stainless Steel Plate	Stainless Steel Plate	Stainless Steel Plate
	Maximum Pressure Resistance kgf/cm ²	45	45	45	45
	Head Loss kPa	30.1 + 28.6	30.1 + 30.1	30.1 + 28.6 + 10.7	30.1 + 28.6 + 15.8
	Rated Water Flow LPM	192 + 135	192 + 192	192 + 135 + 77	192 + 135 + 96
Temp. range of Circulation water	Cooling	10°C - 45°C (50°F - 113°F)	10°C - 45°C (50°F - 113°F)	10°C - 45°C (50°F - 113°F)	10°C - 45°C (50°F - 113°F)
	Heating	-5°C - 45°C (23°F - 113°F)	-5°C - 45°C (23°F - 113°F)	-5°C - 45°C (23°F - 113°F)	-5°C - 45°C (23°F - 113°F)
Refrigerant Connecting Pipes	Liquid Pipes mm (inch)	19.05 (3/4)	19.05 (3/4)	19.05 (3/4)	19.05 (3/4)
	Gas Pipes mm (inch)	34.9 (1-3/8)	41.3 (1-5/8)	41.3 (1-5/8)	41.3 (1-5/8)
Water Connecting Pipes	Inlet mm	PT40 + PT40 (Internal)	PT40 + PT40 (Internal)	PT40 + PT40 + PT40 (Internal)	PT40 + PT40 + PT40 (Internal)
	Outlet mm	PT40 + PT40 (Internal)	PT40 + PT40 (Internal)	PT40 + PT40 + PT40 (Internal)	PT40 + PT40 + PT40 (Internal)
	Drain Outlet mm	PT20 (3/4, External)	PT20 (3/4, External)	PT20 (3/4, External)	PT20 (3/4, External)
Dimensions (W x H x D)	mm	(755 x 997 x 500) x 2	(755 x 997 x 500) x 2	(755 x 997 x 500) x 3	(755 x 997 x 500) x 3
	inch	(29-23/32 x 39-1/4 x 19-11/16) x 2	(29-23/32 x 39-1/4 x 19-11/16) x 2	(29-23/32 x 39-1/4 x 19-11/16) x 3	(29-23/32 x 39-1/4 x 19-11/16) x 3
Net Weight	kg	(140 x 1) + (127 x 1)	140 x 2	(140 x 1) + (127 x 2)	(140 x 1) + (127 x 2)
	lbs	(309 x 1) + (280 x 1)	309 x 2	(309 x 1) + (280 x 2)	(309 x 1) + (280 x 2)
Transmission Cable (CVV-SB)	Name	R410A	R410A	R410A	R410A
	Charge Amount kg	3.0 + 5.8	3.0 + 3.0	3.0 + 5.8 + 5.8	3.0 + 5.8 + 5.8
Refrigerant	Control Device	EEV	EEV	EEV	EEV
	Power Supply	∅, V, Hz	3, 380 - 415, 50 3, 380, 60	3, 380 - 415, 50 3, 380, 60	3, 380 - 415, 50 3, 380, 60
Sound Pressure Level	Cooling dB(A)	59	55	60	60
	Heating dB(A)	61	61	62	62
Sound Power Level	Cooling dB(A)	72	68	73	74
	Heating dB(A)	74	74	76	76

※ This product contains Fluorinated Greenhouse Gases. (R410A)

Note : 1. Capacities and Inputs are based on the following conditions.

- Cooling : Indoor temp. 27°C (80.6°F) DB / 19°C (66.2°F) WB, Water inlet temp. 30°C (86°F), Interconnecting piping length 7.5m, Level difference of zero
- Heating : Indoor temp. 20°C (68°F) DB, Water inlet temp. 20°C (68°F)

2. Capacities are net capacities.

3. Due to our policy of innovation some specifications may be changed without notification.

4. Add an anti-freeze to circulation water when Outdoor unit is operating under 10°C (50°F), and change the DIP switch on main PCB. (For more information on installation section.)

HEAT PUMP

ARWN480LAS4 / ARWN500LAS4 / ARWN540LAS4 / ARWN600LAS4



HP		48	50	54	60
Model Name	Combination Unit	ARWN480LAS4	ARWN500LAS4	ARWN540LAS4	ARWN600LAS4
	Independent Unit	ARWN200LAS4 ARWN140LAS4 ARWN140LAS4	ARWN200DAS4 ARWN200DAS4 ARWN100DAS4	ARWN200LAS4 ARWN200LAS4 ARWN140LAS4	ARWN200LAS4 ARWN200LAS4 ARWN200LAS4
Capacity	Cooling kW	134.4	140.0	151.2	168.0
	Heating kW	151.2	157.5	170.1	189.0
Input	Cooling kW	26.88	27.49	30.24	33.60
	Heating kW	28.01	28.68	31.51	35.01
Casing Color		Warm Gray, Mornig Gray	Warm Gray, Mornig Gray	Warm Gray, Mornig Gray	Warm Gray, Mornig Gray
Compressor	Type	Hermetically Sealed Scroll	Hermetically Sealed Scroll	Hermetically Sealed Scroll	Hermetically Sealed Scroll
	Combination	(Inverter) x 3	(Inverter) x 3	(Inverter) x 3	(Inverter) x 3
	Piston Displacement cm ³ /rev	62.1 + 43.8 + 43.8	62.1 + 62.1 + 43.8	62.1 + 62.1 + 43.8	62.1 + 62.1 + 62.1
	Number of revolution rev/min	Inverter 3,600 at 60Hz	Inverter 3,600 at 60Hz	Inverter 3,600 at 60Hz	Inverter 3,600 at 60Hz
	Motor Output kW	5.3 + 4.2 + 4.2	5.3 + 5.3 + 4.2	5.3 + 5.3 + 4.2	5.3 + 5.3 + 5.3
	Starting Method	Direct On Line	Direct On Line	Direct On Line	Direct On Line
	Oil Type	FVC68D (PVE)	FVC68D (PVE)	FVC68D (PVE)	FVC68D (PVE)
	Oil Charge Amount cc	(1,400 + 1,200 + 1,200) + 1,600 x 3	(1,400 + 1,400 + 1,200) + 1,600 x 3	(1,400 + 1,400 + 1,200) + 1,600 x 3	(1,400 + 1,600) x 3
Heat Exchanger	Type	Stainless Steel Plate	Stainless Steel Plate	Stainless Steel Plate	Stainless Steel Plate
	Maximum Pressure Resistance kgf/cm ²	45	45	45	45
	Head Loss kPa	30.1 + 28.6 + 28.6	30.1 + 30.1 + 15.8	30.1 + 28.6 + 28.6	30.1 + 30.1 + 30.1
	Rated Water Flow LPM	192 + 135 + 135	192 + 192 + 96	192 + 192 + 135	192 + 192 + 192
Temp. range of Circulation water	Cooling	10°C - 45°C (50°F - 113°F)	10°C - 45°C (50°F - 113°F)	10°C - 45°C (50°F - 113°F)	10°C - 45°C (50°F - 113°F)
	Heating	-5°C - 45°C (23°F - 113°F)	-5°C - 45°C (23°F - 113°F)	-5°C - 45°C (23°F - 113°F)	-5°C - 45°C (23°F - 113°F)
Refrigerant Connecting Pipes	Liquid Pipes mm (inch)	19.05 (3/4)	19.05 (3/4)	19.05 (3/4)	19.05 (3/4)
	Gas Pipes mm (inch)	41.3 (1-5/8)	41.3 (1-5/8)	41.3 (1-5/8)	41.3 (1-5/8)
Water Connecting Pipes	Inlet mm	PT40 + PT40 + PT40 (Internal)	PT40 + PT40 + PT40 (Internal)	PT40 + PT40 + PT40 (Internal)	PT40 + PT40 + PT40 (Internal)
	Outlet mm	PT40 + PT40 + PT40 (Internal)	PT40 + PT40 + PT40 (Internal)	PT40 + PT40 + PT40 (Internal)	PT40 + PT40 + PT40 (Internal)
	Drain Outlet mm	PT20 (3/4, External)	PT20 (3/4, External)	PT20 (3/4, External)	PT20 (3/4, External)
Dimensions (W x H x D)	mm	(755 x 997 x 500) x 3	(755 x 997 x 500) x 3	(755 x 997 x 500) x 3	(755 x 997 x 500) x 3
	inch	(29-23/32 x 39-1/4 x 19-11/16) x 3	(29-23/32 x 39-1/4 x 19-11/16) x 3	(29-23/32 x 39-1/4 x 19-11/16) x 3	(29-23/32 x 39-1/4 x 19-11/16) x 3
Net Weight	kg	(140 x 1) + (127 x 2)	(140 x 2) + (127 x 1)	(140 x 2) + (127 x 1)	140 x 3
	lbs	(309 x 1) + (280 x 2)	(309 x 2) + (280x1)	(309 x 2) + (280x1)	309 x 3
Transmission Cable (CVV-SB)	Name	R410A	R410A	R410A	R410A
	Charge Amount kg	3.0 + 5.8 + 5.8	3.0 + 3.0 + 5.8	3.0 + 3.0 + 5.8	3.0 + 3.0 + 3.0
Refrigerant	Control Device	EEV	EEV	EEV	EEV
	Power Supply	∅, V, Hz	3, 380 - 415, 50 3, 380, 60	3, 380 - 415, 50 3, 380, 60	3, 380 - 415, 50 3, 380, 60
Sound Pressure Level	Cooling dB(A)	60	58	60	56
	Heating dB(A)	62	63	62	62
Sound Power Level	Cooling dB(A)	74	72	74	70
	Heating dB(A)	76	77	76	76

※ This product contains Fluorinated Greenhouse Gases. (R410A)

Note : 1. Capacities and Inputs are based on the following conditions.

- Cooling : Indoor temp. 27°C (80.6°F) DB / 19°C (66.2°F) WB, Water inlet temp. 30°C (86°F), Interconnecting piping length 7.5m, Level difference of zero
- Heating : Indoor temp. 20°C (68°F) DB, Water inlet temp. 20°C (68°F)

2. Capacities are net capacities.

3. Due to our policy of innovation some specifications may be changed without notification.

4. Add an anti-freeze to circulation water when Outdoor unit is operating under 10°C (50°F), and change the DIP switch on main PCB. (For more information on installation section.)

MULTI V WATER IV

HEAT PUMP

ARWN620LAS4 / ARWN640LAS4 / ARWN680LAS4



HP			62	64	68
Model Name	Combination Unit		ARWN620LAS4	ARWN640LAS4	ARWN680LAS4
	Independent Unit		ARWN200LAS4 ARWN200LAS4 ARWN140LAS4 ARWN080LAS4	ARWN200LAS4 ARWN200LAS4 ARWN140LAS4 ARWN100LAS4	ARWN200LAS4 ARWN200LAS4 ARWN140LAS4 ARWN140LAS4
Capacity	Cooling	kW	173.6	179.2	190.4
	Heating	kW	195.3	201.6	214.2
Input	Cooling	kW	34.10	35.33	38.08
	Heating	kW	35.71	36.85	39.68
Casing Color			Warm Gray, Mornig Gray	Warm Gray, Mornig Gray	Warm Gray, Mornig Gray
Compressor	Type		Hermetically Sealed Scroll	Hermetically Sealed Scroll	Hermetically Sealed Scroll
	Combination		(Inverter) x 4	(Inverter) x 4	(Inverter) x 4
	Piston Displacement	cm ³ /rev	62.1 + 62.1 + 43.8 + 43.8	62.1 + 62.1 + 43.8 + 43.8	62.1 + 62.1 + 43.8 + 43.8
	Number of revolution	rev/min	Inverter 3,600 at 60Hz	Inverter 3,600 at 60Hz	Inverter 3,600 at 60Hz
	Motor Output	kW	5.3 + 5.3 + 4.2 + 4.2	5.3 + 5.3 + 4.2 + 4.2	5.3 + 5.3 + 4.2 + 4.2
	Starting Method		Direct On Line	Direct On Line	Direct On Line
	Oil Type		FVC68D (PVE)	FVC68D (PVE)	FVC71D (PVE)
	Oil Charge Amount	cc	(1,400 x 2 + 1,200 x 2) + (1,600 x 4)	(1,400 x 2 + 1,200 x 2) + (1,600 x 4)	(1,400 x 2 + 1,200 x 2) + (1,600 x 4)
Heat Exchanger	Type		Stainless Steel Plate	Stainless Steel Plate	Stainless Steel Plate
	Maximum Pressure Resistance	kgf/cm ²	45	45	45
	Head Loss	kPa	30.1 + 30.1 + 28.6 + 10.7	30.1 + 30.1 + 28.6 + 15.8	30.1 + 30.1 + 28.6 + 28.6
	Rated Water Flow	LPM	192 + 192 + 135 + 77	192 + 192 + 135 + 96	192 + 192 + 135 + 135
Temp. range of	Cooling		10°C - 45°C (50°F - 113°F)	10°C - 45°C (50°F - 113°F)	10°C - 45°C (50°F - 116°F)
Circulation water	Heating		-5°C - 45°C (23°F - 113°F)	-5°C - 45°C (23°F - 113°F)	-5°C - 45°C (23°F - 116°F)
Refrigerant Connecting Pipes	Liquid Pipes	mm (inch)	19.05 (3/4)	19.05 (3/4)	22.2 (7/8)
	Gas Pipes	mm (inch)	41.3 (1-5/8)	41.3 (1-5/8)	53.98 (2-1/8)
Water Connecting Pipes	Inlet	mm	PT40 + PT40 + PT40 (Internal)	PT40 + PT40 + PT40 (Internal)	PT 40 + PT 40 + PT 40 + PT40
	Outlet	mm	PT40 + PT40 + PT40 (Internal)	PT40 + PT40 + PT40 (Internal)	PT 40 + PT 40 + PT 40 + PT40
	Drain Outlet	mm	PT20 (3/4, External)	PT20 (3/4, External)	PT20 (3/4, External)
Dimensions (W x H x D)	mm		(755 x 997 x 500) x 4	(755 x 997 x 500) x 4	(755 x 997 x 500) x 4
	inch		(29-23/32 x 39-1/4 x 19-11/16) x 4	(29-23/32 x 39-1/4 x 19-11/16) x 4	(29-23/32 x 39-1/4 x 19-11/16) x 4
Net Weight	kg		(140 x 2) + (127 x 2)	(140 x 2) + (127 x 2)	(140 x 2) + (127 x 2)
	lbs		(309 x 2) + (280 x 2)	(309 x 2) + (280 x 2)	(309 x 2) + (280 x 2)
Transmission Cable (CVV-SB)		mm ²	1.0 - 1.5 x 2C	1.0 - 1.5 x 2C	1.0 - 1.5 x 5C
Refrigerant	Name		R410A	R410A	R410A
	Charge Amount	kg	5.8 + 5.8 + 3.0 + 3.0	5.8 + 5.8 + 3.0 + 3.0	5.8 + 5.8 + 3.0 + 3.0
	Control Device		EEV	EEV	EEV
Power Supply		∅, V, Hz	3, 380 - 415, 50	3, 380 - 415, 50	6, 380 - 415, 50
			3, 380, 60	3, 380, 60	6, 380, 60
Sound Pressure Level	Cooling	dB(A)	61	61	61
	Heating	dB(A)	64	64	63
Sound Power Level	Cooling	dB(A)	75	75	75
	Heating	dB(A)	79	79	77

※ This product contains Fluorinated Greenhouse Gases. (R410A)

Note : 1. Capacities and Inputs are based on the following conditions.

- Cooling : Indoor temp. 27°C (80.6°F) DB / 19°C (66.2°F) WB, Water inlet temp. 30°C (86°F), Interconnecting piping length 7.5m, Level difference of zero

- Heating : Indoor temp. 20°C (68°F) DB, Water inlet temp. 20°C (68°F)

2. Capacities are net capacities.

3. Due to our policy of innovation some specifications may be changed without notification.

4. Add an anti-freeze to circulation water when Outdoor unit is operating under 10°C (50°F), and change the DIP switch on main PCB. (For more information on installation section.)

HEAT PUMP

ARWN700LAS4 / ARWN740LAS4 / ARWN800LAS4



HP			70	74	80
Model Name	Combination Unit		ARWN700LAS4	ARWN740LAS4	ARWN800LAS4
	Independent Unit		ARWN200LAS4 ARWN200LAS4 ARWN200LAS4 ARWN100LAS4	ARWN200LAS4 ARWN200LAS4 ARWN200LAS4 ARWN140LAS4	ARWN200LAS4 ARWN200LAS4 ARWN200LAS4 ARWN200LAS4
Capacity	Cooling	kW	196.0	184.8	201.6
	Heating	kW	220.5	207.9	226.8
Input	Cooling	kW	38.69	35.53	38.76
	Heating	kW	40.35	37.14	40.52
Casing Color			Warm Gray, Mornig Gray	Warm Gray, Mornig Gray	Warm Gray, Mornig Gray
Compressor	Type		Hermetically Sealed Scroll	Hermetically Sealed Scroll	Hermetically Sealed Scroll
	Combination		(Inverter) x 4	(Inverter) x 4	(Inverter) x 4
	Piston Displacement	cm ³ /rev	62.1 + 62.1 + 62.1 + 43.8	62.1 + 62.1 + 62.1 + 43.8	62.1 + 62.1 + 62.1 + 62.1
	Number of revolution	rev/min	Inverter 3,600 at 60Hz	Inverter 3,600 at 60Hz	Inverter 3,600 at 60Hz
	Motor Output	kW	5.3 + 5.3 + 5.3 + 4.2	5.3 + 5.3 + 5.3 + 4.2	5.3 + 5.3 + 5.3 + 5.3
	Starting Method		Direct On Line	Direct On Line	Direct On Line
	Oil Type		FVC71D (PVE)	FVC74D (PVE)	FVC77D (PVE)
	Oil Charge Amount	cc	(1,400 x 3 + 1,200) + (1,600 x 4)	(1,400 x 3 + 1,200) + (1,600 x 4)	(1,400 + 1,600) x 4
Heat Exchanger	Type		Stainless Steel Plate	Stainless Steel Plate	Stainless Steel Plate
	Maximum Pressure Resistance	kgf/cm ²	45	45	45
	Head Loss	kPa	30.1 + 30.1 + 30.1 + 15.8	30.1 + 30.1 + 30.1 + 28.6	30.1 + 30.1 + 30.1 + 30.1
	Rated Water Flow	LPM	192 + 192 + 192 + 96	192 + 192 + 192 + 135	192 + 192 + 192 + 192
Temp. range of	Cooling		10°C - 45°C (50°F - 116°F)	10°C - 45°C (50°F - 119°F)	10°C - 45°C (50°F - 122°F)
Circulation water	Heating		-5°C - 45°C (23°F - 116°F)	-5°C - 45°C (23°F - 119°F)	-5°C - 45°C (23°F - 122°F)
Refrigerant Connecting Pipes	Liquid Pipes	mm (inch)	22.2 (7/8)	22.2 (7/8)	22.2 (7/8)
	Gas Pipes	mm (inch)	53.98 (2-1/8)	53.98 (2-1/8)	53.98 (2-1/8)
Water Connecting Pipes	Inlet	mm	PT 40 + PT 40 + PT 40 + PT40	PT 40 + PT 40 + PT 40 + PT 40	PT 40 + PT 40 + PT 40 + PT 40
	Outlet	mm	PT 40 + PT 40 + PT 40 + PT40	PT 40 + PT 40 + PT 40 + PT 40	PT 40 + PT 40 + PT 40 + PT 40
	Drain Outlet	mm	PT20 (3/4, External)	PT20 (3/4, External)	PT20 (3/4, External)
Dimensions (W x H x D)	mm		(755 x 997 x 500) x 4	(755 x 997 x 500) x 4	(755 x 997 x 500) x 4
	inch		(29-23/32 x 39-1/4 x 19-11/16) x 4	(29-23/32 x 39-1/4 x 19-11/16) x 4	(29-23/32 x 39-1/4 x 19-11/16) x 4
Net Weight	kg		(140 x 2) + (127 x 2)	(140 x 3) + (127 x 1)	140 x 4
	lbs		(309 x 2) + (280 x 2)	(309 x 3) + (280 x 1)	309 x 4
Transmission Cable (CVV-SB)		mm ²	1.0 - 1.5 x 5C	1.0 - 1.5 x 8C	1.0 - 1.5 x 11C
Refrigerant	Name		R410A	R410A	R410A
	Charge Amount	kg	5.8 + 5.8 + 3.0 + 3.0	3.0 + 3.0 + 3.0 + 5.8	3.0 + 3.0 + 3.0 + 3.0
	Control Device		EEV	EEV	EEV
Power Supply		∅, V, Hz	6, 380 - 415, 50	9, 380 - 415, 50	12, 380 - 415, 50
			6, 380, 60	9, 380, 60	12, 380, 60
Sound Pressure Level	Cooling	dB(A)	60	61	57
	Heating	dB(A)	65	63	63
Sound Power Level	Cooling	dB(A)	74	75	71
	Heating	dB(A)	80	77	77

※ This product contains Fluorinated Greenhouse Gases. (R410A)

Note : 1. Capacities and Inputs are based on the following conditions.

- Cooling : Indoor temp. 27°C (80.6°F) DB / 19°C (66.2°F) WB, Water inlet temp. 30°C (86°F), Interconnecting piping length 7.5m, Level difference of zero

- Heating : Indoor temp. 20°C (68°F) DB, Water inlet temp. 20°C (68°F)

2. Capacities are net capacities.

3. Due to our policy of innovation some specifications may be changed without notification.

4. Add an anti-freeze to circulation water when Outdoor unit is operating under 10°C (50°F), and change the DIP switch on main PCB. (For more information on installation section.)

MULTI V WATER IV

HEAT RECOVERY

ARWB080LAS4 / ARWB100LAS4 / ARWB140LAS4 / ARWB200LAS4



HP			8	10	14	20
Model Name	Combination Unit		ARWB080LAS4	ARWB100LAS4	ARWB140LAS4	ARWB200LAS4
	Independent Unit		ARWB080LAS4	ARWB100LAS4	ARWB140LAS4	ARWB200LAS4
Capacity	Cooling	kW	22.4	28.0	39.2	56.0
	Heating	kW	25.2	31.5	44.1	63.0
Input	Cooling	kW	3.86	5.09	7.84	11.20
	Heating	kW	4.20	5.34	8.17	11.67
Casing Color			Warm Gray, Mornig Gray	Warm Gray, Mornig Gray	Warm Gray, Mornig Gray	Warm Gray, Mornig Gray
Compressor	Type		Hermetically Sealed Scroll	Hermetically Sealed Scroll	Hermetically Sealed Scroll	Hermetically Sealed Scroll
	Combination		(Inverter) x 1	(Inverter) x 1	(Inverter) x 1	(Inverter) x 1
	Piston Displacement	cm ³ /rev	43.8	43.8	43.8	62.1
	Number of revolution	rev/min	Inverter 3,600 at 60Hz	Inverter 3,600 at 60Hz	Inverter 3,600 at 60Hz	Inverter 3,600 at 60Hz
	Motor Output	kW	4.2	4.2	4.2	5.3
	Starting Method		Direct On Line	Direct On Line	Direct On Line	Direct On Line
	Oil Type		FVC68D (PVE)	FVC68D (PVE)	FVC68D (PVE)	FVC68D (PVE)
	Oil Charge Amount	cc	1,200 + 1,600	1,200 + 1,600	1,200 + 1,600	1,400 + 1,600
Heat Exchanger	Type		Stainless Steel Plate	Stainless Steel Plate	Stainless Steel Plate	Stainless Steel Plate
	Maximum Pressure Resistance	kgf/cm ²	45	45	45	45
	Head Loss	kPa	10.7	15.8	28.6	30.1
	Rated Water Flow	LPM	77	96	135	192
Temp. range of	Cooling		10°C - 45°C (50°F - 113°F)	10°C - 45°C (50°F - 113°F)	10°C - 45°C (50°F - 113°F)	10°C - 45°C (50°F - 113°F)
Circulation water	Heating		-5°C - 45°C (23°F - 113°F)	-5°C - 45°C (23°F - 113°F)	5°C - 45°C (23°F - 113°F)	-5°C - 45°C (23°F - 113°F)
Refrigerant Connecting Pipes	Liquid Pipes	mm (inch)	9.52 (3/8)	9.52 (3/8)	12.7 (1/2)	12.7 (1/2)
	Low Pressure Gas Pipes	mm (inch)	22.2 (7/8)	22.2 (7/8)	25.4 (1)	28.58 (1-1/8)
	High Pressure Gas Pipes	mm (inch)	19.05 (3/4)	19.05 (3/4)	19.05 (3/4)	19.05 (3/4)
Water Connecting Pipes	Inlet	mm	PT40 (1-1/2, Internal)	PT40 (1-1/2, Internal)	PT40 (1-1/2, Internal)	PT40 (1-1/2, Internal)
	Outlet	mm	PT40 (1-1/2, Internal)	PT40 (1-1/2, Internal)	PT40 (1-1/2, Internal)	PT40 (1-1/2, Internal)
	Drain Outlet	mm	PT20 (3/4, External)	PT20 (3/4, External)	PT20 (3/4, External)	PT20 (3/4, External)
Dimensions (W x H x D)	mm		(755 x 500 x 997) x 1	(755 x 500 x 997) x 1	(755 x 500 x 997) x 1	(755 x 500 x 997) x 1
	inch		(29-23/32 x 39-1/4 x 19-11/16) x 1	(29-23/32 x 39-1/4 x 19-11/16) x 1	(29-23/32 x 39-1/4 x 19-11/16) x 1	(29-23/32 x 39-1/4 x 19-11/16) x 1
Net Weight	kg		127 x 1	127 x 1	127 x 1	140 x 1
	lbs		280 x 1	280 x 1	280 x 1	309 x 1
Transmission Cable (CVV-SB)	mm ²		1.0 - 1.5 x 2C	1.0 - 1.5 x 2C	1.0 - 1.5 x 2C	1.0 - 1.5 x 2C
Refrigerant	Name		R410A	R410A	R412A	R410A
	Charge Amount	kg	5.8	5.8	5.8	3.0
	Control Device		EEV	EEV	EEV	EEV
Power Supply	∅, V, Hz		3, 380 - 415, 50	3, 380 - 415, 50	3, 380 - 415, 50	3, 380 - 415, 50
			3, 380, 60	3, 380, 60	3, 380, 60	3, 380, 60
Sound Pressure Level	Cooling	dB(A)	47	50	58	54
	Heating	dB(A)	51	53	57	60
Sound Power Level	Cooling	dB(A)	59	62	70	66
	Heating	dB(A)	63	65	69	72

※ This product contains Fluorinated Greenhouse Gases. (R410A)

Note : 1. Capacities and Inputs are based on the following conditions.

- Cooling : Indoor temp. 27°C (80.6°F) DB / 19°C (66.2°F) WB, Water inlet temp. 30°C (86°F), Interconnecting piping length 7.5m, Level difference of zero

- Heating : Indoor temp. 20°C (68°F) DB, Water inlet temp. 20°C (68°F)

2. Capacities are net capacities.

3. Due to our policy of innovation some specifications may be changed without notification.

4. Add an anti-freeze to circulation water when Outdoor unit is operating under 10°C (50°F), and change the DIP switch on main PCB. (For more information on installation section.)

HEAT RECOVERY

ARWB220LAS4 / ARWB240LAS4 / ARWB280LAS4 / ARWB300LAS4



HP			22	24	28	30
Model Name	Combination Unit		ARWB220LAS4	ARWB240LAS4	ARWB280LAS4	ARWB300LAS4
	Independent Unit		ARWB140LAS4 ARWB080LAS4	ARWB140LAS4 ARWB100LAS4	ARWB140LAS4 ARWB100LAS4	ARWB200LAS4 ARWB100LAS4
Capacity	Cooling	kW	61.6	67.2	78.4	84.0
	Heating	kW	69.3	75.6	88.2	94.5
Input	Cooling	kW	11.70	12.93	15.68	16.29
	Heating	kW	12.37	13.51	16.34	17.01
Casing Color			Warm Gray, Mornig Gray	Warm Gray, Mornig Gray	Warm Gray, Mornig Gray	Warm Gray, Mornig Gray
Compressor	Type		Hermetically Sealed Scroll	Hermetically Sealed Scroll	Hermetically Sealed Scroll	Hermetically Sealed Scroll
	Combination		(Inverter) x 2	(Inverter) x 2	(Inverter) x 2	(Inverter) x 2
	Piston Displacement	cm ³ /rev	43.8 + 43.8	43.8 + 43.8	43.8 + 43.8	62.1 + 43.8
	Number of revolution	rev/min	Inverter 3,600 at 60Hz	Inverter 3,600 at 60Hz	Inverter 3,600 at 60Hz	Inverter 3,600 at 60Hz
	Motor Output	kW	4.2 + 4.2	4.2 + 4.2	4.2 + 4.2	5.3 + 4.2
	Starting Method		Direct On Line	Direct On Line	Direct On Line	Direct On Line
	Oil Type		FVC68D (PVE)	FVC68D (PVE)	FVC68D (PVE)	FVC68D (PVE)
	Oil Charge Amount	cc	(1,200 + 1,600) x 2	(1,200 + 1,600) x 2	(1,200 + 1,600) x 2	(1,400 + 1,200) + 1,600 x 2
Heat Exchanger	Type		Stainless Steel Plate	Stainless Steel Plate	Stainless Steel Plate	Stainless Steel Plate
	Maximum Pressure Resistance	kgf/cm ²	45	45	45	45
	Head Loss	kPa	28.6 + 10.7	28.6 + 15.8	28.6 + 28.6	30.1 + 15.8
	Rated Water Flow	LPM	135 + 77	135 + 96	135 + 135	192 + 96
Temp. range of	Cooling		10°C - 45°C (50°F - 113°F)	10°C - 45°C (50°F - 113°F)	10°C - 45°C (50°F - 113°F)	10°C - 45°C (50°F - 113°F)
Circulation water	Heating		-5°C - 45°C (23°F - 113°F)	-5°C - 45°C (23°F - 113°F)	-5°C - 45°C (23°F - 113°F)	-5°C - 45°C (23°F - 113°F)
Refrigerant Connecting Pipes	Liquid Pipes	mm (inch)	19.05 (3/4)	19.05 (3/4)	19.05 (3/4)	19.05 (3/4)
	Low Pressure Gas Pipes	mm (inch)	34.9 (1-3/8)	34.9 (1-3/8)	34.9 (1-3/8)	34.9 (1-3/8)
	High Pressure Gas Pipes	mm (inch)	28.58 (1-1/8)	28.58 (1-1/8)	28.58 (1-1/8)	28.58 (1-1/8)
Water Connecting Pipes	Inlet	mm	PT40 + PT40 (Internal)	PT40 + PT40 (Internal)	PT40 + PT40 (Internal)	PT40 + PT40 (Internal)
	Outlet	mm	PT40 + PT40 (Internal)	PT40 + PT40 (Internal)	PT40 + PT40 (Internal)	PT40 + PT40 (Internal)
	Drain Outlet	mm	PT20 (3/4, External)	PT20 (3/4, External)	PT20 (3/4, External)	PT20 (3/4, External)
Dimensions (W x H x D)	mm		(755 x 997 x 500) x 2	(755 x 997 x 500) x 2	(755 x 997 x 500) x 2	(755 x 997 x 500) x 2
	inch		(29-23/32 x 39-1/4 x 19-11/16) x 2	(29-23/32 x 39-1/4 x 19-11/16) x 2	(29-23/32 x 39-1/4 x 19-11/16) x 2	(29-23/32 x 39-1/4 x 19-11/16) x 2
Net Weight	kg		127 x 2	127 x 2	127 x 2	(140 x 1) + (127 x 1)
	lbs		280 x 2	280 x 2	280 x 2	(309 x 1) + (280 x 1)
Transmission Cable (CVV-SB)	mm ²		1.0 - 1.5 x 2C	1.0 - 1.5 x 2C	1.0 - 1.5 x 2C	1.0 - 1.5 x 2C
Refrigerant	Name		R410A	R410A	R410A	R410A
	Charge Amount	kg	5.8 + 5.8	5.8 + 5.8	5.8 + 5.8	3.0 + 5.8
	Control Device		EEV	EEV	EEV	EEV
Power Supply	∅, V, Hz		3, 380 - 415, 50	3, 380 - 415, 50	3, 380 - 415, 50	3, 380 - 415, 50
			3, 380, 60	3, 380, 60	3, 380, 60	3, 380, 60
Sound Pressure Level	Cooling	dB(A)	58	59	59	55
	Heating	dB(A)	58	58	58	61
Sound Power Level	Cooling	dB(A)	71	72	72	68
	Heating	dB(A)	71	71	71	74

※ This product contains Fluorinated Greenhouse Gases. (R410A)

Note : 1. Capacities and Inputs are based on the following conditions.

- Cooling : Indoor temp. 27°C (80.6°F) DB / 19°C (66.2°F) WB, Water inlet temp. 30°C (86°F), Interconnecting piping length 7.5m, Level difference of zero

- Heating : Indoor temp. 20°C (68°F) DB, Water inlet temp. 20°C (68°F)

2. Capacities are net capacities.

3. Due to our policy of innovation some specifications may be changed without notification.

4. Add an anti-freeze to circulation water when Outdoor unit is operating under 10°C (50°F), and change the DIP switch on main PCB. (For more information on installation section.)

MULTI V WATER IV

HEAT RECOVERY

ARWB340LAS4 / ARWB400LAS4 / ARWB420LAS4 / ARWB440LAS4



HP		34	40	42	44
Model Name	Combination Unit	ARWB340LAS4	ARWB400LAS4	ARWB420LAS4	ARWB440LAS4
	Independent Unit	ARWB200LAS4 ARWB140LAS4	ARWB200LAS4 ARWB200LAS4	ARWB200LAS4 ARWB140LAS4 ARWB080LAS4	ARWB200LAS4 ARWB140LAS4 ARWB100LAS4
Capacity	Cooling kW	95.2	112.0	117.6	123.2
	Heating kW	107.1	126.0	132.3	138.6
Input	Cooling kW	19.04	22.40	22.90	24.13
	Heating kW	19.84	23.34	24.04	25.18
Casing Color		Warm Gray, Mornig Gray	Warm Gray, Mornig Gray	Warm Gray, Mornig Gray	Warm Gray, Mornig Gray
Compressor	Type	Hermetically Sealed Scroll	Hermetically Sealed Scroll	Hermetically Sealed Scroll	Hermetically Sealed Scroll
	Combination	(Inverter) x 2	(Inverter) x 2	(Inverter) x 3	(Inverter) x 3
	Piston Displacement cm ³ /rev	43.8 + 62.1	62.1 + 62.1	62.1 + 43.8 + 43.8	62.1 + 43.8 + 43.8
	Number of revolution rev/min	Inverter 3,600 at 60Hz	Inverter 3,600 at 60Hz	Inverter 3,600 at 60Hz	Inverter 3,600 at 60Hz
	Motor Output kW	4.2 + 5.3	5.3 + 5.3	5.3 + 4.2 + 4.2	5.3 + 4.2 + 4.2
	Starting Method	Direct On Line	Direct On Line	Direct On Line	Direct On Line
	Oil Type	FVC68D (PVE)	FVC68D (PVE)	FVC68D (PVE)	FVC68D (PVE)
	Oil Charge Amount cc	(1,400 + 1,200) + 1,600 x 2	(1,400 + 1,600) x 2	(1,400 + 1,200 + 1,200) + 1,600 x 3	(1,400 + 1,200 + 1,200) + 1,600 x 3
	Type	Stainless Steel Plate	Stainless Steel Plate	Stainless Steel Plate	Stainless Steel Plate
Heat Exchanger	Maximum Pressure Resistance kgf/cm ²	45	45	45	45
	Head Loss kPa	30.1 + 28.6	30.1 + 30.1	30.1 + 28.6 + 10.7	30.1 + 28.6 + 15.8
	Rated Water Flow LPM	192 + 135	192 + 192	192 + 135 + 77	192 + 135 + 96
	Temp. range of Cooling	10°C - 45°C (50°F - 113°F)	10°C - 45°C (50°F - 113°F)	10°C - 45°C (50°F - 113°F)	10°C - 45°C (50°F - 113°F)
Circulation water	Heating	-5°C - 45°C (23°F - 113°F)	-5°C - 45°C (23°F - 113°F)	-5°C - 45°C (23°F - 113°F)	-5°C - 45°C (23°F - 113°F)
	Refrigerant Connecting Pipes				
Refrigerant Connecting Pipes	Liquid Pipes mm (inch)	19.05 (3/4)	19.05 (3/4)	19.05 (3/4)	19.05 (3/4)
	Low Pressure Gas Pipes mm (inch)	34.9 (1-3/8)	41.3 (1-5/8)	41.3 (1-5/8)	41.3 (1-5/8)
	High Pressure Gas Pipes mm (inch)	28.58 (1-1/8)	34.9 (1-3/8)	34.9 (1-3/8)	34.9 (1-3/8)
Water Connecting Pipes	Inlet mm	PT40 + PT40 (Internal)	PT40 + PT40 (Internal)	PT40 + PT40 + PT40 (Internal)	PT40 + PT40 + PT40 (Internal)
	Outlet mm	PT40 + PT40 (Internal)	PT40 + PT40 (Internal)	PT40 + PT40 + PT40 (Internal)	PT40 + PT40 + PT40 (Internal)
	Drain Outlet mm	PT20 (3/4, External)	PT20 (3/4, External)	PT20 (3/4, External)	PT20 (3/4, External)
Dimensions (W x H x D)	mm	(755 x 997 x 500) x 2	(755 x 997 x 500) x 2	(755 x 997 x 500) x 3	(755 x 997 x 500) x 3
	inch	(29-23/32 x 39-1/4 x 19-11/16) x 2	(29-23/32 x 39-1/4 x 19-11/16) x 2	(29-23/32 x 39-1/4 x 19-11/16) x 3	(29-23/32 x 39-1/4 x 19-11/16) x 3
Net Weight	kg	(140 x 1) + (127 x 1)	140 x 2	(140 x 1) + (127 X 2)	(140 x 1) + (127 X 2)
	lbs	(309 x 1) + (280 x 1)	309 x 2	(309 x 1) + (280 X 2)	(309 x 1) + (280 X 2)
Transmission Cable (CVV-SB)	mm ²	1.0 - 1.5 x 2C	1.0 - 1.5 x 2C	1.0 - 1.5 x 2C	1.0 - 1.5 x 2C
Refrigerant	Name	R410A	R410A	R410A	R410A
	Charge Amount kg	3.0 + 5.8	3.0 + 3.0	3.0 + 5.8 + 5.8	3.0 + 5.8 + 5.8
	Control Device	EEV	EEV	EEV	EEV
Power Supply	Ø, V, Hz	3, 380 - 415, 50	3, 380 - 415, 50	3, 380 - 415, 50	3, 380 - 415, 50
		3, 380, 60	3, 380, 60	3, 380, 60	3, 380, 60
Sound Pressure Level	Cooling dB(A)	59	55	60	60
	Heating dB(A)	61	61	62	62
Sound Power Level	Cooling dB(A)	72	68	73	74
	Heating dB(A)	74	74	76	76

※ This product contains Fluorinated Greenhouse Gases. (R410A)

Note : 1. Capacities and Inputs are based on the following conditions.

- Cooling : Indoor temp. 27°C (80.6°F) DB / 19°C (66.2°F) WB, Water inlet temp. 30°C (86°F), Interconnecting piping length 7.5m, Level difference of zero

- Heating : Indoor temp. 20°C (68°F) DB, Water inlet temp. 20°C (68°F)

2. Capacities are net capacities.

3. Due to our policy of innovation some specifications may be changed without notification.

4. Add an anti-freeze to circulation water when Outdoor unit is operating under 10°C (50°F), and change the DIP switch on main PCB. (For more information on installation section.)

HEAT RECOVERY

ARWB480LAS4 / ARWB500LAS4 / ARWB540LAS4 / ARWB600LAS4



HP		48	50	54	60
Model Name	Combination Unit	ARWB480LAS4	ARWB500LAS4	ARWB540LAS4	ARWB600LAS4
	Independent Unit	ARWB200LAS4 ARWB140LAS4 ARWB140LAS4	ARWB200DAS4 ARWB200DAS4 ARWB100DAS4	ARWB200LAS4 ARWB200LAS4 ARWB140LAS4	ARWB200LAS4 ARWB200LAS4 ARWB200LAS4
Capacity	Cooling kW	134.4	140.0	151.2	168.0
	Heating kW	151.2	157.5	170.1	189.0
Input	Cooling kW	26.88	27.49	30.24	33.60
	Heating kW	28.01	28.68	31.51	35.01
Casing Color		Warm Gray, Mornig Gray	Warm Gray, Mornig Gray	Warm Gray, Mornig Gray	Warm Gray, Mornig Gray
Compressor	Type	Hermetically Sealed Scroll	Hermetically Sealed Scroll	Hermetically Sealed Scroll	Hermetically Sealed Scroll
	Combination	(Inverter) x 3	(Inverter) x 3	(Inverter) x 3	(Inverter) x 3
	Piston Displacement cm ³ /rev	62.1 + 43.8 + 43.8	62.1 + 62.1 + 43.8	62.1 + 62.1 + 43.8	62.1 + 62.1 + 62.1
	Number of revolution rev/min	Inverter 3,600 at 60Hz	Inverter 3,600 at 60Hz	Inverter 3,600 at 60Hz	Inverter 3,600 at 60Hz
	Motor Output kW	5.3 + 4.2 + 4.2	5.3 + 5.3 + 4.2	5.3 + 5.3 + 4.2	5.3 + 5.3 + 5.3
	Starting Method	Direct On Line	Direct On Line	Direct On Line	Direct On Line
	Oil Type	FVC68D (PVE)	FVC68D (PVE)	FVC68D (PVE)	FVC68D (PVE)
	Oil Charge Amount cc	(1,400 + 1,200 + 1,200) + 1,600 x 3	(1,400 + 1,400 + 1,200) + 1,600 x 3	(1,400 + 1,400 + 1,200) + 1,600 x 3	(1,400 + 1,600) x 3
	Type	Stainless Steel Plate	Stainless Steel Plate	Stainless Steel Plate	Stainless Steel Plate
Heat Exchanger	Maximum Pressure Resistance kgf/cm ²	45	45	45	45
	Head Loss kPa	30.1 + 28.6 + 28.6	30.1 + 30.1 + 15.8	30.1 + 28.6 + 28.6	30.1 + 30.1 + 30.1
	Rated Water Flow LPM	192 + 135 + 135	192 + 192 + 96	192 + 192 + 135	192 + 192 + 192
	Temp. range of Cooling	10°C - 45°C (50°F - 113°F)	10°C - 45°C (50°F - 113°F)	10°C - 45°C (50°F - 113°F)	10°C - 45°C (50°F - 113°F)
Circulation water	Heating	-5°C - 45°C (23°F - 113°F)	-5°C - 45°C (23°F - 113°F)	-5°C - 45°C (23°F - 113°F)	-5°C - 45°C (23°F - 113°F)
	Refrigerant Connecting Pipes				
Refrigerant Connecting Pipes	Liquid Pipes mm (inch)	19.05 (3/4)	19.05 (3/4)	19.05 (3/4)	19.05 (3/4)
	Low Pressure Gas Pipes mm (inch)	41.3 (1-5/8)	41.3 (1-5/8)	41.3 (1-5/8)	41.3 (1-5/8)
	High Pressure Gas Pipes mm (inch)	34.9 (1-3/8)	34.9 (1-3/8)	34.9 (1-3/8)	34.9 (1-3/8)
Water Connecting Pipes	Inlet mm	PT40 + PT40 + PT40 (Internal)	PT40 + PT40 + PT40 (Internal)	PT40 + PT40 + PT40 (Internal)	PT40 + PT40 + PT40 (Internal)
	Outlet mm	PT40 + PT40 + PT40 (Internal)	PT40 + PT40 + PT40 (Internal)	PT40 + PT40 + PT40 (Internal)	PT40 + PT40 + PT40 (Internal)
	Drain Outlet mm	PT20 (3/4, External)	PT20 (3/4, External)	PT20 (3/4, External)	PT20 (3/4, External)
Dimensions (W x H x D)	mm	(755 x 997 x 500) x 3	(755 x 997 x 500) x 3	(755 x 997 x 500) x 3	(755 x 997 x 500) x 3
	inch	(29-23/32 x 39-1/4 x 19-11/16) x 3	(29-23/32 x 39-1/4 x 19-11/16) x 3	(29-23/32 x 39-1/4 x 19-11/16) x 3	(29-23/32 x 39-1/4 x 19-11/16) x 3
Net Weight	kg	(140 x 1) + (127 X 2)	(140 x 2) + (127 X 1)	(140 x 2) + (127 X 1)	140 x 3
	lbs	(309 x 1) + (280 X 2)	(309 x 2) + (280X1)	(309 x 2) + (280X1)	309 x 3
Transmission Cable (CVV-SB)	mm ²	1.0 - 1.5 x 2C	1.0 - 1.5 x 2C	1.0 - 1.5 x 2C	1.0 - 1.5 x 2C
Refrigerant	Name	R410A	R410A	R410A	R410A
	Charge Amount kg	3.0 + 5.8 + 5.8	3.0 + 3.0 + 5.8	3.0 + 3.0 + 5.8	3.0 + 3.0 + 3.0
	Control Device	EEV	EEV	EEV	EEV
Power Supply	Ø, V, Hz	3, 380 - 415, 50	3, 380 - 415, 50	3, 380 - 415, 50	3, 380 - 415, 50
		3, 380, 60	3, 380, 60	3, 380, 60	3, 380, 60
Sound Pressure Level	Cooling dB(A)	60	58	60	56
	Heating dB(A)	62	63	62	62
Sound Power Level	Cooling dB(A)	74	72	74	70
	Heating dB(A)	76	77	76	76

※ This product contains Fluorinated Greenhouse Gases. (R410A)

Note : 1. Capacities and Inputs are based on the following conditions.

- Cooling : Indoor temp. 27°C (80.6°F) DB / 19°C (66.2°F) WB, Water inlet temp. 30°C (86°F), Interconnecting piping length 7.5m, Level difference of zero

- Heating : Indoor temp. 20°C (68°F) DB, Water inlet temp. 20°C (68°F)

2. Capacities are net capacities.

3. Due to our policy of innovation some specifications may be changed without notification.

4. Add an anti-freeze to circulation water when Outdoor unit is operating under 10°C (50°F), and change the DIP switch on main PCB. (For more information on installation section.)

MULTI V WATER IV

HEAT RECOVERY

ARWB620LAS4 / ARWB640LAS4 / ARWB680LAS4



HP			62	64	68
Model Name	Combination Unit		ARWB620LAS4	ARWB640LAS4	ARWB680LAS4
	Independent Unit		ARWB200LAS4 ARWB200LAS4 ARWB140LAS4 ARWB080LAS4	ARWB200LAS4 ARWB200LAS4 ARWB140LAS4 ARWB100LAS4	ARWB200LAS4 ARWB200LAS4 ARWB140LAS4 ARWB140LAS4
Capacity	Cooling	kW	173.6	179.2	190.4
	Heating	kW	195.3	201.6	214.2
Input	Cooling	kW	34.10	35.33	38.08
	Heating	kW	35.71	36.85	39.68
Casing Color			Warm Gray, Mornig Gray	Warm Gray, Mornig Gray	Warm Gray, Mornig Gray
Compressor	Type		Hermetically Sealed Scroll	Hermetically Sealed Scroll	Hermetically Sealed Scroll
	Combination		(Inverter) x 4	(Inverter) x 4	(Inverter) x 4
	Piston Displacement	cm ³ /rev	62.1 + 62.1 + 43.8 + 43.8	62.1 + 62.1 + 43.8 + 43.8	62.1 + 62.1 + 43.8 + 43.8
	Number of revolution	rev/min	Inverter 3,600 at 60Hz	Inverter 3,600 at 60Hz	Inverter 3,600 at 60Hz
	Motor Output	kW	5.3 + 5.3 + 4.2 + 4.2	5.3 + 5.3 + 4.2 + 4.2	5.3 + 5.3 + 4.2 + 4.2
	Starting Method		Direct On Line	Direct On Line	Direct On Line
	Oil Type		FVC68D (PVE)	FVC68D (PVE)	FVC71D (PVE)
	Oil Charge Amount	cc	(1,400 x 2 + 1,200 x 2) + (1,600 x 4)	(1,400 x 2 + 1,200 x 2) + (1,600 x 4)	(1,400 x 2 + 1,200 x 2) + (1,600 x 4)
Heat Exchanger	Type		Stainless Steel Plate	Stainless Steel Plate	Stainless Steel Plate
	Maximum Pressure Resistance	kgf/cm ²	45	45	45
	Head Loss	kPa	30.1 + 30.1 + 28.6 + 10.7	30.1 + 30.1 + 28.6 + 15.8	30.1 + 30.1 + 28.6 + 28.6
	Rated Water Flow	LPM	192 + 192 + 135 + 77	192 + 192 + 135 + 96	192 + 192 + 135 + 135
Temp. range of	Cooling	10°C - 45°C (50°F - 113°F)	10°C - 45°C (50°F - 113°F)	10°C - 45°C (50°F - 116°F)	
Circulation water	Heating	-5°C - 45°C (23°F - 113°F)	-5°C - 45°C (23°F - 113°F)	-5°C - 45°C (23°F - 116°F)	
Refrigerant Connecting Pipes	Liquid Pipes	mm (inch)	19.05 (3/4)	19.05 (3/4)	22.2 (7/8)
	Low Pressure Gas Pipes	mm (inch)	41.3 (1-5/8)	41.3 (1-5/8)	53.98 (2-1/8)
	High Pressure Gas Pipes	mm (inch)	34.9 (1-3/8)	34.9 (1-3/8)	44.5 (1-3/4)
Water Connecting Pipes	Inlet	mm	PT40 + PT40 + PT40 (Internal)	PT40 + PT40 + PT40 (Internal)	PT 40 + PT 40 + PT 40 + PT40
	Outlet	mm	PT40 + PT40 + PT40 (Internal)	PT40 + PT40 + PT40 (Internal)	PT 40 + PT 40 + PT 40 + PT40
	Drain Outlet	mm	PT20 (3/4, External)	PT20 (3/4, External)	PT20 (3/4, External)
Dimensions (W x H x D)	mm		(755 x 997 x 500) x 4	(755 x 997 x 500) x 4	(755 x 997 x 500) x 4
	inch		(29-23/32 x 39-1/4 x 19-11/16) x 4	(29-23/32 x 39-1/4 x 19-11/16) x 4	(29-23/32 x 39-1/4 x 19-11/16) x 4
Net Weight	kg		(140 x 2) + (127 X 2)	(140 x 2) + (127 X 2)	(140 x 2) + (127 X 2)
	lbs		(309 x 2) + (280X2)	(309 x 2) + (280X2)	(309 x 2) + (280 X 2)
Transmission Cable (CVV-SB)	mm ²		1.0 - 1.5 x 2C	1.0 - 1.5 x 2C	1.0 - 1.5 x 5C
Refrigerant	Name		R410A	R410A	R410A
	Charge Amount	kg	5.8 + 5.8 + 3.0 + 3.0	5.8 + 5.8 + 3.0 + 3.0	5.8 + 5.8 + 3.0 + 3.0
	Control Device		EEV	EEV	EEV
Power Supply	∅, V, Hz		3, 380 - 415, 50	3, 380 - 415, 50	6, 380 - 415, 50
			3, 380, 60	3, 380, 60	6, 380, 60
Sound Pressure Level	Cooling	dB(A)	61	61	61
	Heating	dB(A)	64	64	63
Sound Power Level	Cooling	dB(A)	75	75	75
	Heating	dB(A)	79	79	77

※ This product contains Fluorinated Greenhouse Gases. (R410A)
 Note : 1. Capacities and Inputs are based on the following conditions.
 - Cooling : Indoor temp. 27°C (80.6°F) DB / 19°C (66.2°F) WB, Water inlet temp. 30°C (86°F), Interconnecting piping length 7.5m, Level difference of zero
 - Heating : Indoor temp. 20°C (68°F) DB, Water inlet temp. 20°C (68°F)
 2. Capacities are net capacities.
 3. Due to our policy of innovation some specifications may be changed without notification.
 4. Add an anti-freeze to circulation water when Outdoor unit is operating under 10°C (50°F), and change the DIP switch on main PCB. (For more information on installation section.)

HEAT RECOVERY

ARWB700LAS4 / ARWB740LAS4 / ARWB800LAS4



HP			70	74	80
Model Name	Combination Unit		ARWB700LAS4	ARWB740LAS4	ARWB800LAS4
	Independent Unit		ARWB200LAS4 ARWB200LAS4 ARWB200LAS4 ARWB100LAS4	ARWB200LAS4 ARWB200LAS4 ARWB200LAS4 ARWB140LAS4	ARWB200LAS4 ARWB200LAS4 ARWB200LAS4 ARWB200LAS4
Capacity	Cooling	kW	196.0	184.8	201.6
	Heating	kW	220.5	207.9	226.8
Input	Cooling	kW	38.69	35.53	38.76
	Heating	kW	40.35	37.14	40.52
Casing Color			Warm Gray, Mornig Gray	Warm Gray, Mornig Gray	Warm Gray, Mornig Gray
Compressor	Type		Hermetically Sealed Scroll	Hermetically Sealed Scroll	Hermetically Sealed Scroll
	Combination		(Inverter) x 4	(Inverter) x 4	(Inverter) x 4
	Piston Displacement	cm ³ /rev	62.1 + 62.1 + 62.1 + 43.8	62.1 + 62.1 + 62.1 + 43.8	62.1 + 62.1 + 62.1 + 62.1
	Number of revolution	rev/min	Inverter 3,600 at 60Hz	Inverter 3,600 at 60Hz	Inverter 3,600 at 60Hz
	Motor Output	kW	5.3 + 5.3 + 5.3 + 4.2	5.3 + 5.3 + 5.3 + 4.2	5.3 + 5.3 + 5.3 + 5.3
	Starting Method		Direct On Line	Direct On Line	Direct On Line
	Oil Type		FVC71D (PVE)	FVC74D (PVE)	FVC77D (PVE)
	Oil Charge Amount	cc	(1,400 x 3 + 1,200) + (1,600 x 4)	(1,400 x 3 + 1,200) + (1,600 x 4)	(1,400 + 1,600) x 4
Heat Exchanger	Type		Stainless Steel Plate	Stainless Steel Plate	Stainless Steel Plate
	Maximum Pressure Resistance	kgf/cm ²	45	45	45
	Head Loss	kPa	30.1 + 30.1 + 30.1 + 15.8	30.1 + 30.1 + 30.1 + 28.6	30.1 + 30.1 + 30.1 + 30.1
	Rated Water Flow	LPM	192 + 192 + 192 + 96	192 + 192 + 192 + 135	192 + 192 + 192 + 192
Temp. range of	Cooling	10°C - 45°C (50°F - 116°F)	10°C - 45°C (50°F - 119°F)	10°C - 45°C (50°F - 122°F)	
Circulation water	Heating	-5°C - 45°C (23°F - 116°F)	-5°C - 45°C (23°F - 119°F)	-5°C - 45°C (23°F - 122°F)	
Refrigerant Connecting Pipes	Liquid Pipes	mm (inch)	22.2 (7/8)	22.2 (7/8)	22.2 (7/8)
	Low Pressure Gas Pipes	mm (inch)	53.98 (2-1/8)	53.98 (2-1/8)	53.98 (2-1/8)
	High Pressure Gas Pipes	mm (inch)	44.5 (1-3/4)	44.5 (1-3/4)	44.5 (1-3/4)
Water Connecting Pipes	Inlet	mm	PT 40 + PT 40 + PT 40 + PT40	PT 40 + PT 40 + PT 40 + PT 40	PT 40 + PT 40 + PT 40 + PT 40
	Outlet	mm	PT 40 + PT 40 + PT 40 + PT40	PT 40 + PT 40 + PT 40 + PT 40	PT 40 + PT 40 + PT 40 + PT 40
	Drain Outlet	mm	PT20 (3/4, External)	PT20 (3/4, External)	PT20 (3/4, External)
Dimensions (W x H x D)	mm		(755 x 997 x 500) x 4	(755 x 997 x 500) x 4	(755 x 997 x 500) x 4
	inch		(29-23/32 x 39-1/4 x 19-11/16) x 4	(29-23/32 x 39-1/4 x 19-11/16) x 4	(29-23/32 x 39-1/4 x 19-11/16) x 4
Net Weight	kg		(140 x 2) + (127 X 2)	(140 x 3) + (127 x 1)	140 x 4
	lbs		(309 x 2) + (280 X 2)	(309 x 3) + (280 x 1)	309 x 4
Transmission Cable (CVV-SB)	mm ²		1.0 - 1.5 x 5C	1.0 - 1.5 x 8C	1.0 - 1.5 x 11C
Refrigerant	Name		R410A	R410A	R410A
	Charge Amount	kg	5.8 + 5.8 + 3.0 + 3.0	3.0 + 3.0 + 3.0 + 5.8	3.0 + 3.0 + 3.0 + 3.0
	Control Device		EEV	EEV	EEV
Power Supply	∅, V, Hz		6, 380 - 415, 50	9 / 380 - 415 / 50	12 / 380 - 415 / 50
			6, 380, 60	9 / 380 / 60	12 / 380 / 60
Sound Pressure Level	Cooling	dB(A)	60	61	57
	Heating	dB(A)	65	63	63
Sound Power Level	Cooling	dB(A)	74	75	71
	Heating	dB(A)	80	77	77

※ This product contains Fluorinated Greenhouse Gases. (R410A)
 Note : 1. Capacities and Inputs are based on the following conditions.
 - Cooling : Indoor temp. 27°C (80.6°F) DB / 19°C (66.2°F) WB, Water inlet temp. 30°C (86°F), Interconnecting piping length 7.5m, Level difference of zero
 - Heating : Indoor temp. 20°C (68°F) DB, Water inlet temp. 20°C (68°F)
 2. Capacities are net capacities.
 3. Due to our policy of innovation some specifications may be changed without notification.
 4. Add an anti-freeze to circulation water when Outdoor unit is operating under 10°C (50°F), and change the DIP switch on main PCB. (For more information on installation section.)

INDOOR UNITS

- WALL MOUNTED UNIT
- SMART DUAL VANE CASSETTE
- ROUND CASSETTE
- CEILING MOUNTED CASSETTE
- CEILING CONCEALED DUCT
- FRESH AIR INTAKE UNIT

- FLOOR STANDING UNIT
- CEILING SUSPENDED UNIT
- CEILING & FLOOR CONVERTIBLE UNIT
- CONSOLE & FLOOR STANDING UNIT
- COMPATIBILITY
- FEATURE FUNCTIONS



Advanced Air Conditioning System

COOLING WITH PURIFIED AIR

Powerful air-purifying performance

CAC certification guarantees powerful air purification performance to large space.

CAC certification?

The Korea Air Cleaning Association strictly tests the air cleaning function of air conditioner products and provide certification to the product that give credibility to consumers.



Air purification Performance Testing Result

Testing institute : Korea Institute of Machinery and Materials.

Test Standard : KACA-CAC-2011, Air purification integrated air conditioner

Maker : LG Electronics

Model Name : RNW1450T2S(14.5kW, 48kBtu/h)

※ This model name is Korean market model name

No	Testing Item	Unit	Testing Result	Standard
1	Clean Air Delivery Rate (CADR)	m ³ /min	19.1	10.0 m ³ /min†
		m ³ /h	1145	
2	Harmful Gas Removal Efficiency	%	63	
3	Ozone generation density	ppm	TR	0.01↓
4	Noise Level	dB(A)	48.9	55↓
5	Treatable Area	m ²	147	

5-Step Air Cleaning Process

5-Step air cleaning process removes invisible, ultra fine dust, odor and germs to ensure a clean and healthy living environment.

1 st Step	2 nd Step	3 rd Step	4 th Step	5 th Step
Pre filter Multi layer structure allows dust removal efficiency to be 2.5 times higher and dust is also reduced by more than 40% Cleaning every 2 weeks Washing with water	Anion Emission Anion increases the electrostatic force of dust Improves dust collection efficiency on filter No need of replacement	Ultra-fine dust filter Fine to ultra-fine dust removal of up to 99% Cleaning every 6 months Washing with water	Photocatalytic deodorization filter High efficiency gas absorption technology by application of corotation concept. Deodorizing Efficiency Up! Pressure loss Down! Cleaning every 6 months Dry	Sterilization Ionizer High concentration plasma ion emission. Sterilize the virus that can cause food poisoning and pneumonia No need of replacement

Real time Air Quality Monitoring

The condition of the air is displayed in different colors on the LED display. The remote control can check the dust concentration in numerical values PM 1.0 sensor detects dust density of three sizes (Fine dust, Ultra-fine dust and Micro-fine dust) You can check the indoor air condition on the cassette panel and the remote control.

LED Lamp Colors

- Good (Blue)
- Normal (Green)
- Bad (Yellow)
- Very Bad (Red)

You can check the dust status by the remote controller.

LG ThinQ App

Air quality monitoring and operation control can be managed easily through Wi-Fi mobile application LG ThinQ.

Air Quality Monitoring
 Easy monitoring of indoor air quality
 Ultra fine / Fine dust level
 Day / Week / Month / Yearly trend

Smart Remote Control
 Control air conditioner with smart phone at any time any where
 Mode / Temp. / Air speed / Wind direction

Energy Consumption Monitoring
 Energy consumption and trend monitoring
 Setting target Energy consumption

※ Wi-Fi Module needed.

Advanced Air Conditioning Technology

ENERGY EFFICIENCY

1 Point External Input (On / Off Control)

Indoor units can control external devices without dry contact, so customer can save cost of installation.

Connection between an indoor unit and external devices directly

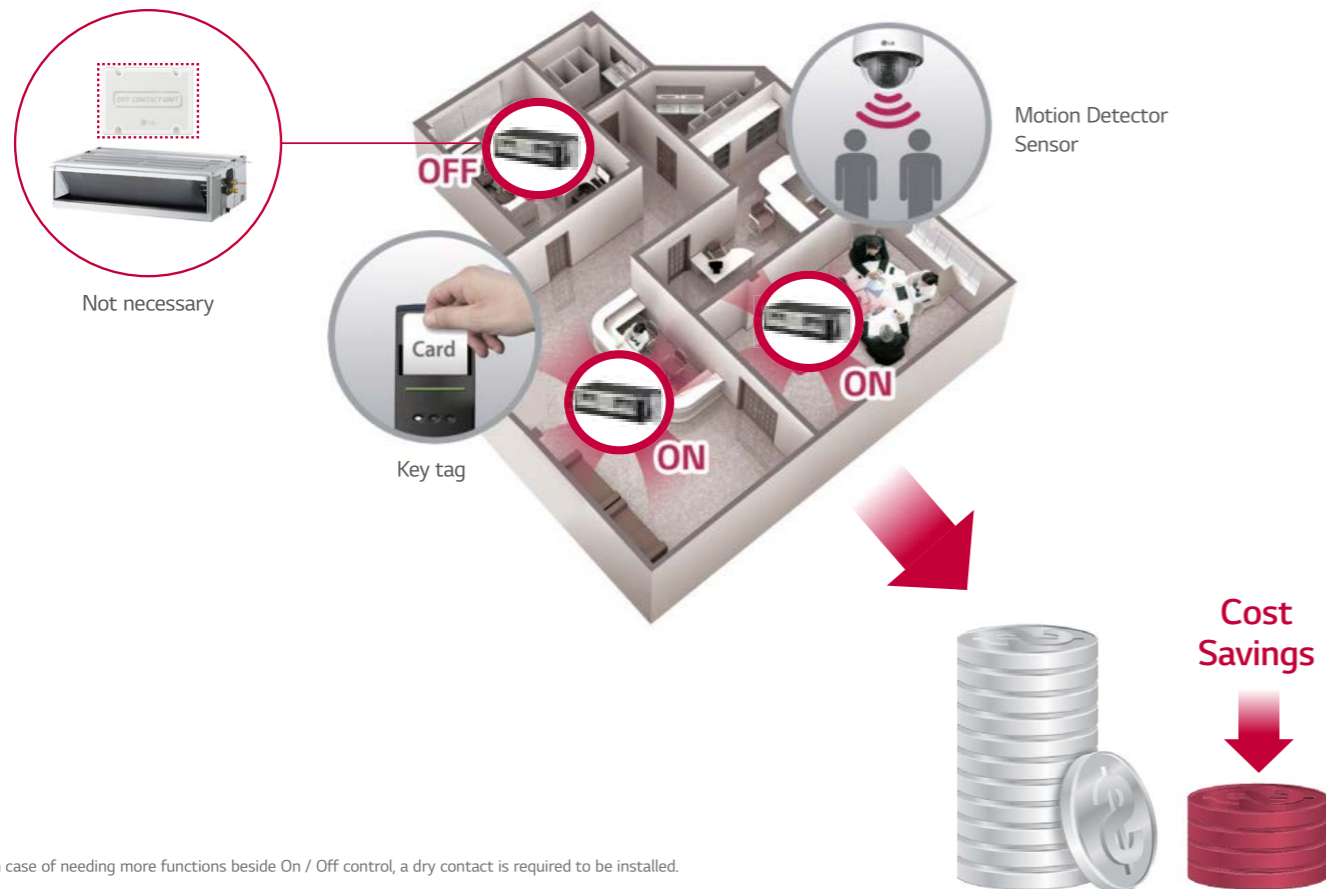

※ In case of needing more functions beside On / Off control, a dry contact is required to be installed.

Energy Monitoring (Accumulated Electric Energy Check)

Accumulated electric energy of the indoor unit can be identified with wired remote control, as well as with the central controller. This function is an advantage for energy management.

Install Scene

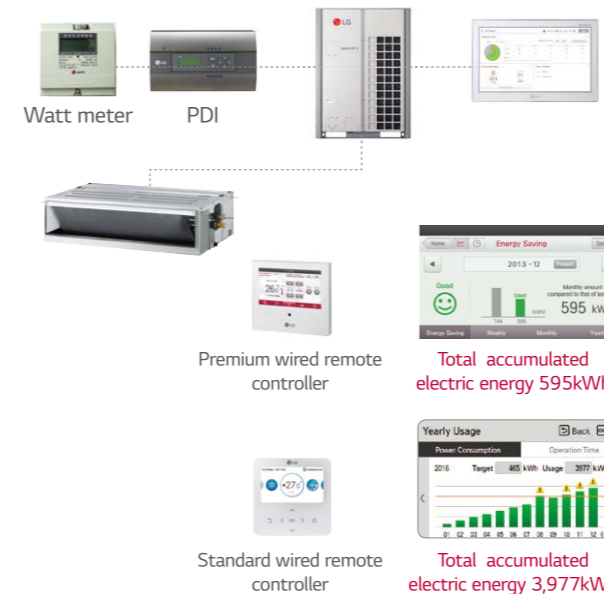

Apply for Multistory Building



※ Outdoor unit's accumulated electric energy / using rate of individual indoor unit + indoor unit's accumulated electric energy is displayed in wired remote controller, only when central controller, digital integrating electricity meter and PDI are installed and PDI, outdoor unit and indoor unit are connected with power wire. Only total accumulated electric energy is displayed in standard wired remote controller. In premium wired remote controller, that are displayed into week / month / year.

Filter Sign (Remaining Time)

The alarm is activated when the filter needs to be cleaned, and the time remaining for cleaning is displayed on the screen, which is convenient for users.

Remain time until indoor filter cleaning + alarm

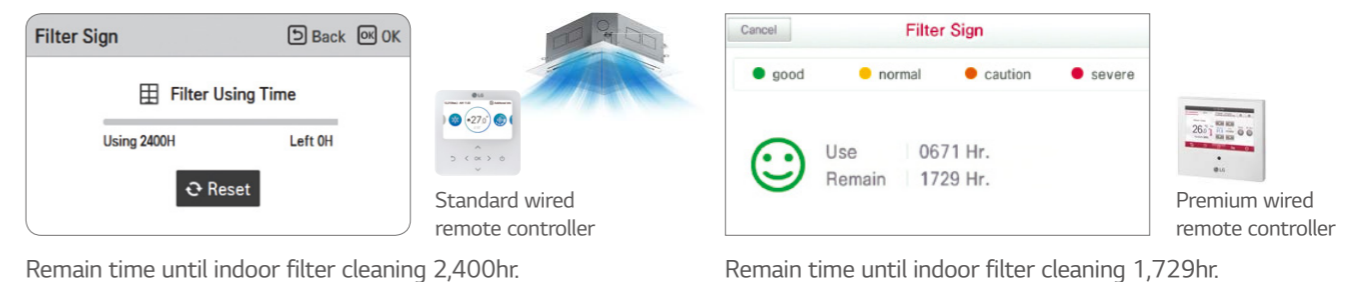

Remain time until indoor filter cleaning 2,400hr.

Remain time until indoor filter cleaning 1,729hr.

WALL MOUNTED UNIT



Features & Benefits

- 6 Different Discharge Angles can be Programmed via the Remote Control.
- Easily Detachable Full Surface Cover Helps Clean the Air Conditioner Flawlessly.
- Drain Pipe can be Easily Hidden from Sight.

Key Applications

- Retail
- Restaurant
- Office
- Hotel
- Multi-family Residence

	Wall Mounted Unit	Artcool Mirror	Artcool Gallery	Standard
Smart	Wi-Fi	○	○	○
Energy Efficiency	Energy Display	○	○	○
Fast Cooling & Heating	Jet Cool	○	○	○
	Auto Swing (Up & Down)	○	○	○
Health	Ionizer	○	-	○
	Pre Filter	○	○	○
	Auto Cleaning	○	○	○
Comfort	Sleep Mode	○	○	○
	Timer (On / Off)	○	○	○
	Timer (Weekly)	○	○	○
	Two Thermistor Control	○	○	○
	Group Control	○	○	○

※ ○: Applied, - : Not applied

Energy Display

LG's Energy Display panel monitors the amount of energy levels used. Save on energy consumption while enjoying the cooling by checking your energy level on the pane.

※ Specifications may vary for each model.

Magic Display & Remote Control

With the push of a button on the remote control, indoor unit's LCD display shows the current and total energy use, thus making the users aware of reducing energy consumption.

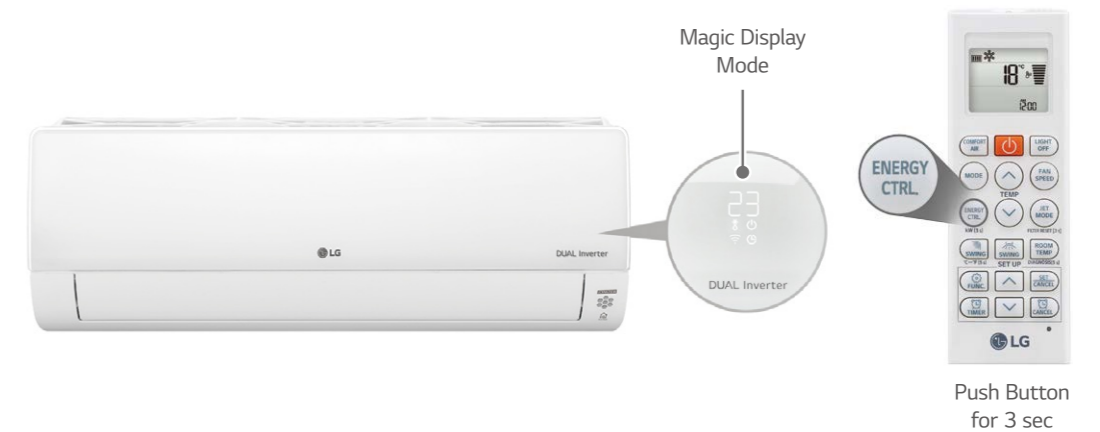

Normal Mode
Current Setting Temp.



Electric Power
Displays Current Energy Use



Fan Speed

Display	Speed
F5	High
F4	Medium-High
F3	Medium
F2	Medium-Low
F1	Low

Sleep Mode



For example, setting 1hr

WALL MOUNTED UNIT

4 Way Swing

Cool air reaches out to the entire room regardless of where the air conditioner is installed.

※ Specifications may vary for each model.

6-Step Vane, Control up to 70°

The vertical vane, which moves up and down, has 6 different settings including full swing.

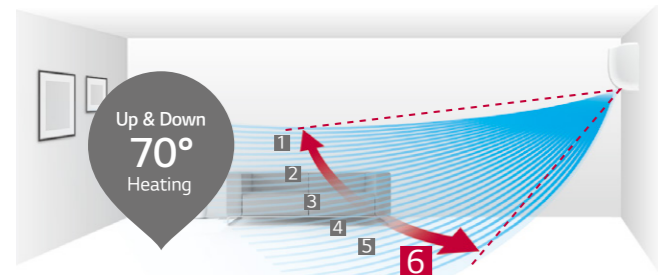

※ Angle can be different from each model and working mode.

Control up to 100°

The louver can be adjusted by manual.

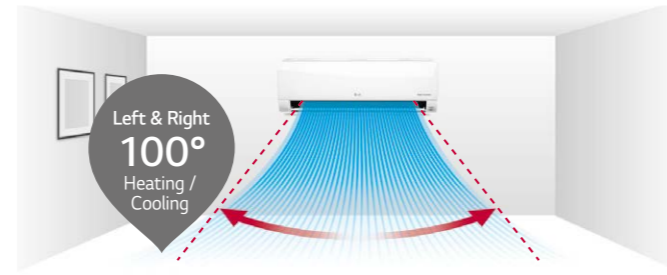

※ Angle can be different from each model and working mode.

Easy and Simple Control

Airflow direction can be changed by LG ThinQ Wi-Fi app.

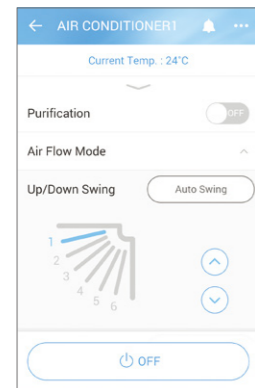

Up / Down Swing

Jet Cool

LG air conditioners provide optimized high-speed airflow, which can cool rooms faster while delivering cool air evenly in every direction.

※ Specifications may vary for each model.
 ※ Depending on the experimental conditions.

One Click "Jet Mode"

Reduces the temperature of outflowing air to 18°C for 30 minutes with just one click.



More Powerful Performance

By reducing the second vortex, which decreases airflow within the air outlet, and enlarging the fan size, the amount of airflow is increased to 13.0 CMM.

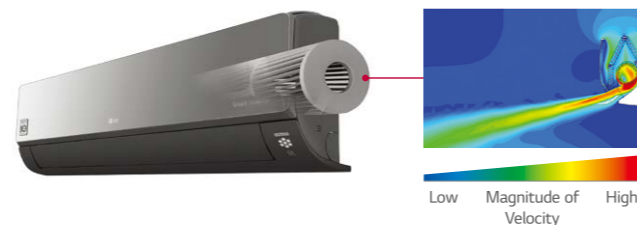

Ionizer PLUS

The powerful Ionizer protects you from bad odors and harmful and contagious particles in the air with over 3 million ions to sterilize not only the air passing through the air conditioner, but also surrounding surfaces for a safer, and cleaner environment.

※ Specifications may vary for each model.
 ※ Depending on the experimental conditions.

Sterilization and Deodorization (Utilizes Over 3 Million Ions)

Ionizer+ reduces harmful and contagious microscopic particles by infusing the air passing through the air conditioner with over 3 million ions.

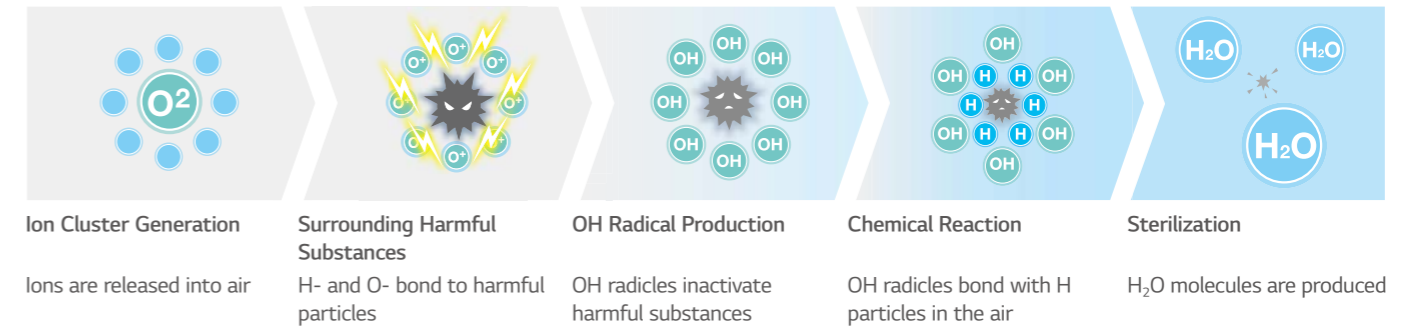

Sterilization Performance Evaluations

Sterilize Bacteria (E.coli colon bacillus) over 99.9% in 30 min.



※ Test Conditions : Space : 52m³ Chamber / Temperature & Humidity : Normal / Bacteria : Staphylococcus Aureus

2.1 odor strength decrease in 60 minutes

An odor of measured as 2 European odor units (ouE/m³) or less indicates that the level of odor falls within permissible limits

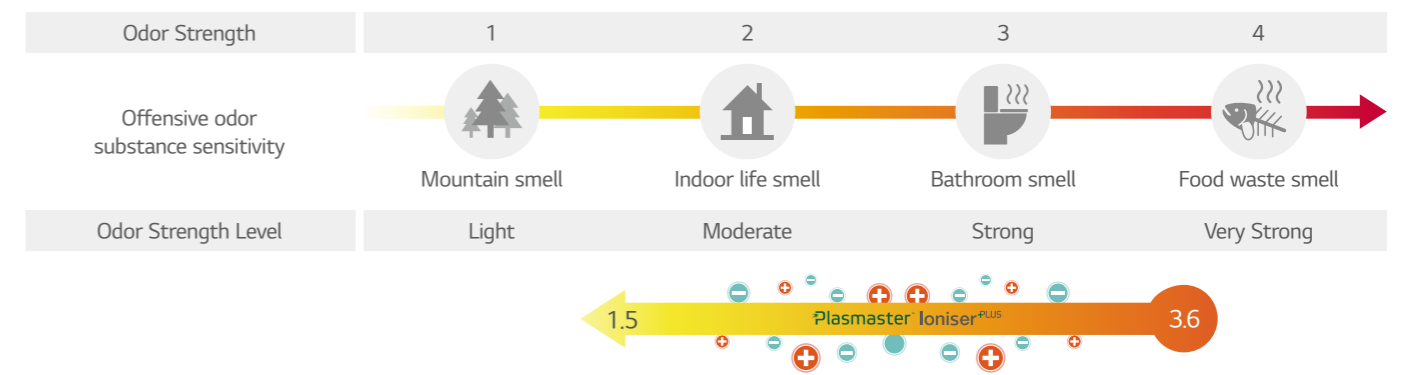

※ Odor strength reduce 3.6 → 1.5 / The Odor floating in the room as well as curtain and clothes.

WALL MOUNTED UNIT

Auto Cleaning

The interior of the air conditioner is maintained clean by drying off the heat exchanger, then sterilizing the interior once more.

Pain Point

The main cause of odor within air conditioners is mold and bacteria growing on the heat exchanger. These germs can spread when the heat exchanger is wet.



Cleans Filter with Regular Airflow

The comprehensive auto cleaning function prevents the formation of bacteria and mold on the heat exchanger, providing an enhancing environment.

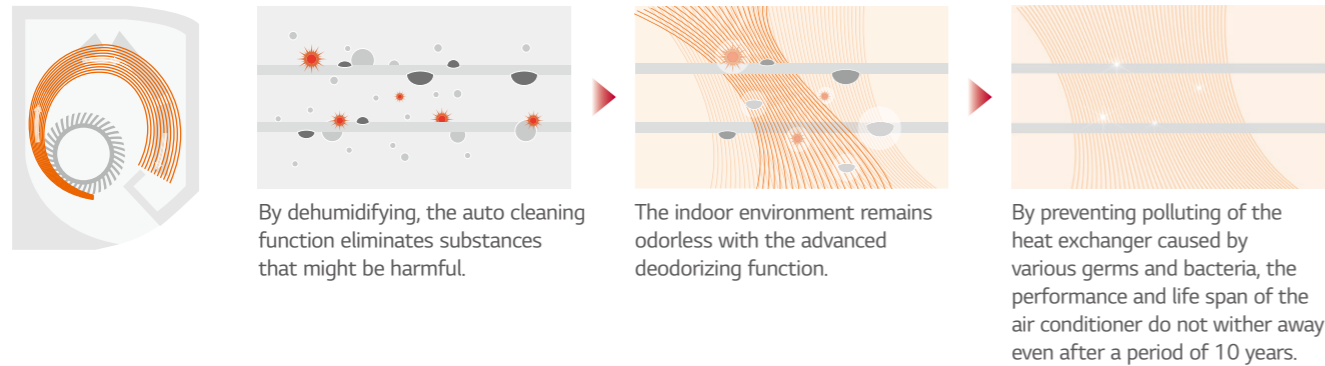

Removes Harmful Particles

Auto Cleaning provides clean air by preventing bacteria, mold and odors that can otherwise accumulate in an indoor unit.



Scheduled Operation

You can set the daily temperature, fan speed, the operation mode and automatic On / Off time for two weeks. It will keep running on that time until cancelled by the user or after setting period.

※ This function is for wired remote controller only.
 ※ Wired remote controller is need to be separately purchased.

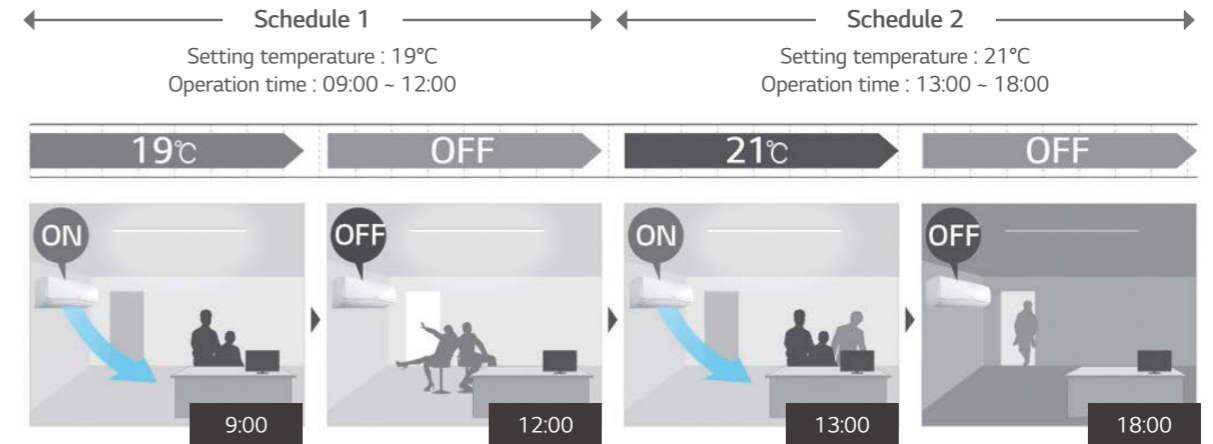

Two Thermistors Control

The indoor temperature can be checked using the thermistors in the remote controller as well as from the indoor unit. There may be a significant difference between ceiling and floor air temperature. Two thermistors can optimize indoor air temperature for a more comfortable environment.



Group Control

In case of group control, user can control much more function than conventional.

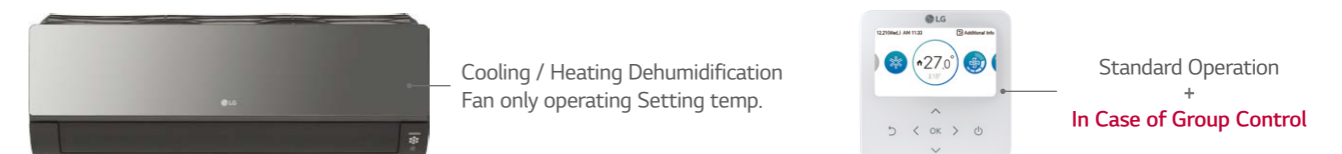

WALL MOUNTED UNIT

Quick & Easy Installation

LG air conditioner is designed for an easy and efficient installation, making possible to install several units in a short period of time.

※ Specifications may vary for each model.

One Simple Packing Box

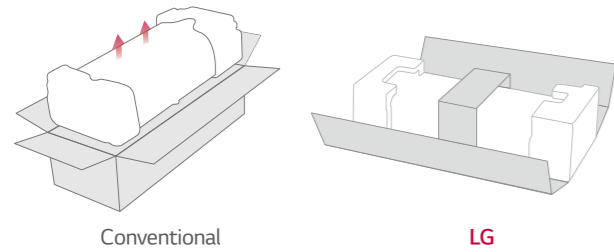

Installation Plate Improvement

LG's installation plate is larger and customized to reduce installation time.



Installation Support Clip

A support clip creates adequate space between the wall and the unit for easier installation.

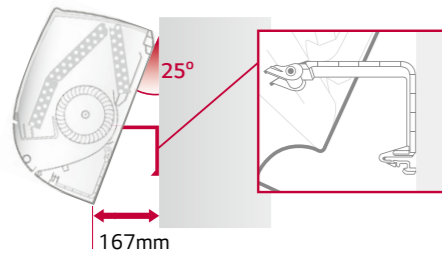

Wider Tubing Space

The space provided for tubing facilitates the whole installation process and hides the unorganized parts, making it appear clean and tidy.

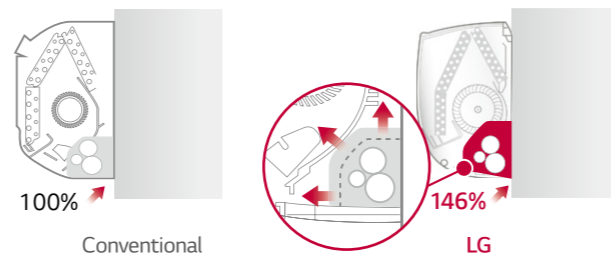

Detachable Bottom Cover

The air conditioner's bottom cover is detachable for easier installation and access.

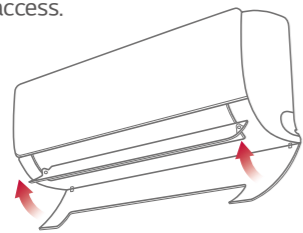

Quick button for running test

The test button is conveniently located and easy to find.

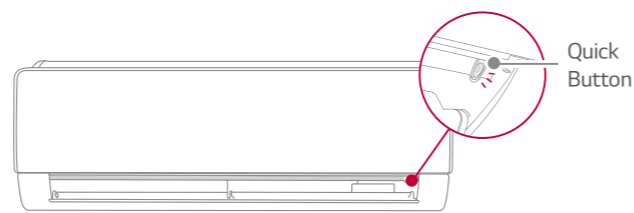

3 Way Flexible Installation

It is possible to install and connect the outdoor unit in 3 different ways (Left, Right, Back).

Back side view

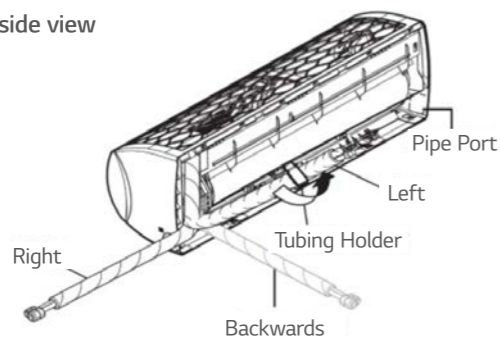

Wi-Fi Control

Control your air conditioners via using the smart internet devices as Android or iOS based smartphones. This advanced technology provides you the best convenience.

LG ThinQ



Search "LG ThinQ" on Google market or Appstore then download the app.

Integrated Home Appliances Control

Control / Monitor all your LG appliances from one place.



Access your air conditioner anytime and from anywhere with a Wi-Fi equipped device and LG's exclusive control app, LG ThinQ.



Easy Registration and Log-in

Follow the easy set-up steps that will activate LG ThinQ's impressive feature.

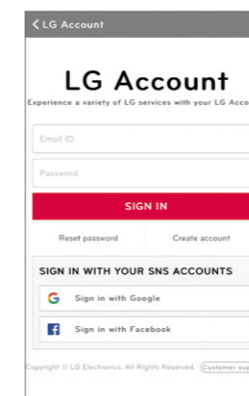

Wi-Fi Connectivity

Let's every member of your family choose their own preferred air conditioning temperature and fan speed, then save the settings in their app to run later. You can save the setting for each air conditioner as well.



※ Can be controlled by multiple users, but not simultaneously.

Simple operation for various functions

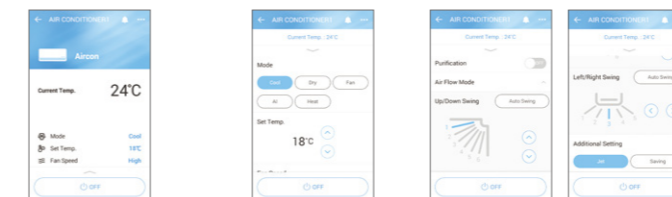

On / Off, Current Temp. Mode, Set Temp. Vane Control

Straight forward Management

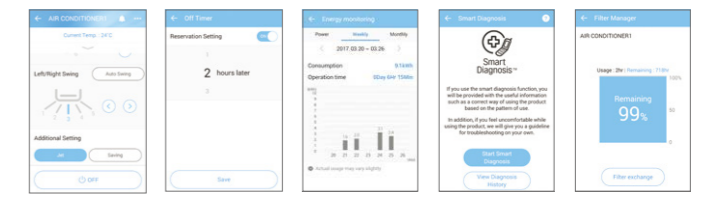

Reservation Energy Monitoring Smart Diagnosis Filter Management

ARTCOOL MIRROR

ARNU05GSJR4 / ARNU07GSJR4 / ARNU09GSJR4
ARNU12GSJR4 / ARNU15GSJR4



Model	Unit	ARNU05GSJR4	ARNU07GSJR4	ARNU09GSJR4	ARNU12GSJR4	ARNU15GSJR4	
Cooling Capacity	kW	1.6	2.2	2.8	3.6	4.5	
Heating Capacity	kW	1.8	2.5	3.2	4.0	5.0	
Power Input (H / M / L)	Nominal W	11 / 10 / 9	12 / 11 / 9	13 / 12 / 9	15 / 13 / 11	23 / 18 / 11	
Exterior Color		Mirror (Black)	Mirror (Black)	Mirror (Black)	Mirror (Black)	Mirror (Black)	
RAL Code		RAL 9005	RAL 9005	RAL 9005	RAL 9005	RAL 9005	
Dimensions (W x H x D)	Body	mm	837 x 308 x 192	837 x 308 x 192	837 x 308 x 192	837 x 308 x 192	
	Shipping	mm	909 x 383 x 256	909 x 383 x 256	909 x 383 x 256	909 x 383 x 256	
Fan	Type		Cross Flow Fan	Cross Flow Fan	Cross Flow Fan	Cross Flow Fan	
	Motor Output x Number	W x No.	30 x 1	30 x 1	30 x 1	30 x 1	
	Air Flow Rate (H / M / L)	m³/min	6.8 / 6.5 / 5.9	7.2 / 6.8 / 5.9	7.8 / 7.2 / 5.9	8.5 / 7.8 / 6.8	10.5 / 9.5 / 6.8
	Motor Type		BLDC	BLDC	BLDC	BLDC	BLDC
Air Filter		Pre Filter	Pre Filter	Pre Filter	Pre Filter	Pre Filter	
Pipe Connections	Liquid Side	mm (inch)	Ø6.35 (1/4)	Ø6.35 (1/4)	Ø6.35 (1/4)	Ø6.35 (1/4)	
	Gas Side	mm (inch)	Ø12.7 (1/2)	Ø12.7 (1/2)	Ø12.7 (1/2)	Ø12.7 (1/2)	
	Drain Pipe (Internal Dia.)	mm (inch)	Ø16 (5/8)	Ø16 (5/8)	Ø16 (5/8)	Ø16 (5/8)	
Weight	Body kg	9.2	9.2	9.2	9.2	9.2	
Sound Pressure Levels (H / M / L)	dB(A)	30 / 29 / 28	32 / 30 / 28	34 / 32 / 28	37 / 34 / 30	42 / 39 / 32	
Sound Power Levels (H / M / L)	dB(A)	54 / 53 / 52	54 / 53 / 52	55 / 54 / 52	55 / 54 / 53	58 / 56 / 54	
Power Supply	Ø, V, Hz	1, 220 - 240, 50	1, 220 - 240, 50	1, 220 - 240, 50	1, 220 - 240, 50	1, 220 - 240, 50	
		1, 220, 60	1, 220, 60	1, 220, 60	1, 220, 60	1, 220, 60	
Communication Cable	mm² x No.	1.0 - 1.5 x 2C	1.0 - 1.5 x 2C	1.0 - 1.5 x 2C	1.0 - 1.5 x 2C	1.0 - 1.5 x 2C	

※ Nominal : Performance tested under EN14511
 ※ Rated : Max. power input allowed for fan motor
 Note : 1. Capacities are based on the following conditions
 - Cooling : Indoor temp. 27°C (80.6°F) DB / 19°C (66.2°F) WB, Outdoor temp. 35°C (95°F) DB / 24°C (75.2°F) WB, Interconnecting piping length 7.5m, Level difference of zero
 - Heating : Indoor temp. 20°C (68°F) DB / 15°C (59°F) WB, Outdoor temp. 7°C (44.6°F) DB / 6°C (42.8°F) WB, Interconnecting piping length 7.5m, Level difference of zero
 2. Due to our policy of innovation some specifications may be changed without notification
 3. I.D : 'Internal Diameter'

Accessories

Chassis	ARNU05GSJR4	ARNU07GSJR4	ARNU09GSJR4	ARNU12GSJR4	ARNU15GSJR4
Drain Pump			-		
Cassette Cover			-		
Refrigerant Leakage Detector			PRLDNV50		
EEV Kit			PRGK024A0		
Independent Power Module			PRIP0		
Robot Cleaner			-		
Pre Filter (Washable / Anti-fungus)			○		
Ion Generator			○		
CO ₂ Sensor			-		
Ventilation Kit			-		
IR Receiver			-		
Zone Controller			-		
Dry Contact (with Additional Accessory)			PDRYCB000 (1 point contact) PDRYCB300 (8 points for thermostat compatible) NEW PDRYCB320 (Universal input) ¹⁾ PDRYCB400 (2 points input) PDRYCB500 (Modbus)		
External Input (1 point)			○		
Wi-Fi			○		

※ ○ : Applied, - : Not applied
 Option : Refer to model name in table
 1) Available from April 2020

ARNU18GSKR4 / ARNU24GSKR4



Model	Unit	ARNU18GSKR4	ARNU24GSKR4
Cooling Capacity	kW	5.6	7.1
Heating Capacity	kW	6.3	7.5
Power Input (H / M / L)	Nominal W	32 / 26 / 16	39 / 26 / 16
Exterior Color		Mirror (Black)	Mirror (Black)
RAL Code		RAL 9005	RAL 9005
Dimensions (W x H x D)	Body	mm	998 x 345 x 212
	Shipping	mm	1,080 x 422 x 281
Fan	Type		Cross Flow Fan
	Motor Output x Number	W x No.	58 x 1
	Air Flow Rate (H / M / L)	m³/min	14.0 / 12.0 / 10.5
	Motor Type		BLDC
Air Filter		Pre Filter	Pre Filter
Pipe Connections	Liquid Side	mm (inch)	Ø6.35 (1/4)
	Gas Side	mm (inch)	Ø12.7 (1/2)
	Drain Pipe (Internal Dia.)	mm (inch)	Ø16 (5/8)
Weight	Body kg	13.4	13.4
Sound Pressure Levels (H / M / L)	dB(A)	43 / 39 / 34	46 / 41 / 34
Sound Power Levels (H / M / L)	dB(A)	63 / 57 / 54	65 / 60 / 54
Power Supply	Ø, V, Hz	1, 220 - 240, 50	1, 220 - 240, 50
		1, 220, 60	1, 220, 60
Communication Cable	mm² x No.	1.0 - 1.5 x 2C	1.0 - 1.5 x 2C

※ Nominal : Performance tested under EN14511
 ※ Rated : Max. power input allowed for fan motor
 Note : 1. Capacities are based on the following conditions
 - Cooling : Indoor temp. 27°C (80.6°F) DB / 19°C (66.2°F) WB, Outdoor temp. 35°C (95°F) DB / 24°C (75.2°F) WB, Interconnecting piping length 7.5m, Level difference of zero
 - Heating : Indoor temp. 20°C (68°F) DB / 15°C (59°F) WB, Outdoor temp. 7°C (44.6°F) DB / 6°C (42.8°F) WB, Interconnecting piping length 7.5m, Level difference of zero
 2. Due to our policy of innovation some specifications may be changed without notification
 3. I.D : 'Internal Diameter'

Accessories

Chassis	ARNU18GSKR4	ARNU24GSKR4
Drain Pump		-
Cassette Cover		-
Refrigerant Leakage Detector		PRLDNV50
EEV Kit		PRGK024A0
Independent Power Module		PRIP0
Robot Cleaner		-
Pre Filter (Washable / Anti-fungus)		○
Ion Generator		○
CO ₂ Sensor		-
Ventilation Kit		-
IR Receiver		-
Zone Controller		-
Dry Contact (with Additional Accessory)		PDRYCB000 (1 point contact) PDRYCB300 (8 points for thermostat compatible) NEW PDRYCB320 (Universal input) ¹⁾ PDRYCB400 (2 points input) PDRYCB500 (Modbus)
External Input (1 point)		○
Wi-Fi		○

※ ○ : Applied, - : Not applied
 Option : Refer to model name in table
 1) Available from April 2020

ARTCOOL GALLERY

ARNU07GSF14 / ARNU09GSF14 / ARNU12GSF14

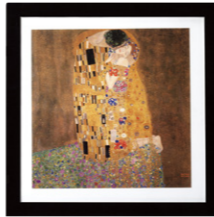

Model	Unit	ARNU07GSF14	ARNU09GSF14	ARNU12GSF14
Cooling Capacity	kW	2.2	2.8	3.6
Heating Capacity	kW	2.5	3.2	4.0
Power Input (H / M / L)	Nominal	W	28 / 16 / 10	28 / 16 / 10
				32 / 20 / 12
Dimensions (W x H x D)	Body	mm	600 x 600 x 146	600 x 600 x 146
	Shipping	mm	685 x 670 x 215	685 x 670 x 215
Fan	Type		Turbo Fan	Turbo Fan
	Motor Output x Number	W x No.	30 x 1	30 x 1
	Air Flow Rate (H / M / L)	m ³ /min	8.1 / 6.3 / 4.2	8.1 / 6.3 / 4.2
	Motor Type		BLDC	BLDC
Air Filter			Pre Filter	Pre Filter
Pipe Connections	Liquid Side	mm (inch)	Ø6.35 (1/4)	Ø6.35 (1/4)
	Gas Side	mm (inch)	Ø12.7 (1/2)	Ø12.7 (1/2)
	Drain Pipe (Internal Dia.)	mm (inch)	Ø12 (15/32)	Ø12 (15/32)
Weight	Body	kg	15.0	15.0
Sound Pressure Levels (H / M / L)		dB(A)	38 / 32 / 27	38 / 32 / 27
Sound Power Levels (H / M / L)		dB(A)	48 / 46 / 41	48 / 46 / 41
Power Supply	Ø, V, Hz		1, 220 - 240, 50	1, 220 - 240, 50
			1, 220, 60	1, 220, 60
Communication Cable		mm ² x No.	1.0 - 1.5 x 2C	1.0 - 1.5 x 2C

※ Nominal : Performance tested under EN14511

※ Rated : Max. power input allowed for fan motor

Note : 1. Capacities are based on the following conditions

- Cooling : Indoor temp. 27°C (80.6°F) DB / 19°C (66.2°F) WB, Outdoor temp. 35°C (95°F) DB / 24°C (75.2°F) WB, Interconnecting piping length 7.5m, Level difference of zero

- Heating : Indoor temp. 20°C (68°F) DB / 15°C (59°F) WB, Outdoor temp. 7°C (44.6°F) DB / 6°C (42.8°F) WB, Interconnecting piping length 7.5m, Level difference of zero

2. Due to our policy of innovation some specifications may be changed without notification

3. I.D : 'Internal Diameter'

Accessories

Chassis	ARNU07GSF14	ARNU09GSF14	ARNU12GSF14
Drain Pump		-	
Cassette Cover		-	
Refrigerant Leakage Detector		PRLDNVSO	
EEV Kit		PRGK024A0	
Independent Power Module		PRIP0	
Robot Cleaner		-	
Pre Filter (Washable / Anti-fungus)		○	
Ion Generator		-	
CO ₂ Sensor		-	
Ventilation Kit		-	
IR Receiver		-	
Zone Controller		-	
Dry Contact (with Additional Accessory)		PDRYCB000 (1 point contact) PDRYCB300 (8 points for thermostat compatible) NEW PDRYCB320 (Universal input) ¹⁾ PDRYCB400 (2 points input) PDRYCB500 (Modbus)	
External Input (1 point)		○	
Wi-Fi		PWFMD200 ²⁾	

※ ○ : Applied, - : Not applied

Option : Refer to model name in table

1) Available from April 2020

2) External installation only

STANDARD

ARNU05GSJ*4 / ARNU07GSJ*4 / ARNU09GSJ*4 / ARNU12GSJ*4 / ARNU15GSJ*4



Model	Unit	ARNU05GSJ*4	ARNU07GSJ*4	ARNU09GSJ*4	ARNU12GSJ*4	ARNU15GSJ*4
Cooling Capacity	kW	1.6	2.2	2.8	3.6	4.5
Heating Capacity	kW	1.8	2.5	3.2	4.0	5.0
Power Input (H / M / L)	Nominal	W	11 / 10 / 9	12 / 11 / 9	13 / 12 / 9	15 / 13 / 11
						23 / 18 / 11
Exterior Color		White	White	White	White	White
RAL Code		RAL 9016	RAL 9016	RAL 9016	RAL 9016	RAL 9016
Dimensions (W x H x D)	Body	mm	818 x 316 x 189	818 x 316 x 189	818 x 316 x 189	818 x 316 x 189
	Shipping	mm	892 x 381 x 249	892 x 381 x 249	892 x 381 x 249	892 x 381 x 249
Fan	Type		Cross Flow Fan	Cross Flow Fan	Cross Flow Fan	Cross Flow Fan
	Motor Output x Number	W x No.	30 x 1	30 x 1	30 x 1	30 x 1
	Air Flow Rate (H / M / L)	m ³ /min	6.8 / 6.5 / 5.9	7.2 / 6.8 / 5.9	7.8 / 7.2 / 5.9	8.5 / 7.8 / 6.8
	Motor type		BLDC	BLDC	BLDC	BLDC
Air Filter			Pre Filter	Pre Filter	Pre Filter	Pre Filter
Pipe Connections	Liquid Side	mm (inch)	Ø6.35 (1/4)	Ø6.35 (1/4)	Ø6.35 (1/4)	Ø6.35 (1/4)
	Gas Side	mm (inch)	Ø12.7 (1/2)	Ø12.7 (1/2)	Ø12.7 (1/2)	Ø12.7 (1/2)
	Drain Pipe (Internal Dia.)	mm (inch)	Ø16 (5/8)	Ø16 (5/8)	Ø16 (5/8)	Ø16 (5/8)
Weight	Body	kg	8.4	8.4	8.4	8.4
Sound Pressure Levels (H / M / L)		dB(A)	30 / 29 / 28	32 / 30 / 28	34 / 32 / 28	37 / 34 / 30
Sound Power Levels (H / M / L)		dB(A)	54 / 53 / 52	54 / 53 / 52	55 / 54 / 52	55 / 54 / 53
Power Supply	Ø, V, Hz		1, 220 - 240, 50	1, 220 - 240, 50	1, 220 - 240, 50	1, 220 - 240, 50
			1, 220, 60	1, 220, 60	1, 220, 60	1, 220, 60
Communication Cable		mm ² x No.	1.0 - 1.5 x 2C	1.0 - 1.5 x 2C	1.0 - 1.5 x 2C	1.0 - 1.5 x 2C

※ Nominal : Performance tested under EN14511

※ Rated : Max. power input allowed for fan motor

Note : 1. Capacities are based on the following conditions

- Cooling : Indoor temp. 27°C (80.6°F) DB / 19°C (66.2°F) WB, Outdoor temp. 35°C (95°F) DB / 24°C (75.2°F) WB, Interconnecting piping length 7.5m, Level difference of zero

- Heating : Indoor temp. 20°C (68°F) DB / 15°C (59°F) WB, Outdoor temp. 7°C (44.6°F) DB / 6°C (42.8°F) WB, Interconnecting piping length 7.5m, Level difference of zero

2. Due to our policy of innovation some specifications may be changed without notification

3. I.D : 'Internal Diameter'

* : N or C can be applied which has little bit different shape of panel.

Accessories

Chassis	ARNU05GSJ*4	ARNU07GSJ*4	ARNU09GSJ*4	ARNU12GSJ*4	ARNU15GSJ*4
Drain Pump		-			
Cassette Cover		-			
Refrigerant Leakage Detector		PRLDNVSO			
EEV Kit		PRGK024A0			
Independent Power Module		PRIP0			
Robot Cleaner		-			
Pre Filter (Washable / Anti-fungus)		○			
Ion Generator		-			
CO ₂ Sensor		-			
Ventilation Kit		-			
IR Receiver		-			
Zone Controller		-			
Dry Contact (with Additional Accessory)		PDRYCB000 (1 point contact) PDRYCB300 (8 points for thermostat compatible) NEW PDRYCB320 (Universal input) ¹⁾ PDRYCB400 (2 points input) PDRYCB500 (Modbus)			
External Input (1 point)		○			
Wi-Fi		○			

※ ○ : Applied, - : Not applied

Option : Refer to model name in table

1) Available from April 2020

STANDARD

ARNU18GSK*4 / ARNU24GSK*4



Model	Unit	ARNU18GSK*4	ARNU24GSK*4
Cooling Capacity	kW	5.6	7.1
Heating Capacity	kW	6.3	7.5
Power Input (H / M / L)	Nominal W	32 / 26 / 16	39 / 26 / 16
Exterior Color		White	White
RAL Code		RAL 9016	RAL 9016
Dimensions (W x H x D)	Body	mm	975 x 354 x 209
	Shipping	mm	1,063 x 420 x 274
Fan	Type		Cross Flow Fan
	Motor Output x Number	W x No.	58 x 1
	Air Flow Rate (H / M / L)	m ³ /min	14.0 / 12.0 / 10.5
	Motor type		BLDC
Air Filter		Pre Filter	Pre Filter
Pipe Connections	Liquid Side	mm (inch)	Ø6.35 (1/4)
	Gas Side	mm (inch)	Ø12.7 (1/2)
	Drain Pipe (Internal Dia.)	mm (inch)	Ø16 (5/8)
Weight	Body	kg	12.2
Sound Pressure Levels (H / M / L)	dB(A)	43 / 39 / 34	46 / 41 / 34
Sound Power Levels (H / M / L)	dB(A)	63 / 57 / 54	65 / 60 / 54
Power Supply	Ø, V, Hz	1, 220 - 240, 50	1, 220 - 240, 50
Communication Cable	mm ² x No.	1.0 - 1.5 x 2C	1.0 - 1.5 x 2C

※ Nominal : Performance tested under EN14511

※ Rated : Max. power input allowed for fan motor

Note : 1. Capacities are based on the following conditions

- Cooling : Indoor temp. 27°C (80.6°F) DB / 19°C (66.2°F) WB, Outdoor temp. 35°C (95°F) DB / 24°C (75.2°F) WB, Interconnecting piping length 7.5m, Level difference of zero

- Heating : Indoor temp. 20°C (68°F) DB / 15°C (59°F) WB, Outdoor temp. 7°C (44.6°F) DB / 6°C (42.8°F) WB, Interconnecting piping length 7.5m, Level difference of zero

2. Due to our policy of innovation some specifications may be changed without notification

3. I.D : 'Internal Diameter'

* : N or C can be applied which has little bit different shape of panel.

Accessories

Chassis	ARNU18GSK*4	ARNU24GSK*4
Drain Pump		-
Cassette Cover		-
Refrigerant Leakage Detector		PRLDNVSO
EEV Kit		PRGK024AO
Independent Power Module		PRIPO
Robot Cleaner		-
Pre Filter (Washable / Anti-fungus)		○
Ion Generator		○
CO ₂ Sensor		-
Ventilation Kit		-
IR Receiver		-
Zone Controller		-
Dry Contact (with Additional Accessory)		PDRYCB000 (1 point contact) PDRYCB300 (8 points for thermostat compatible) NEW PDRYCB320 (Universal input) ¹⁾ PDRYCB400 (2 points input) PDRYCB500 (Modbus)
External Input (1 point)		○
Wi-Fi		○

※ ○ : Applied, - : Not applied

Option : Refer to model name in table

1) Available from April 2020

ARNU30GSVA4 / ARNU36GSVA4



Model	Unit	ARNU30GSVA4	ARNU36GSVA4
Cooling Capacity	kW	8.8	10.4
Heating Capacity	kW	9.4	10.8
Power Input (H / M / L)	Nominal W	54 / 43 / 31	85 / 51 / 36
Exterior Color		White	White
RAL Code		RAL 9016	RAL 9016
Dimensions (W x H x D)	Body	mm	1,190 x 346 x 265
	Shipping	mm	1,265 x 432 x 335
Fan	Type		Cross Flow Fan
	Motor Output x Number	W x No.	113 x 1
	Air Flow Rate (H / M / L)	m ³ /min	23.0 / 20.0 / 17.0
	Motor type		BLDC
Air Filter		Pre Filter	Pre Filter
Pipe Connections	Liquid Side	mm (inch)	Ø9.52 (3/8)
	Gas Side	mm (inch)	Ø15.88 (5/8)
	Drain Pipe (Internal Dia.)	mm (inch)	Ø16 (5/8)
Weight	Body	kg	16.6
Sound Pressure Levels (H / M / L)	dB(A)	49 / 44 / 42	52 / 47 / 43
Power Supply	Ø, V, Hz	1, 220 - 240, 50	1, 220 - 240, 50
Communication Cable	mm ² x No.	1.0 - 1.5 x 2C	1.0 - 1.5 x 2C

※ Nominal : Performance tested under EN14511

※ Rated : Max. power input allowed for fan motor

Note : 1. Capacities are based on the following conditions

- Cooling : Indoor temp. 27°C (80.6°F) DB / 19°C (66.2°F) WB, Outdoor temp. 35°C (95°F) DB / 24°C (75.2°F) WB, Interconnecting piping length 7.5m, Level difference of zero

- Heating : Indoor temp. 20°C (68°F) DB / 15°C (59°F) WB, Outdoor temp. 7°C (44.6°F) DB / 6°C (42.8°F) WB, Interconnecting piping length 7.5m, Level difference of zero

2. Due to our policy of innovation some specifications may be changed without notification

3. I.D : 'Internal Diameter'

Accessories

Chassis	ARNU30GSVA4	ARNU36GSVA4
Drain Pump		-
Cassette Cover		-
Refrigerant Leakage Detector		PRLDNVSO
EEV Kit		-
Independent Power Module		PRIPO
Robot Cleaner		-
Pre Filter (Washable / Anti-fungus)		○
Ion Generator		-
CO ₂ Sensor		-
Ventilation Kit		-
IR Receiver		-
Zone Controller		-
Dry Contact (with Additional Accessory)		PDRYCB000 (1 point contact) PDRYCB300 (8 points for thermostat compatible) NEW PDRYCB320 (Universal input) ¹⁾ PDRYCB400 (2 points input) PDRYCB500 (Modbus)
External Input (1 point)		○
Wi-Fi		PWFMD200 ¹⁾

※ ○ : Applied, - : Not applied

Option : Refer to model name in table

1) Available from April 2020

2) External installation only

SMART DUAL VANE CASSETTE



Features & Benefits

- 6 Different Discharge Angles can be Programmed via the Remote Control.
- Easily Detachable Full Surface Cover Helps Clean the Air Conditioner Flawlessly.
- Drain Pipe can be Easily Hidden from Sight.

Key Applications

- Retail
- Restaurant
- Office
- Hotel
- Dormitory
- Restaurant

New Design

Dual vane designs new air flow

Air flow certified by the NET(New Excellent Technology) provides comfortable and convenient feeling.

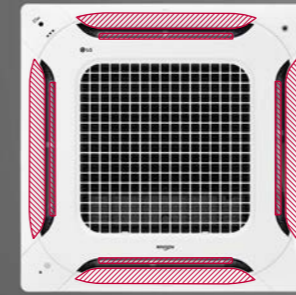

Smart 4Way Dual Vane



Brighter Color

White color looks better on the ceiling.



Wide Design

Bigger inlet and outlet make faster cooling / heating airflow.

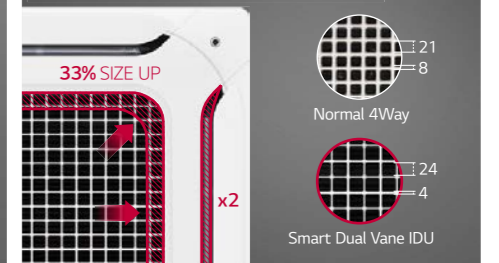

High Air flow & Low noise with Full 3D Fan

Full 3D fan decreases air resistance, makes High Airflow and Low Sound Level.

Normal 3D FAN		Full 3D FAN	
Sound (Turbo)	48 dB(A)	Sound (Turbo)	45 dB(A)
Sound (Low)	42 dB(A)	Sound (Low)	39 dB(A)
Power Input	102 W	Power Input	89 W

High Efficient Heat Exchanger (HEX)

Ø5 High Density Heat Exchanger makes 10% cooling / heating efficiency.







Normal Ø7 HEX		High Efficient Ø5 HEX	
Heat Transfer Area	3.32m ² (100%)	Heat Transfer Area	3.45m ² (104%)
Tube Column	12 Column	Tube Column	18 Column
Fin per Inch	19	Fin per Inch	21
Efficiency	100%	Efficiency	110%

SMART DUAL VANE CASSETTE

Various Airflow

Dual Vane leads the new types wind

Innovative dual vane designs each of the best airflow over various spaces.

 <p>Fast and Quick Power Cooling</p>	 <p>Fresh and Natural Up / Down swing</p>	 <p>Auto Vane Control Smart mode</p>
 <p>Indirect cooling & Heating Indirect wind</p>	 <p>No need extra high ceiling kits Direct wind</p>	 <p>Provide high concentration Refresh mode</p>

Power Cooling

Powerful airflow is always faster cooling and heating (4 Vane Control Logic).



Reached time to set temperature

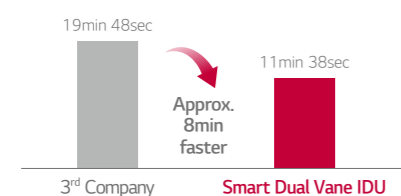

<Beginning Temperature 31°C, Approaching temperature 26°C>

※ Smart Dual Vane Indoor Unit 14.5kW
 ※ Data Based on actual test of LG Test Chamber, single product test result (start temp. : 33°C, Setting Temp. : 26 °C, 3rd Company : Cooling Autoswing, LG : Natural Dual Swing Mode)

Up / Down swing

Up / Down swing provides fresh and uniform airflow (Dual Swing).



Cooling Temperature Distribution rate

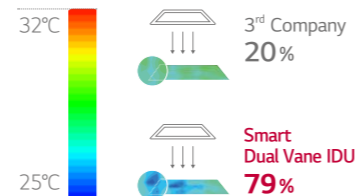

<3rd company Auto swing, LG Dual auto swing mode>

※ Smart Dual Vane Indoor Unit 14.5kW
 ※ Data Based on actual test of LG Test Chamber, single product test result (start temp. : 33°C, Setting Temp. : 26 °C, 3rd Company : Cooling Autoswing, LG : Natural Dual Swing Mode)

Smart mode

IDU automatically controls power and indirect wind to keep feeling good. (Power → Reached Setting Temp. → Indirect Airguide → Unreached Setting Temp. → Power)



Change of airflow by Temperature

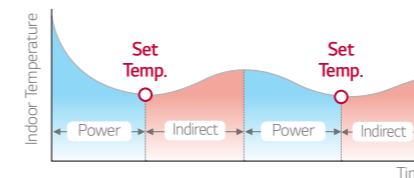

Indirect wind

Dual Vane designs indirect wind without separate airguide Kit.



Direct wind

No need high ceiling kit, and airflow is controlled to reach the floor by angles of vane. (3rd Company : Single Vane 70°, LG High Ceiling : Dual Vane 85°)



Comparison of flow height

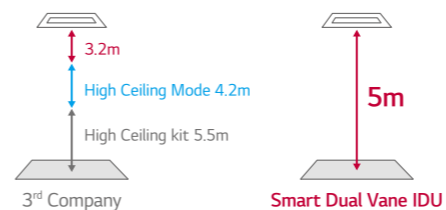

※ 3rd Company : High Ceiling Installation Kit Manual, LG : Direct wind

Refresh mode

IDU controls temperature and air flow to induce brainwave change, so that it provides high concentration.

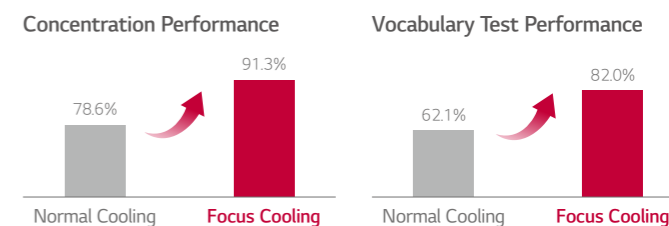

※ Data based on the results of EEG measurements through the sleep polysomnography in Seoul Sleep Environment Research.

SMART DUAL VANE CASSETTE

Various Airflow

Human detecting Direct / Indirect airflow

Human sensing function finds users to provide their favorite airflow.

Comfort Indirect

Prevent airflow to heading to user by sensing.



No touch
Indirect airflow
Comfort

Follow user Direct

Prefer air flow to heading to user by sensing.



Direct airflow
2°C Cooler

※ Available only for products with Human Detecting sensor.

Everyday High performance of Air cleaning

Air cleaning function makes clean spaces for everyday.



Air Cleaning Area
150.9 m²

Clean Air Delivery Rate (CADR)
19.6 m³/min

What is the CADR?

CADR is an universe figure of merit that is cubic feet per minute (CFM) of air that has had all the particles of a given size distribution removed.

CADR (Clean Air Delivery Rate)

※ Korean Air Cleaning Association Certification Standards (Jun, 2019)

Human detecting On / Off Learning operation system

IDU senses people to switch On / Off for Max. 54% power saving.

Operation On



In office

Turning Off

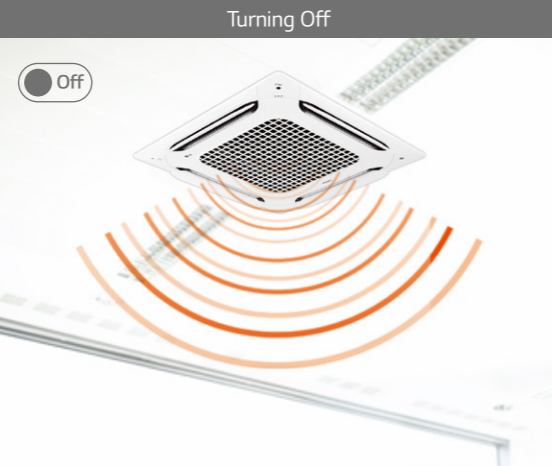

Absence

Turning On



In office

Learning time for Power saving
Manageable set time 30min / 60min / 90min

5min Absence → Turn off after 30min (Set turn off)
Learning time for Absence

↑ 2°C, running 25min (If set time 30min) | **Power saving**

Max. **54%**
Power saving

※ Data Based on actual test of LG, single product 2 hours measurement result. (cooling 26°C, strong wind)

Convenient and Powerful 5 Steps Air cleaning

Easy to manage air cleaning system with one-touch air cleaning filter.

Air cleaning kit

- Antibacterial kit
- Photocatalytic Deodorizing filter
- Dielectric Dust collecting filter

Dust electrification



Cycle / Management

Phase 5 Antibacterial Kit	No need
Phase 4 Deodorizing Filter	6 months / Dry
Phase 3 Ultra Fine Dust Kit	6 months / Washable
Phase 2 Dust Electrification	-

Air cleaning panel

- Pre-filter
- PM 1.0 Dust Sensor**
- Electrical diffusion makes dustelectrification.
- Air condition LED Status**

Phase 1 | Pre-filter

Easy removable pre-filter

SMART DUAL VANE CASSETTE

ARNU24GTBB4 / ARNU28GTBB4 / ARNU30GTBB4



Model	Unit	ARNU24GTBB4	ARNU28GTBB4	ARNU30GTBB4	
Cooling Capacity	kW	7.1	8.2	9.0	
	kcal/h	6,100	7,100	7,700	
	Btu/h	24,200	28,000	30,700	
Heating Capacity	kW	8.0	9.2	10.0	
	kcal/h	6,900	8,000	8,600	
	Btu/h	27,300	31,500	34,100	
Casing		Galvanized Steel Plate	Galvanized Steel Plate	Galvanized Steel Plate	
Dimensions (W x D x H)	Body	mm	840 x 840 x 204	840 x 840 x 204	
		inch	33.0 x 33.0 x 8	33.0 x 33.0 x 8	
	Front Panel	mm	950 x 950 x 35	950 x 950 x 35	
		inch	37.4 x 37.4 x 1.3	37.4 x 37.4 x 1.3	
Coil	Rows x Columns x FPI	3 x 8 x 21	3 x 8 x 21	3 x 8 x 21	
	Face Area	m ²	0.33	0.33	
Fan	Type	Full 3D Turbo Fan	Full 3D Turbo Fan	Full 3D Turbo Fan	
	Motor Output x Number	W	51 x 1	51 x 1	
	Running Current	A	0.31	0.34	
	Air Flow Rate (H / M / L)	CMM	18 / 17 / 15	19 / 17 / 15	21 / 19 / 16
		cfm	635 / 600 / 530	671 / 600 / 530	741 / 681 / 565
	Drive		Direct	Direct	
	Motor Type		BLDC	BLDC	
Temperature Control		Microprocessor, Thermostat for cooling and heating			
Sound Absorbing Thermal Insulation Material		Foamed polystyrene	Foamed polystyrene	Foamed polystyrene	
Safety Device		Fuse	Fuse	Fuse	
Pipe Connections	Liquid Side	mm (inch)	Ø9.52 (3/8)	Ø9.52 (3/8)	
	Gas Side	mm (inch)	Ø15.88 (5/8)	Ø15.88 (5/8)	
	Drain Pipe (Internal Dia.)	mm (inch)	25 (1)	25 (1)	
Net Weight	Body	kg(lbs)	21 (46.3)	21 (46.3)	
Noise Level (Sound Press, 1.5m, H / M / L)		dB(A)	39 / 37 / 35	40 / 38 / 35	
				43 / 40 / 36	
Power Supply		∅, V, Hz	1, 220 - 240, 50	1, 220 - 240, 50	
			1, 220, 60	1, 220, 60	
Refrigerant Control		EEV	EEV	EEV	
Power Cord		H05RN-F 1.5 x 3C	H05RN-F 1.5 x 3C	H05RN-F 1.5 x 3C	
Transmission Cable		CVV-SB 1.25 x 2C	CVV-SB 1.25 x 2C	CVV-SB 1.25 x 2C	
Panel Color		Noble White (RAL 9003)	Noble White (RAL 9003)	Noble White (RAL 9003)	
Panel Name (Accessory)		PT-AAGW0 / PT-AFGW0	PT-AAGW0 / PT-AFGW0	PT-AAGW0 / PT-AFGW0	
Power Input	Cooling (Rate)	W	32 / 27 / 20	37 / 30 / 22	
	Heating (Rate)	W	32 / 27 / 20	37 / 30 / 22	
Current Input	Cooling (Rate)	A	0.31 / 0.26 / 0.21	0.34 / 0.28 / 0.22	
	Heating (Rate)	A	0.31 / 0.26 / 0.21	0.34 / 0.28 / 0.22	

* Available from may 2020

ARNU36GTAB4 / ARNU42GTAB4 / ARNU48GTAB4



Model	Unit	ARNU36GTAB4	ARNU42GTAB4	ARNU48GTAB4	
Cooling Capacity	kW	10.6	12.3	14.1	
	kcal/h	9,100	10,600	12,100	
	Btu/h	36,200	42,000	48,100	
Heating Capacity	kW	11.9	13.8	15.9	
	kcal/h	10,200	11,000	13,200	
	Btu/h	40,600	43,800	51,200	
Casing		Galvanized Steel Plate	Galvanized Steel Plate	Galvanized Steel Plate	
Dimensions (W x D x H)	Body	mm	840 x 840 x 288	840 x 840 x 288	
		inch	33.0 x 33.0 x 11.3	33.0 x 33.0 x 11.3	
	Front Panel	mm	950 x 950 x 35	950 x 950 x 35	
		inch	37.4 x 37.4 x 1.3	37.4 x 37.4 x 1.3	
Coil	Rows x Columns x FPI	3 x 12 x 21	3 x 12 x 21	3 x 12 x 21	
	Face Area	m ²	0.5	0.5	
Fan	Type	Full 3D Turbo Fan	Full 3D Turbo Fan	Full 3D Turbo Fan	
	Motor Output x Number	W	135 x 1	135 x 1	
	Running Current	A	0.62	0.85	
	Air Flow Rate (H / M / L)	CMM	29 / 26 / 22	33 / 29 / 26	34 / 30 / 28
		cfm	1,024 / 918 / 777	1,165 / 1,024 / 918	1,200 / 1,059 / 988
	Drive		Direct	Direct	
	Motor Type		BLDC	BLDC	
Temperature Control		Microprocessor, Thermostat for cooling and heating			
Sound Absorbing Thermal Insulation Material		Foamed polystyrene	Foamed polystyrene	Foamed polystyrene	
Safety Device		Fuse	Fuse	Fuse	
Pipe Connections	Liquid Side	mm (inch)	Ø9.52 (3/8)	Ø9.52 (3/8)	
	Gas Side	mm (inch)	Ø15.88 (5/8)	Ø15.88 (5/8)	
	Drain Pipe (Internal Dia.)	mm (inch)	25 (1)	25 (1)	
Net Weight	Body	kg(lbs)	26 (57.3)	26 (57.3)	
Noise Level (Sound Press, 1.5m, H / M / L)		dB(A)	43 / 40 / 37	47 / 43 / 40	
				48 / 44 / 42	
Power Supply		∅, V, Hz	1, 220 - 240, 50	1, 220 - 240, 50	
			1, 220, 60	1, 220, 60	
Refrigerant Control		EEV	EEV	EEV	
Power Cord		H05RN-F 1.5 x 3C	H05RN-F 1.5 x 3C	H05RN-F 1.5 x 3C	
Transmission Cable		CVV-SB 1.25 x 2C	CVV-SB 1.25 x 2C	CVV-SB 1.25 x 2C	
Panel Color		Noble White (RAL 9003)	Noble White (RAL 9003)	Noble White (RAL 9003)	
Panel Name (Accessory)		PT-AAGW0 / PT-AFGW0	PT-AAGW0 / PT-AFGW0	PT-AAGW0 / PT-AFGW0	
Power Input	Cooling (Rate)	W	69 / 49 / 37	97 / 69 / 49	
	Heating (Rate)	W	69 / 49 / 37	97 / 69 / 49	
Current Input	Cooling (Rate)	A	0.62 / 0.46 / 0.36	0.85 / 0.62 / 0.46	
	Heating (Rate)	A	0.62 / 0.46 / 0.36	0.85 / 0.62 / 0.46	

* Available from may 2020

ROUND CASSETTE



Features & Benefits

- Premium design to match your interior space
- Pleasant airflow for optimal comfort
- Air purification
- Improved and simple installation

Key Applications

- Retail
- School
- Office
- Hotel
- Dormitory
- Restaurant

Premium Design to Complete the Space

Subtly revealed elegance. Sense that stands out in any interior. A body design that naturally fits your space, adding class to your style. Panels styled with clean whites and modern blacks, perfecting your interior.



Comfort

Perfect Round Flow

Perfect round flow without blind spots. (This product can only be installed on an open ceiling)



Visible, Intuitive Airflow

With crystal vane for 6-step precision control, you can send cool / heated air wherever you want.

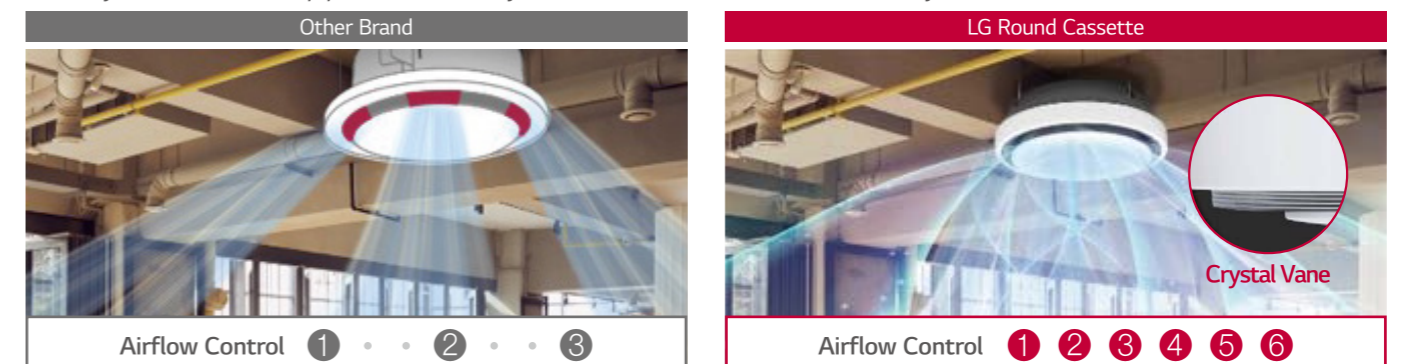

ROUND CASSETTE

Comfort

30% Faster in Cooling

With greater airflow, it gets cooler 30% faster, spreading cool air evenly without missing a spot.

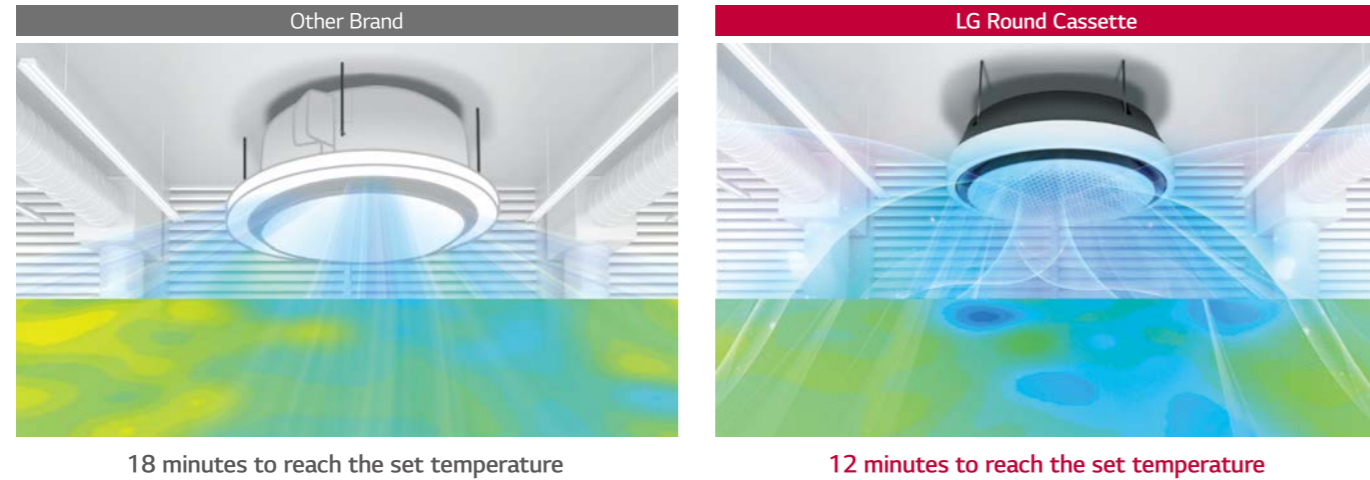

Clean Air

Powerful and Convenient 5-step Air Purification

With the semi-permanent 5-step air filter, you don't have to worry about maintenance cost anymore.



Installation

Minimal exposure of installations

Pipes are brought together in one place to minimize exposure. Hanger covers hide installations to add a clean, sophisticated look. (This product can only be installed on an open ceiling)

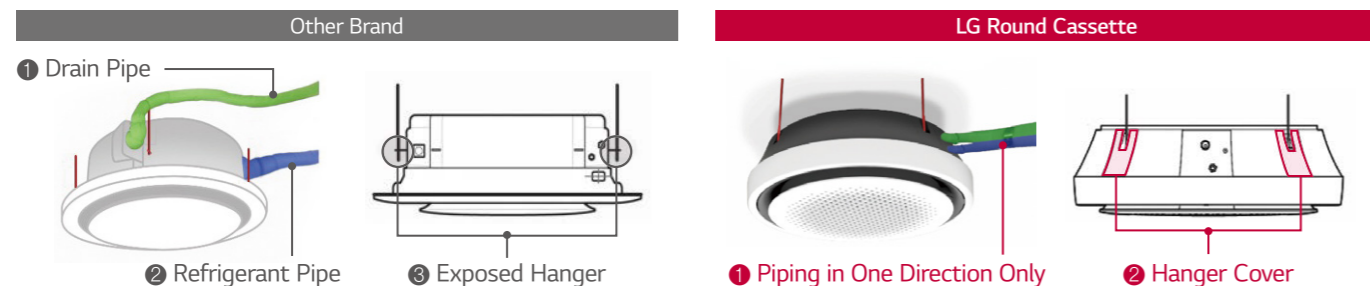

ROUND CASSETTE

ARNU24GTYA4 / ARNU36GTYA4 / ARNU48GTYA4



Model	Unit	ARNU24GTYA4	ARNU36GTYA4	ARNU48GTYA4	
Cooling Capacity	Rated	kW	7.1	10.6	14.1
		Btu/h	24,200	36,200	48,100
Heating Capacity	Rated	kW	8.0	11.9	15.9
		Btu/h	27,300	40,600	54,200
Power Input	H / M / L	W	44 / 36 / 29	63 / 47 / 36	98 / 70 / 44
Running Current	H / M / L	A	0.47 / 0.40 / 0.32	0.67 / 0.52 / 0.40	0.99 / 0.74 / 0.47
Indoor Fan	Type	-	3D Turbo Fan	3D Turbo Fan	3D Turbo Fan
	Air Flow Rate (H / M / L)	m ³ /min	22 / 21 / 19	27 / 24 / 21	32 / 28 / 23
Indoor Fan Motor	Type	-	Brushless DC	Brushless DC	Brushless DC
	Drive	-	Direct	Direct	Direct
	Output	W x No.	157 x 1	157 x 1	157 x 1
	FLA (Full Load Ampere)	A	1.97	1.97	1.97
Heat Exchanger	(Rows x Columns x FPI) x No.	-	(3 x 12 x 21) x 1	(3 x 12 x 21) x 1	(3 x 12 x 21) x 1
	Face Area	m ²	0.5	0.5	0.5
Dimensions	Net (W x H x D)	mm	1,050 x 330 x 1,050	1,050 x 330 x 1,050	1,050 x 330 x 1,050
	Shipping (W x H x D)	mm	1,137 x 395 x 1,132	1,137 x 395 x 1,132	1,137 x 395 x 1,132
Weight	Net	kg	30.0	30.0	30.0
	Shipping	kg	37.9	37.9	37.9
Exterior	Color (RAL Code)	-	White (9003)	White (9003)	White (9003)
Air Filter	Type	-	Long life	Long life	Long life
Temperature Control	-	Microprocessor, Thermostat for cooling and heating			
Sound Absorbing / Thermal Insulation Material	-	Foamed polystyrene			
Protection Device	-	Fuse	Fuse	Fuse	
Refrigerant	Type	-	R410A	R410A	R410A
	Control Type	-	EEV	EEV	EEV
Drain Pipe	O.D / I.D	mm (inch)	32 / 25	32 / 25	32 / 25
	Liquid	mm (inch)	Ø9.52 (3/8)	Ø9.52 (3/8)	Ø9.52 (3/8)
Piping Connection	Gas	mm (inch)	Ø15.88 (5/8)	Ø15.88 (5/8)	Ø15.88 (5/8)
	Connection Type (Liquid)	-	Flare	Flare	Flare
	Connection Type (Gas)	-	Flare	Flare	Flare
	Sound Pressure Level	Cooling (H / M / L)	dB(A)	39 / 37 / 34	43 / 39 / 37
Sound Power Level	Heating (H / M / L)	dB(A)	39 / 37 / 34	43 / 39 / 37	47 / 44 / 39
	Cooling (H / M / L)	dB(A)	48 / 46 / 43	52 / 48 / 46	56 / 53 / 48
Power Supply	Heating (H / M / L)	dB(A)	48 / 46 / 43	52 / 48 / 46	56 / 53 / 48
	-	Ø, V, Hz	1, 220 - 230 - 240, 50/60	1, 220 - 230 - 240, 50/60	1, 220 - 230 - 240, 50/60
Connecting Cable	Running Current by voltage	A	0.47 - 0.45 - 0.43	0.67 - 0.64 - 0.61	0.99 - 0.95 - 0.91
	Communication Cable (VCTF-SB)	mm ² x cores	1.0 - 1.5 x 2C	1.0 - 1.5 x 2C	1.0 - 1.5 x 2C

※ Panel integrated product
 ※ This product can only be installed on an open ceiling

CEILING MOUNTED CASSETTE



Features & Benefits

- Human detection control allowing energy savings through saving operation & comfort through wind direction operation
- New multi-functional 4 Way cassette panel for large sizes with aesthetic shape
- The independent vane operation feature allows user to control vanes by desired and perceptible comfort flow

Key Applications

- Retail
- School
- Office
- Hotel
- Dormitory
- Restaurant

Cassette		4 Way	2 Way	1 Way
Smart	Wi-Fi	○	○	○
Energy Efficiency	Human Detect Sensor	○	-	-
Health	Auto Cleaning	-	○	-
Comfort	Drain Pump	○	○	○
	Sleep Mode	○	○	○
	Timer (On / Off)	○	○	○
	Timer (Weekly)	○	○	○
	Two Thermistor Control	○	○	○
	Group Control	○	○	○

※ ○ : Applied, - : Not applied

Human Detect Sensor & Humidity Sensor

The interior of the air conditioner is maintained clean by drying off the heat exchanger, then sterilizing the interior once more.

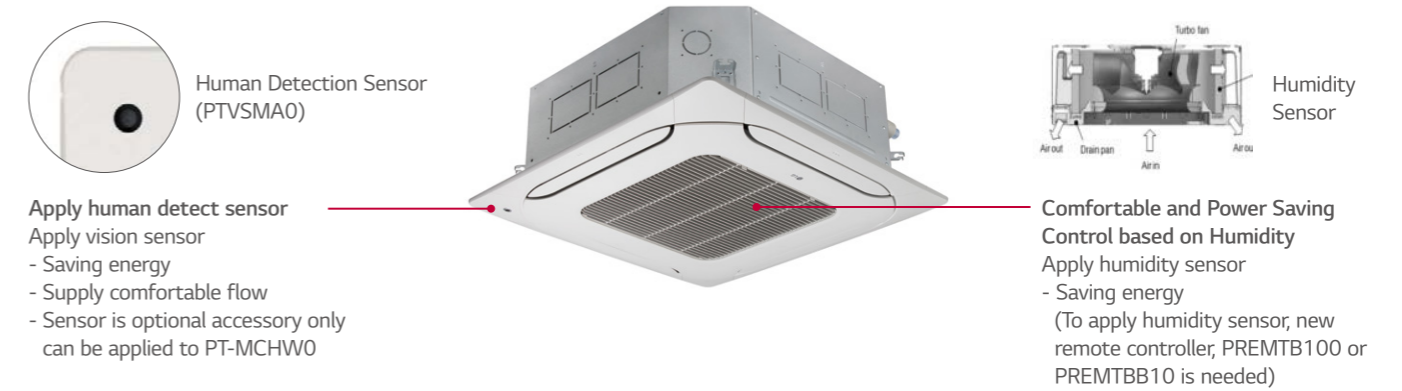

Direction control based on human motion

Air flow direction is controlled automatically by motion sensor that detects the activity of people every 10 seconds.

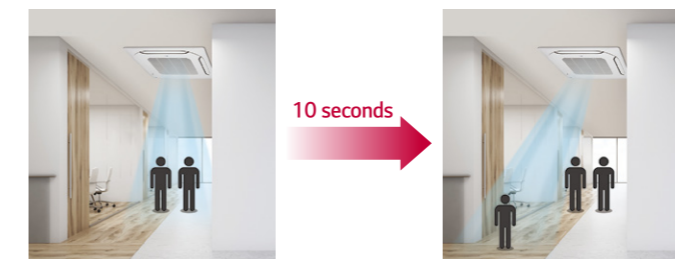

Detection range

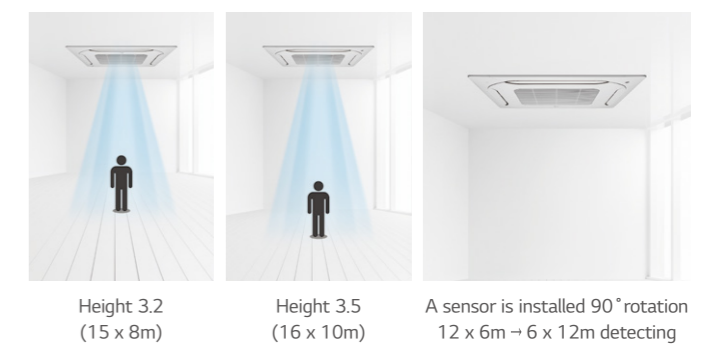

On / Off mode

The indoor unit automatically stops when detecting absence. It runs as the usual mode when sensing human body.

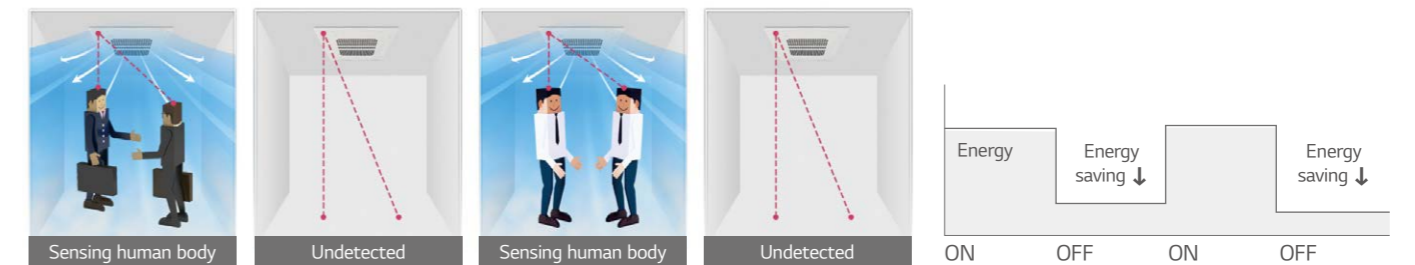

Temperature control mode

Energy savings by automatically setting target temperature during absence. (5 / 10 / 15 / 30 / 60min)



CEILING MOUNTED CASSETTE

Quick Control

4th Generation indoor unit offers rapid heating and cooling about 10times faster than conventional through communication mode change and improved communication speed.

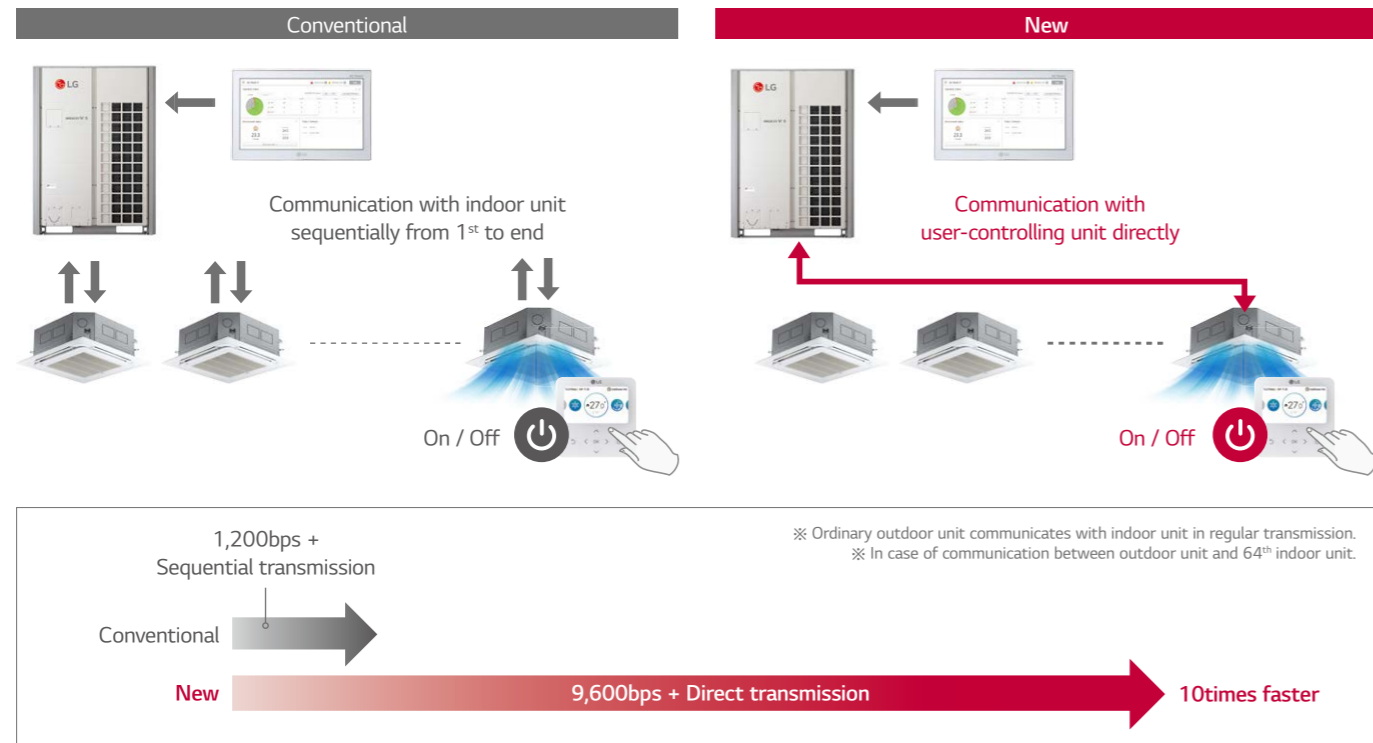

Independent Vane Control

The Independent Vane Operation feature uses separate motors, making it possible to control all four vanes independently.

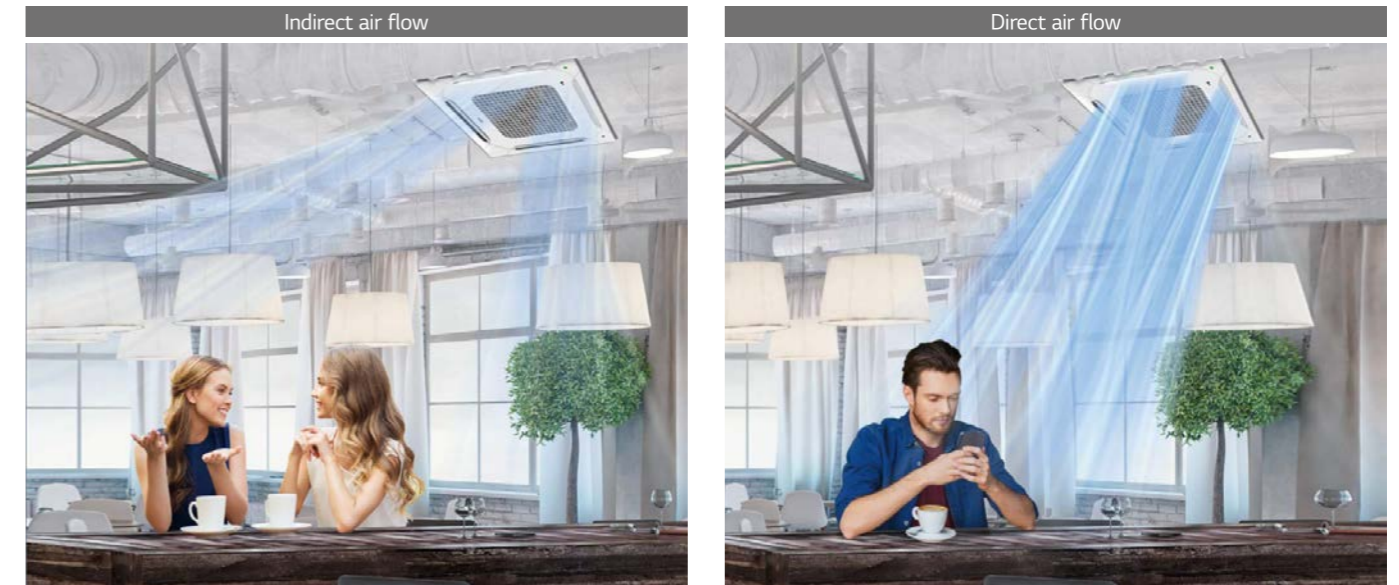

INDOOR UNITS

Group Control

In case of group control, user can control much more function than conventional.

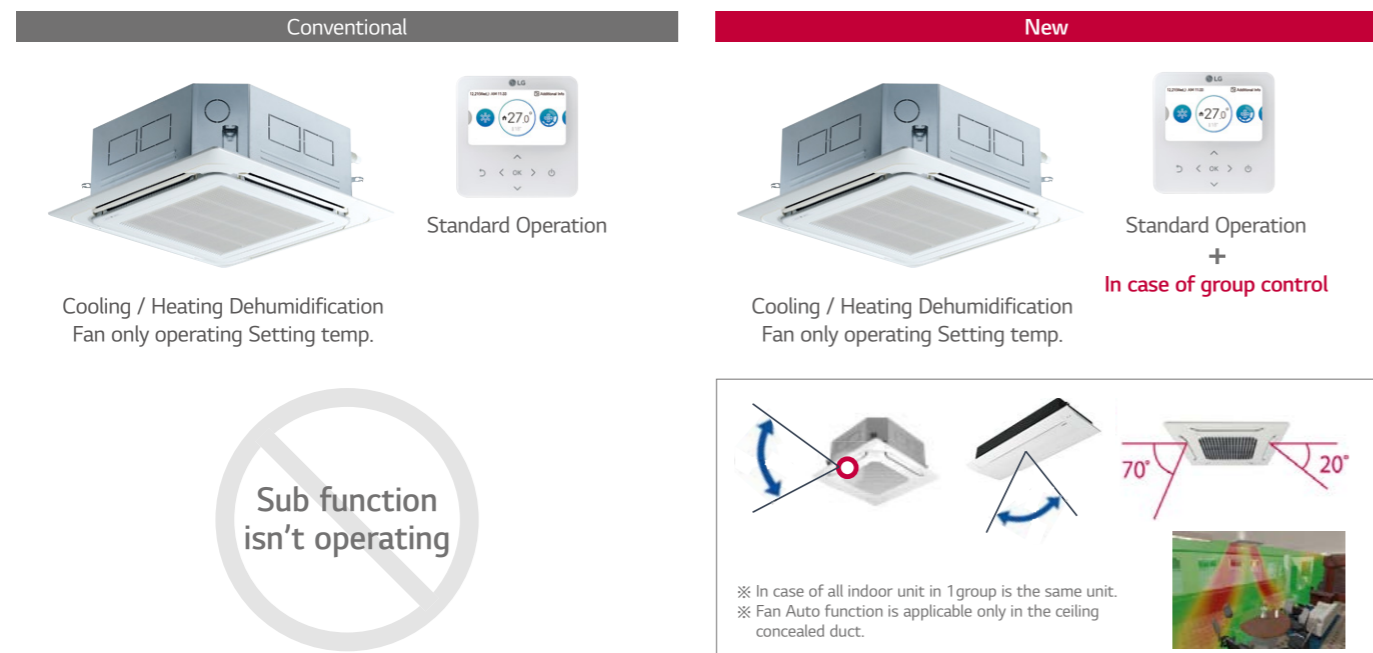

Auto Elevation Grille

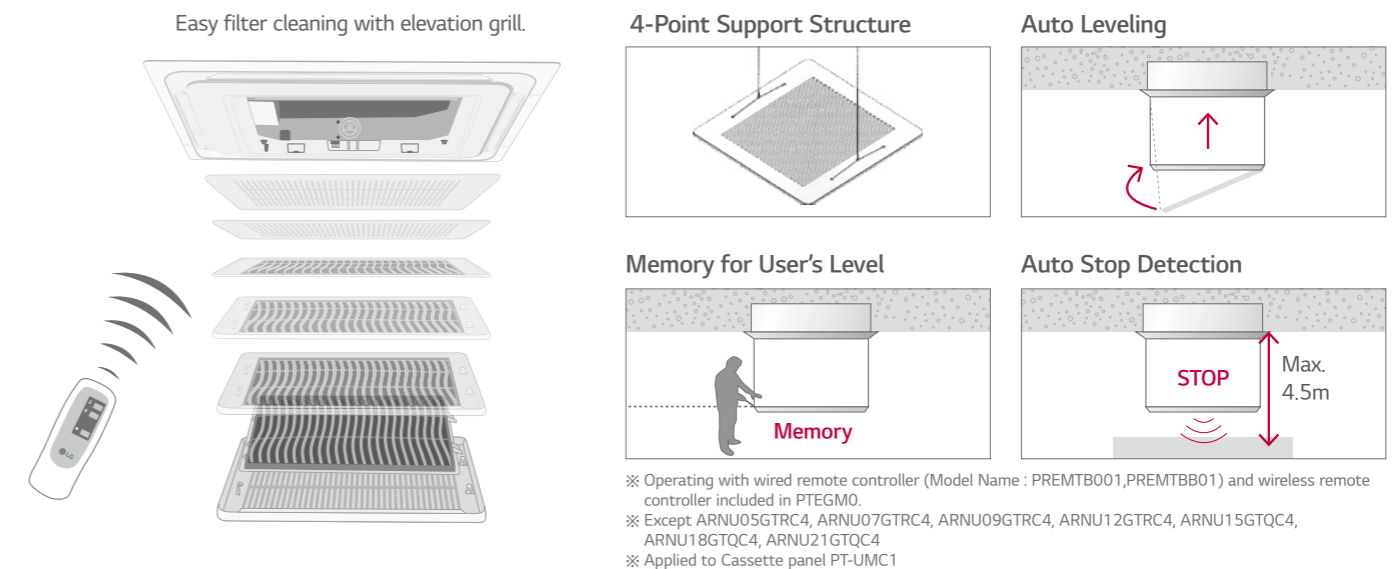

CEILING MOUNTED CASSETTE

High Ceiling Mode

High ceiling mode provides powerful cooling and heating up to 4.2m in height, from ceiling to floor.

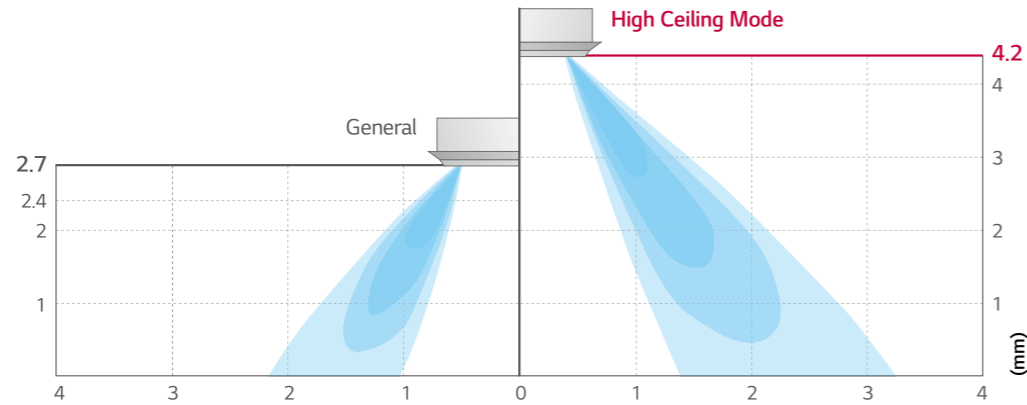

6-Step Vane Control

The Independent Vane Operation feature uses separate motors, making it possible to control all four vanes independently. There are 6 different steps to control air flow direction. Also 1 way cassette has a vane able to execute auto swing between left and right as 120 degree.

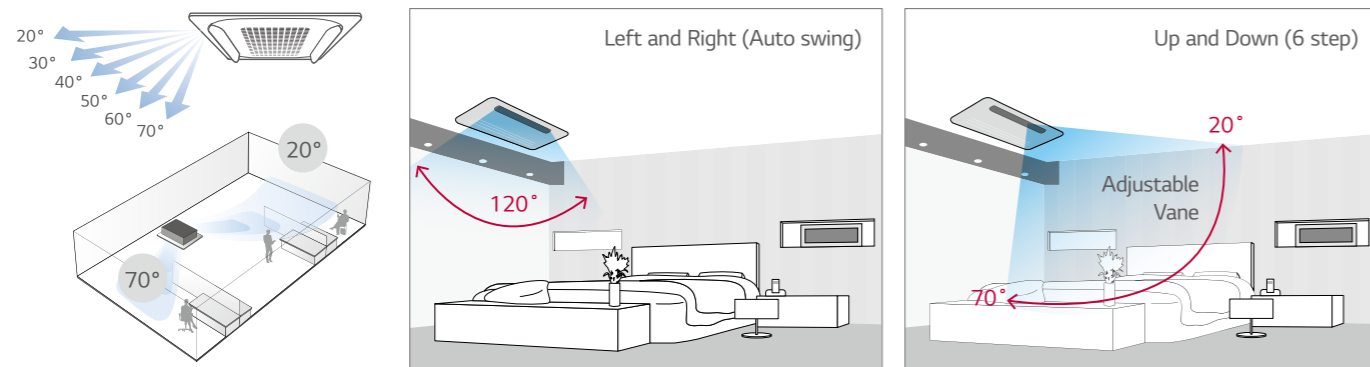

Minimized Height

LG 1 Way cassette isn't affected by installation environment. LG 1 Way cassette height is 132mm and duct is 190mm, so it can provide ideal solution for installation in limited space.

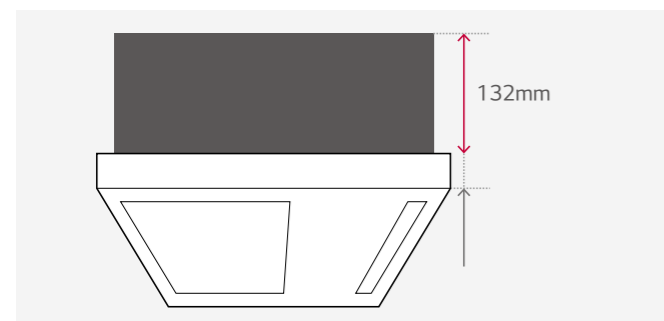

Size Comparison

(Unit : mm)

	A company	B company	LG
1 Way cassette	215	230	132

Flexible Installation

The inspection access hole doesn't require additional ducted space allowing for simple installation scene to be possible.

1 Way cassette

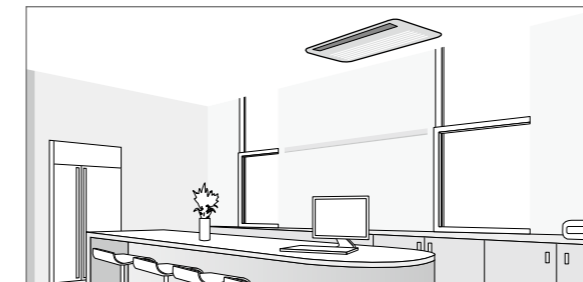

Duct

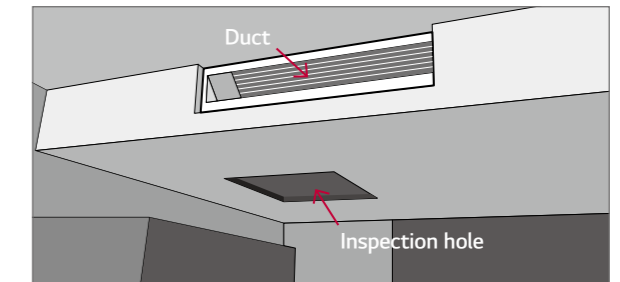

Compact and Stylish Design

New 4 Way cassette panel adapted unibody shape and matching with into the ceiling, panel size is fit into the ceiling tile.

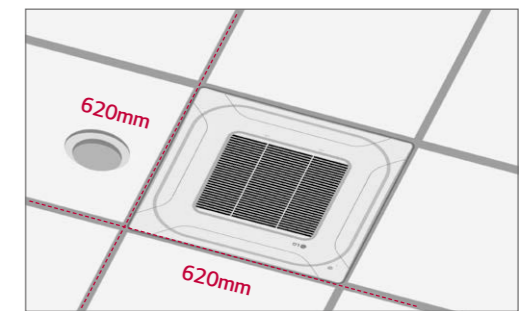
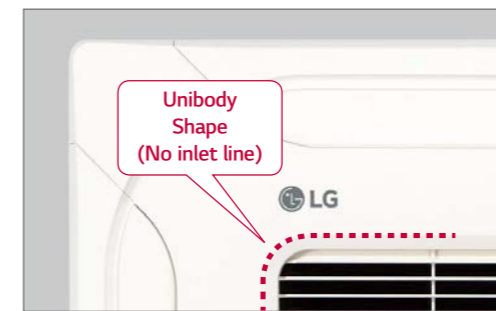

Compact Size

The indoor unit with slim and compact dimensions has reduced the restriction which enables successful installation in various spaces.

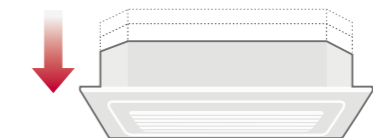

Capacity	Height
7.1 - 9.0kW	204mm
10.6kW	246mm
12.3 - 15.8kW	288mm

※ Length width : 840 x 840mm

Convenient Panel Installation

The detachable corner design makes it easy to adjust the hanger during installation and to check for leakages in the drain connection pipe.

Detachable Corner Design

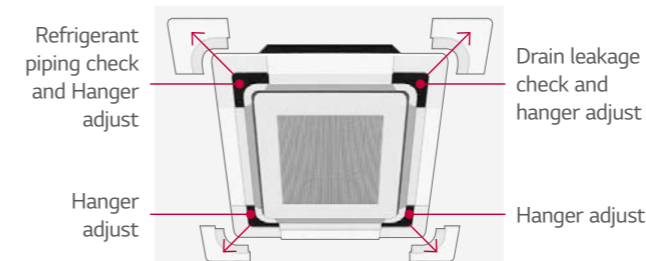

Drain leakage check

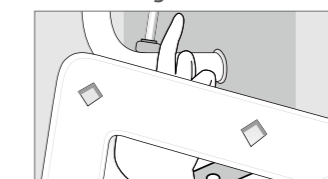

Hanger adjust

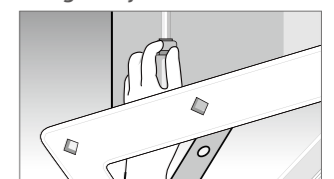

It is easy to install the panel to the body, using the button type panel design.

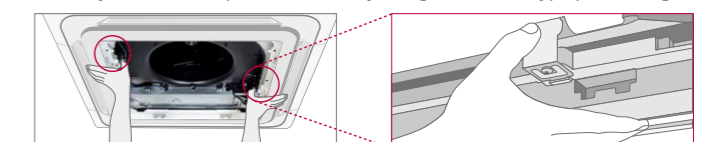

4 Way CASSETTE (570 X 570)

ARNU05GTRB4 / ARNU07GTRB4 / ARNU09GTRB4 / ARNU12GTRB4
ARNU15GTQB4 / ARNU18GTQB4 / ARNU21GTQB4



Model	Unit	ARNU05GTRB4	ARNU07GTRB4	ARNU09GTRB4	ARNU12GTRB4	ARNU15GTQB4	ARNU18GTQB4	ARNU21GTQB4	
Cooling Capacity	kW	1.6	2.2	2.8	3.6	4.5	5.6	6.0	
Heating Capacity	kW	1.8	2.5	3.2	4.0	5.0	6.3	6.8	
Power Input (H / M / L)	Nominal	W	13 / 12 / 11	13 / 12 / 11	14 / 13 / 12	17 / 15 / 13	24 / 21 / 18	25 / 22 / 19	
Dimensions (W x H x D)	Body	mm	570 x 214 x 570	570 x 214 x 570	570 x 214 x 570	570 x 214 x 570	570 x 256 x 570	570 x 256 x 570	
	Shipping	mm	667 x 285 x 646	667 x 285 x 646	667 x 285 x 646	667 x 285 x 646	667 x 327 x 646	667 x 327 x 646	
Fan	Type		Turbo Fan	Turbo Fan	Turbo Fan	Turbo Fan	Turbo Fan	Turbo Fan	
	Motor Output x Number	W	43 x 1	43 x 1	43 x 1	43 x 1	43 x 1	43 x 1	
	Air Flow Rate (H / M / L)	m ³ /min	7.5 / 7.0 / 6.6	7.5 / 7.0 / 6.6	8.0 / 7.5 / 7.1	8.7 / 8.0 / 7.0	11.0 / 10.0 / 9.3	11.2 / 11.0 / 10.0	12.0 / 11.1 / 9.4
	Motor Type		BLDC	BLDC	BLDC	BLDC	BLDC	BLDC	
Air Filter		Pre Filter	Pre Filter	Pre Filter	Pre Filter	Pre Filter	Pre Filter	Pre Filter	
Pipe Connections	Liquid Side	mm (inch)	Ø6.35 (1/4)	Ø6.35 (1/4)	Ø6.35 (1/4)	Ø6.35 (1/4)	Ø6.35 (1/4)	Ø9.52 (3/8)	
	Gas Side	mm (inch)	Ø12.7 (1/2)	Ø12.7 (1/2)	Ø12.7 (1/2)	Ø12.7 (1/2)	Ø12.7 (1/2)	Ø15.88 (5/8)	
	Drain Pipe (Internal Dia.)	mm (inch)	Ø25 (1)	Ø25 (1)	Ø25 (1)	Ø25 (1)	Ø25 (1)	Ø25 (1)	
Weight	Body	kg	12.6	12.6	13.7	13.7	15.0	15.0	
Sound Pressure Levels (H / M / L)	dB(A)	29 / 27 / 26	29 / 27 / 26	30 / 29 / 27	32 / 30 / 27	36 / 34 / 32	37 / 35 / 34	40 / 38 / 34	
Sound Power Levels (H / M / L)	dB(A)	45 / 43 / 42	45 / 43 / 42	46 / 43 / 42	48 / 46 / 43	50 / 48 / 46	51 / 50 / 46	53 / 51 / 46	
Power Supply	Ø, V, Hz	1, 220 - 240, 50 1, 220, 60	1, 220 - 240, 50 1, 220, 60	1, 220 - 240, 50 1, 220, 60	1, 220 - 240, 50 1, 220, 60	1, 220 - 240, 50 1, 220, 60	1, 220 - 240, 50 1, 220, 60	1, 220 - 240, 50 1, 220, 60	
Communication Cable	mm ² x No.	1.0 - 1.5 x 2C	1.0 - 1.5 x 2C	1.0 - 1.5 x 2C	1.0 - 1.5 x 2C	1.0 - 1.5 x 2C	1.0 - 1.5 x 2C	1.0 - 1.5 x 2C	
Decoration Panel (Accessory)	Model Name		PT-UQC PT-QCHW0	PT-UQC PT-QCHW0	PT-UQC PT-QCHW0	PT-UQC PT-QCHW0	PT-UQC PT-QCHW0	PT-UQC PT-QCHW0	
	Exterior Color		Morning Fog	Morning Fog	Morning Fog	Morning Fog	Morning Fog	Morning Fog	
	RAL Code		RAL 9001	RAL 9001	RAL 9001	RAL 9001	RAL 9001	RAL 9001	
	Net Dimensions (W x H x D)	mm	700 x 22 x 700 620 x 20 x 620	700 x 22 x 700 620 x 20 x 620	700 x 22 x 700 620 x 20 x 620	700 x 22 x 700 620 x 20 x 620	700 x 22 x 700 620 x 20 x 620	700 x 22 x 700 620 x 20 x 620	
	Net Weight	kg	3.0 / 3.0	3.0 / 3.0	3.0 / 3.0	3.0 / 3.0	3.0 / 3.0	3.0 / 3.0	

※ Nominal : Performance tested under EN14511
 ※ Rated : Max. power input allowed for fan motor
 Note : 1. Capacities are based on the following conditions
 - Cooling : Indoor temp. 27°C (80.6°F) DB / 19°C (66.2°F) WB, Outdoor temp. 35°C (95°F) DB / 24°C (75.2°F) WB, Interconnecting piping length 7.5m, Level difference of zero
 - Heating : Indoor temp. 20°C (68°F) DB / 15°C (59°F) WB, Outdoor temp. 7°C (44.6°F) DB / 6°C (42.8°F) WB, Interconnecting piping length 7.5m, Level difference of zero
 2. Due to our policy of innovation some specifications may be changed without notification
 3. I.D. : 'Internal Diameter'

Accessories

Chassis	ARNU05GTRB4	ARNU07GTRB4	ARNU09GTRB4	ARNU12GTRB4	ARNU15GTQB4	ARNU18GTQB4	ARNU21GTQB4
Drain Pump				○			
Cassette Cover				PTDCQ			
Refrigerant Leakage Detector				PRLDNVSO			
EEV Kit				PRGK024A0 (-4.5kW)			
Independent Power Module				PRIP0			
Robot Cleaner				-			
Pre Filter (Washable / Anti-fungus)				○			
Ion Generator				-			
CO ₂ Sensor				-			
Ventilation Kit				PTVK430			
IR Receiver				-			
Zone Controller				-			
Dry Contact (with Additional Accessory)				PDRYCB000 (1 point contact) PDRYCB300 (8 points for thermostat compatible) NEW PDRYCB320 (Universal input) ¹⁾ PDRYCB400 (2 points input) PDRYCB500 (Modbus)			
External Input (1 point)				○			
Wi-Fi				PWFMD200			

※ ○ : Applied, - : Not applied
 Option : Refer to model name in table
 1) Available from April 2020

ARNU05GTRC4 / ARNU07GTRC4 / ARNU09GTRC4 / ARNU12GTRC4
ARNU15GTQC4 / ARNU18GTQC4 / ARNU21GTQC4



Model	Unit	ARNU05GTRC4	ARNU07GTRC4	ARNU09GTRC4	ARNU12GTRC4	ARNU15GTQC4	ARNU18GTQC4	ARNU21GTQC4
Cooling Capacity	kW	1.6	2.2	2.8	3.6	4.5	5.6	6.0
Heating Capacity	kW	1.8	2.5	3.2	4.0	5.0	6.3	6.8
Power Input (H / M / L)	Nominal	W	13 / 12 / 11	13 / 12 / 11	14 / 13 / 12	17 / 15 / 13	24 / 21 / 18	25 / 22 / 19
Dimensions (W x H x D)	Body	mm	570 x 214 x 570	570 x 214 x 570	570 x 214 x 570	570 x 214 x 570	570 x 256 x 570	570 x 256 x 570
	Shipping	mm	667 x 285 x 646	667 x 285 x 646	667 x 285 x 646	667 x 285 x 646	667 x 327 x 646	667 x 327 x 646
Fan	Type		Turbo Fan	Turbo Fan	Turbo Fan	Turbo Fan	Turbo Fan	Turbo Fan
	Motor Output x Number	W	43 x 1	43 x 1	43 x 1	43 x 1	43 x 1	43 x 1
	Air Flow Rate (H / M / L)	m ³ /min	7.5 / 7.0 / 6.6	7.5 / 7.0 / 6.6	8.0 / 7.5 / 7.1	8.7 / 8.0 / 7.0	11.0 / 10.0 / 9.3	11.2 / 11.0 / 10.0
	Motor Type		BLDC	BLDC	BLDC	BLDC	BLDC	BLDC
Air Filter		Pre Filter	Pre Filter	Pre Filter	Pre Filter	Pre Filter	Pre Filter	Pre Filter
Pipe Connections	Liquid Side	mm (inch)	Ø6.35 (1/4)	Ø6.35 (1/4)	Ø6.35 (1/4)	Ø6.35 (1/4)	Ø6.35 (1/4)	Ø9.52 (3/8)
	Gas Side	mm (inch)	Ø12.7 (1/2)	Ø12.7 (1/2)	Ø12.7 (1/2)	Ø12.7 (1/2)	Ø12.7 (1/2)	Ø15.88 (5/8)
	Drain Pipe (Internal Dia.)	mm (inch)	Ø25 (1)	Ø25 (1)	Ø25 (1)	Ø25 (1)	Ø25 (1)	Ø25 (1)
Weight	Body	kg	12.6	12.6	13.7	13.7	15.0	15.0
Sound Pressure Levels (H / M / L)	dB(A)	29 / 27 / 26	29 / 27 / 26	30 / 29 / 27	32 / 30 / 27	36 / 34 / 32	37 / 35 / 34	40 / 38 / 34
Sound Power Levels (H / M / L)	dB(A)	45 / 43 / 42	45 / 43 / 42	46 / 43 / 42	48 / 46 / 43	50 / 48 / 46	51 / 50 / 46	53 / 51 / 46
Power Supply	Ø, V, Hz	1, 220 - 240, 50 1, 220, 60	1, 220 - 240, 50 1, 220, 60	1, 220 - 240, 50 1, 220, 60	1, 220 - 240, 50 1, 220, 60	1, 220 - 240, 50 1, 220, 60	1, 220 - 240, 50 1, 220, 60	1, 220 - 240, 50 1, 220, 60
Communication Cable	mm ² x No.	1.0 - 1.5 x 2C	1.0 - 1.5 x 2C	1.0 - 1.5 x 2C	1.0 - 1.5 x 2C	1.0 - 1.5 x 2C	1.0 - 1.5 x 2C	1.0 - 1.5 x 2C
Decoration Panel (Accessory)	Model Name		PT-UQC PT-QCHW0	PT-UQC PT-QCHW0	PT-UQC PT-QCHW0	PT-UQC PT-QCHW0	PT-UQC PT-QCHW0	PT-UQC PT-QCHW0
	Exterior Color		Morning Fog	Morning Fog	Morning Fog	Morning Fog	Morning Fog	Morning Fog
	RAL Code		RAL 9001	RAL 9001	RAL 9001	RAL 9001	RAL 9001	RAL 9001
	Net Dimensions (W x H x D)	mm	700 x 22 x 700 620 x 20 x 620	700 x 22 x 700 620 x 20 x 620	700 x 22 x 700 620 x 20 x 620	700 x 22 x 700 620 x 20 x 620	700 x 22 x 700 620 x 20 x 620	700 x 22 x 700 620 x 20 x 620
	Net Weight	kg	3.0 / 3.0	3.0 / 3.0	3.0 / 3.0	3.0 / 3.0	3.0 / 3.0	3.0 / 3.0

※ Nominal : Performance tested under EN14511
 ※ Rated : Max. power input allowed for fan motor
 Note : 1. Capacities are based on the following conditions
 - Cooling : Indoor temp. 27°C (80.6°F) DB / 19°C (66.2°F) WB, Outdoor temp. 35°C (95°F) DB / 24°C (75.2°F) WB, Interconnecting piping length 7.5m, Level difference of zero
 - Heating : Indoor temp. 20°C (68°F) DB / 15°C (59°F) WB, Outdoor temp. 7°C (44.6°F) DB / 6°C (42.8°F) WB, Interconnecting piping length 7.5m, Level difference of zero
 2. Due to our policy of innovation some specifications may be changed without notification
 3. I.D. : 'Internal Diameter'

Accessories

Chassis	ARNU05GTRC4	ARNU07GTRC4	ARNU09GTRC4	ARNU12GTRC4	ARNU15GTQC4	ARNU18GTQC4	ARNU21GTQC4
Drain Pump				○			
Cassette Cover				PTDCQ			
Refrigerant Leakage Detector				PRLDNVSO			
EEV Kit				PRGK024A0 (-4.5kW)			
Independent Power Module				PRIP0			
Robot Cleaner				-			
Pre Filter (Washable / Anti-fungus)				○			
Ion Generator				-			
CO ₂ Sensor				-			
Ventilation Kit				PTVK430			
IR Receiver				-			
Zone Controller				-			
Dry Contact (with Additional Accessory)				PDRYCB000 (1 point contact) PDRYCB300 (8 points for thermostat compatible) NEW PDRYCB320 (Universal input) ¹⁾ PDRYCB400 (2 points input) PDRYCB500 (Modbus)			
External Input (1 point)				○			
Wi-Fi				-			

※ ○ : Applied, - : Not applied
 Option : Refer to model name in table
 1) Available from April 2020

4 Way CASSETTE (840 X 840)

ARNU24GTPC4 / ARNU28GTPC4 / ARNU30GTPC4 / ARNU36GTNC4



Model	Unit	ARNU24GTPC4	ARNU28GTPC4	ARNU30GTPC4	ARNU36GTNC4	
Cooling Capacity	kW	7.1	8.2	9.0	10.6	
Heating Capacity	kW	8.0	9.2	10.0	11.9	
Power Input (H / M / L)	Nominal	W	31 / 26 / 23	40 / 31 / 25	40 / 34 / 27	70 / 53 / 43
	Body	mm	840 x 204 x 840	840 x 204 x 840	840 x 204 x 840	840 x 246 x 840
Dimensions (W x H x D)	Shipping	mm	922 x 276 x 917	922 x 276 x 917	922 x 276 x 917	922 x 318 x 917
	Type		Turbo Fan	Turbo Fan	Turbo Fan	Turbo Fan
Fan	Motor Output x Number	W	30 x 1	30 x 1	30 x 1	135 x 1
	Air Flow Rate (H / M / L)	m ³ /min	17.0 / 15.0 / 13.0	19.0 / 16.0 / 14.0	24.3 / 22.8 / 19.5	25.0 / 21.0 / 19.0
	Motor Type		BLDC	BLDC	BLDC	BLDC
Air Filter		Pre Filter	Pre Filter	Pre Filter	Pre Filter	
Pipe Connections	Liquid Side	mm (inch)	Ø9.52 (3/8)	Ø9.52 (3/8)	Ø9.52 (3/8)	Ø9.52 (3/8)
	Gas Side	mm (inch)	Ø15.88 (5/8)	Ø15.88 (5/8)	Ø15.88 (5/8)	Ø15.88 (5/8)
	Drain Pipe (Internal Dia.)	mm (inch)	Ø25 (1)	Ø25 (1)	Ø25 (1)	Ø25 (1)
Weight	Body	kg	20.8	20.8	20.8	23.5
Sound Pressure Levels (H / M / L)	dB(A)	36 / 34 / 31	39 / 35 / 33	40 / 36 / 33	43 / 40 / 37	
Sound Power Levels (H / M / L)	dB(A)	46 / 44 / 43	52 / 46 / 44	58 / 57 / 54	56 / 53 / 51	
Power Supply	Ø, V, Hz		1, 220 - 240, 50	1, 220 - 240, 50	1, 220 - 240, 50	1, 220 - 240, 50
			1, 220, 60	1, 220, 60	1, 220, 60	1, 220, 60
Communication Cable	mm ² x No.	1.0 - 1.5 x 2C	1.0 - 1.5 x 2C	1.0 - 1.5 x 2C	1.0 - 1.5 x 2C	
Decoration Panel (Accessory)	Model Name		PT-UMC1 PT-MCHW0	PT-UMC1 PT-MCHW0	PT-UMC1 PT-MCHW0	PT-UMC1 PT-MCHW0
	Exterior Color		Morning Fog	Morning Fog	Morning Fog	Morning Fog
	RAL Code		RAL 9001	RAL 9001	RAL 9001	RAL 9001
	Net Dimensions (W x H x D)	mm	950 x 25 x 950 950 x 35 x 950	950 x 25 x 950 950 x 35 x 950	950 x 25 x 950 950 x 35 x 950	950 x 25 x 950 950 x 35 x 950
	Net Weight	kg	5.0 / 6.3	5.0 / 6.3	5.0 / 6.3	5.0 / 6.3

※ Nominal : Performance tested under EN14511
 ※ Rated : Max. power input allowed for fan motor
 Note : 1. Capacities are based on the following conditions
 - Cooling : Indoor temp. 27°C (80.6°F) DB / 19°C (66.2°F) WB, Outdoor temp. 35°C (95°F) DB / 24°C (75.2°F) WB, Interconnecting piping length 7.5m, Level difference of zero
 - Heating : Indoor temp. 20°C (68°F) DB / 15°C (59°F) WB, Outdoor temp. 7°C (44.6°F) DB / 6°C (42.8°F) WB, Interconnecting piping length 7.5m, Level difference of zero
 2. Due to our policy of innovation some specifications may be changed without notification
 3. I.D : 'Internal Diameter'

Accessories

Chassis	ARNU24GTPC4	ARNU28GTPC4	ARNU30GTPC4	ARNU36GTNC4
Drain Pump			○	
Cassette Cover			PTDCM	
Refrigerant Leakage Detector			PRLDNVSO	
EEV Kit			-	
Independent Power Module			PRIPO	
Robot Cleaner			-	
Pre Filter (Washable / Anti-fungus)			○	
Ion Generator			-	
CO ₂ Sensor			-	
Ventilation Kit			PTVK430	
IR Receiver			-	
Zone Controller			-	
Dry Contact (with Additional Accessory)			PDRYCB000 (1 point contact) PDRYCB300 (8 points for thermostat compatible) NEW PDRYCB320 (Universal input) ¹⁾ PDRYCB400 (2 points input) PDRYCB500 (Modbus)	
External Input (1 point)			○	
Wi-Fi			PWFMD200	

※ ○ : Applied, - : Not applied
 Option : Refer to model name in table
 1) Available from April 2020

ARNU42GTMC4 / ARNU48GTMC4 / ARNU54GTMC4



Model	Unit	ARNU42GTMC4	ARNU48GTMC4	ARNU54GTMC4	
Cooling Capacity	kW	12.3	14.1	15.8	
Heating Capacity	kW	13.8	15.9	18.0	
Power Input (H / M / L)	Nominal	W	104 / 75 / 53	120 / 80 / 62	135 / 93 / 70
	Body	mm	840 x 288 x 840	840 x 288 x 840	840 x 288 x 840
Dimensions (W x H x D)	Shipping	mm	922 x 360 x 917	922 x 360 x 917	922 x 360 x 917
	Type		Turbo Fan	Turbo Fan	Turbo Fan
Fan	Motor Output x Number	W	135 x 1	135 x 1	135 x 1
	Air Flow Rate (H / M / L)	m ³ /min	30.0 / 27.0 / 24.0	31.0 / 29.0 / 27.0	34.0 / 32.0 / 27.0
	Motor Type		BLDC	BLDC	BLDC
Air Filter		Pre Filter	Pre Filter	Pre Filter	
Pipe Connections	Liquid Side	mm (inch)	Ø9.52 (3/8)	Ø9.52 (3/8)	Ø9.52 (3/8)
	Gas Side	mm (inch)	Ø15.88 (5/8)	Ø15.88 (5/8)	Ø15.88 (5/8)
	Drain Pipe (Internal Dia.)	mm (inch)	Ø25 (1)	Ø25 (1)	Ø25 (1)
Weight	Body	kg	25.6	25.6	26.5
Sound Pressure Levels (H / M / L)	dB(A)	44 / 41 / 38	46 / 43 / 41	50 / 48 / 44	
Sound Power Levels (H / M / L)	dB(A)	58 / 55 / 50	60 / 56 / 55	60 / 58 / 55	
Power Supply	Ø, V, Hz		1, 220 - 240, 50	1, 220 - 240, 50	1, 220 - 240, 50
			1, 220, 60	1, 220, 60	1, 220, 60
Communication Cable	mm ² x No.	1.0 - 1.5 x 2C	1.0 - 1.5 x 2C	1.0 - 1.5 x 2C	
Decoration Panel (Accessory)	Model Name		PT-UMC1 PT-MCHW0	PT-UMC1 PT-MCHW0	PT-UMC1 PT-MCHW0
	Exterior Color		Morning Fog	Morning Fog	Morning Fog
	RAL Code		RAL 9001	RAL 9001	RAL 9001
	Net Dimensions (W x H x D)	mm	950 x 25 x 950 950 x 35 x 950	950 x 25 x 950 950 x 35 x 950	950 x 25 x 950 950 x 35 x 950
	Net Weight	kg	5.0 / 6.3	5.0 / 6.3	5.0 / 6.3

※ Nominal : Performance tested under EN14511
 ※ Rated : Max. power input allowed for fan motor
 Note : 1. Capacities are based on the following conditions
 - Cooling : Indoor temp. 27°C (80.6°F) DB / 19°C (66.2°F) WB, Outdoor temp. 35°C (95°F) DB / 24°C (75.2°F) WB, Interconnecting piping length 7.5m, Level difference of zero
 - Heating : Indoor temp. 20°C (68°F) DB / 15°C (59°F) WB, Outdoor temp. 7°C (44.6°F) DB / 6°C (42.8°F) WB, Interconnecting piping length 7.5m, Level difference of zero
 2. Due to our policy of innovation some specifications may be changed without notification
 3. I.D : 'Internal Diameter'

Accessories

Chassis	ARNU42GTMC4	ARNU48GTMC4	ARNU54GTMC4
Drain Pump			○
Cassette Cover			PTDCM
Refrigerant Leakage Detector			PRLDNVSO
EEV Kit			-
Independent Power Module			PRIPO
Robot Cleaner			-
Pre Filter (Washable / Anti-fungus)			○
Ion Generator			-
CO ₂ Sensor			-
Ventilation Kit			PTVK430
IR Receiver			-
Zone Controller			-
Dry Contact (with Additional Accessory)			PDRYCB000 (1 point contact) PDRYCB300 (8 points for thermostat compatible) NEW PDRYCB320 (Universal input) ¹⁾ PDRYCB400 (2 points input) PDRYCB500 (Modbus)
External Input (1 point)			○
Wi-Fi			PWFMD200

※ ○ : Applied, - : Not applied
 Option : Refer to model name in table
 1) Available from April 2020

4 Way CASSETTE HIGH SENSIBLE (840 X 840)

ARNU07GTNA4 / ARNU09GTNA4 / ARNU12GTNA4
ARNU15GTNA4 / ARNU18GTNA4



Model	Unit	ARNU07GTNA4	ARNU09GTNA4	ARNU12GTNA4	ARNU15GTNA4	ARNU18GTNA4	
Cooling Capacity	kW	2.2	2.8	3.6	4.5	5.6	
Heating Capacity	kW	2.5	3.2	4	5	6.3	
Power Input (H / M / L)	Nominal	W	18 / 15 / 12	19 / 15 / 12	22 / 17 / 14	25 / 17 / 14	
Dimensions (W x H x D)	Body	mm	840 x 246 x 840	840 x 246 x 840	840 x 246 x 840	840 x 246 x 840	
	Shipping	mm	922 x 318 x 917	922 x 318 x 917	922 x 318 x 917	922 x 318 x 917	
Fan	Type		Turbo Fan	Turbo Fan	Turbo Fan	Turbo Fan	
	Motor Output x Number	W	135 x 1	135 x 1	135 x 1	135 x 1	
	Air Flow Rate (H / M / L)	m ³ /min	13.0 / 12.0 / 11.0	13.5 / 12.0 / 11.0	14.0 / 13.0 / 12.0	15.0 / 13.0 / 12.0	16.0 / 14.0 / 12.0
	Motor Type		BLDC	BLDC	BLDC	BLDC	
Air Filter			Pre Filter	Pre Filter	Pre Filter	Pre Filter	
Pipe Connections	Liquid Side	mm (inch)	Ø9.52 (3/8)	Ø9.52 (3/8)	Ø9.52 (3/8)	Ø9.52 (3/8)	
	Gas Side	mm (inch)	Ø15.88 (5/8)	Ø15.88 (5/8)	Ø15.88 (5/8)	Ø15.88 (5/8)	
	Drain Pipe (Internal Dia.)	mm (inch)	Ø25 (1)	Ø25 (1)	Ø25 (1)	Ø25 (1)	
Weight	Body	kg	23.5	23.5	23.5	23.5	
Sound Pressure Levels (H / M / L)		dB(A)	35 / 33 / 30	35 / 33 / 30	37 / 35 / 33	39 / 35 / 33	40 / 35 / 33
Sound Power Levels (H / M / L)		dB(A)	42 / 38 / 36	42 / 38 / 36	43 / 40 / 38	44 / 40 / 38	45 / 41 / 38
Power Supply	Ø, V, Hz		1, 220 - 240, 50	1, 220 - 240, 50	1, 220 - 240, 50	1, 220 - 240, 50	
			1, 220, 60	1, 220, 60	1, 220, 60	1, 220, 60	
Communication Cable		mm ² x No.	1.0 - 1.5 x 2C	1.0 - 1.5 x 2C	1.0 - 1.5 x 2C	1.0 - 1.5 x 2C	
Decoration Panel (Accessory)	Model Name		PT-UMC1 PT-MCHWO	PT-UMC1 PT-MCHWO	PT-UMC1 PT-MCHWO	PT-UMC1 PT-MCHWO	
	Exterior Color		Morning Fog	Morning Fog	Morning Fog	Morning Fog	
	RAL Code		RAL 9001	RAL 9001	RAL 9001	RAL 9001	
	Net Dimensions (W x H x D)	mm	950 x 25 x 950 950 x 35 x 950	950 x 25 x 950 950 x 35 x 950	950 x 25 x 950 950 x 35 x 950	950 x 25 x 950 950 x 35 x 950	950 x 25 x 950 950 x 35 x 950
	Net Weight	kg	5.0 / 6.3	5.0 / 6.3	5.0 / 6.3	5.0 / 6.3	

※ Nominal : Performance tested under EN14511
 ※ Rated : Max. power input allowed for fan motor
 Note : 1. Capacities are based on the following conditions
 - Cooling : Indoor temp. 27°C (80.6°F) DB / 19°C (66.2°F) WB, Outdoor temp. 35°C (95°F) DB / 24°C (75.2°F) WB, Interconnecting piping length 7.5m, Level difference of zero
 - Heating : Indoor temp. 20°C (68°F) DB / 15°C (59°F) WB, Outdoor temp. 7°C (44.6°F) DB / 6°C (42.8°F) WB, Interconnecting piping length 7.5m, Level difference of zero
 2. Due to our policy of innovation some specifications may be changed without notification
 3. I.D : 'Internal Diameter'

Accessories

Chassis	ARNU07GTNA4	ARNU09GTNA4	ARNU12GTNA4	ARNU15GTNA4	ARNU18GTNA4
Drain Pump			○		
Cassette Cover			PTDCM		
Refrigerant Leakage Detector			PRLDNVSO		
EEV Kit			-		
Independent Power Module			PRIPO		
Robot Cleaner			-		
Pre Filter (Washable / Anti-fungus)			○		
Ion Generator			-		
CO ₂ Sensor			-		
Ventilation Kit			PTVK430		
IR Receiver			-		
Zone Controller			-		
Dry Contact (with Additional Accessory)			PDRYCB000 (1 point contact) PDRYCB300 (8 points for thermostat compatible) NEW PDRYCB320 (Universal input) ¹⁾ PDRYCB400 (2 points input) PDRYCB500 (Modbus)		
External Input (1 point)			○		
Wi-Fi			PWFMD200		

※ ○ : Applied, - : Not applied
 Option : Refer to model name in table
 1) Available from April 2020

ARNU24GTMA4 / ARNU28GTMA4
ARNU36GTMA4 / ARNU42GTMA4



Model	Unit	ARNU24GTMA4	ARNU28GTMA4	ARNU36GTMA4	ARNU42GTMA4	
Cooling Capacity	kW	7.1	8.2	10.6	12.3	
Heating Capacity	kW	8	9.2	11.9	13.8	
Power Input (H / M / L)	Nominal	W	47 / 39 / 31	52 / 43 / 31	64 / 47 / 34	104 / 75 / 53
Dimensions (W x H x D)	Body	mm	840 x 288 x 840	840 x 288 x 840	840 x 288 x 840	840 x 288 x 840
	Shipping	mm	922 x 360 x 917	922 x 360 x 917	922 x 360 x 917	922 x 360 x 917
Fan	Type		Turbo Fan	Turbo Fan	Turbo Fan	Turbo Fan
	Motor Output x Number	W	135 x 1	135 x 1	135 x 1	135 x 1
	Air Flow Rate (H / M / L)	m ³ /min	22.0 / 20.0 / 18.0	23.0 / 21.0 / 18.0	26.0 / 23.0 / 20.0	30.0 / 26.0 / 23.0
	Motor Type		BLDC	BLDC	BLDC	BLDC
Air Filter			Pre Filter	Pre Filter	Pre Filter	Pre Filter
Pipe Connections	Liquid Side	mm (inch)	Ø9.52 (3/8)	Ø9.52 (3/8)	Ø9.52 (3/8)	Ø9.52 (3/8)
	Gas Side	mm (inch)	Ø15.88 (5/8)	Ø15.88 (5/8)	Ø15.88 (5/8)	Ø15.88 (5/8)
	Drain Pipe (Internal Dia.)	mm (inch)	Ø25 (1)	Ø25 (1)	Ø25 (1)	Ø25 (1)
Weight	Body	kg	25.6	25.6	25.6	25.6
Sound Pressure Levels (H / M / L)		dB(A)	42 / 40 / 38	43 / 41 / 38	46 / 42 / 39	49 / 45 / 42
Sound Power Levels (H / M / L)		dB(A)	48 / 45 / 43	49 / 47 / 43	52 / 48 / 44	55 / 51 / 48
Power Supply	Ø, V, Hz		1, 220 - 240, 50	1, 220 - 240, 50	1, 220 - 240, 50	1, 220 - 240, 50
			1, 220, 60	1, 220, 60	1, 220, 60	1, 220, 60
Communication Cable		mm ² x No.	1.0 - 1.5 x 2C	1.0 - 1.5 x 2C	1.0 - 1.5 x 2C	1.0 - 1.5 x 2C
Decoration Panel (Accessory)	Model Name		PT-UMC1 PT-MCHWO	PT-UMC1 PT-MCHWO	PT-UMC1 PT-MCHWO	PT-UMC1 PT-MCHWO
	Exterior Color		Morning Fog	Morning Fog	Morning Fog	Morning Fog
	RAL Code		RAL 9001	RAL 9001	RAL 9001	RAL 9001
	Net Dimensions (W x H x D)	mm	950 x 25 x 950 950 x 35 x 950	950 x 25 x 950 950 x 35 x 950	950 x 25 x 950 950 x 35 x 950	950 x 25 x 950 950 x 35 x 950
	Net Weight	kg	5.0 / 6.3	5.0 / 6.3	5.0 / 6.3	5.0 / 6.3

※ Nominal : Performance tested under EN14511
 ※ Rated : Max. power input allowed for fan motor
 Note : 1. Capacities are based on the following conditions
 - Cooling : Indoor temp. 27°C (80.6°F) DB / 19°C (66.2°F) WB, Outdoor temp. 35°C (95°F) DB / 24°C (75.2°F) WB, Interconnecting piping length 7.5m, Level difference of zero
 - Heating : Indoor temp. 20°C (68°F) DB / 15°C (59°F) WB, Outdoor temp. 7°C (44.6°F) DB / 6°C (42.8°F) WB, Interconnecting piping length 7.5m, Level difference of zero
 2. Due to our policy of innovation some specifications may be changed without notification
 3. I.D : 'Internal Diameter'

Accessories

Chassis	ARNU24GTMA4	ARNU28GTMA4	ARNU36GTMA4	ARNU42GTMA4
Drain Pump			○	
Cassette Cover			PTDCM	
Refrigerant Leakage Detector			PRLDNVSO	
EEV Kit			-	
Independent Power Module			PRIPO	
Robot Cleaner			-	
Pre Filter (Washable / Anti-fungus)			○	
Ion Generator			-	
CO ₂ Sensor			-	
Ventilation Kit			PTVK430	
IR Receiver			-	
Zone Controller			-	
Dry Contact (with Additional Accessory)			PDRYCB000 (1 point contact) PDRYCB300 (8 points for thermostat compatible) NEW PDRYCB320 (Universal input) ¹⁾ PDRYCB400 (2 points input) PDRYCB500 (Modbus)	
External Input (1 point)			○	
Wi-Fi			PWFMD200	

※ ○ : Applied, - : Not applied
 Option : Refer to model name in table
 1) Available from April 2020

2 Way CASSETTE

ARNU09GTSC4 / ARNU12GTSC4
ARNU18GTSC4 / ARNU24GTSC4



Model	Unit	ARNU09GTSC4	ARNU12GTSC4	ARNU18GTSC4	ARNU24GTSC4
Cooling Capacity	kW	2.8	3.6	5.6	7.1
Heating Capacity	kW	3.2	4	6.3	8
Power Input (H / M / L)	Nominal	W	16 / 14 / 11	18 / 14 / 11	19 / 16 / 14
Dimensions (W x H x D)	Body	mm	830 x 225 x 600	830 x 225 x 600	830 x 225 x 600
	Shipping	mm	1,033 x 270 x 665	1,033 x 270 x 665	1,033 x 270 x 665
Fan	Type		Turbo Fan	Turbo Fan	Turbo Fan
	Motor Output x Number	W x No.	37 x 1	37 x 1	37 x 1
	Air Flow Rate (H / M / L)	m ³ /min	10.8 / 9.8 / 9.1	11.1 / 10.3 / 9.1	11.8 / 10.8 / 9.8
	Motor Type		BLDC	BLDC	BLDC
Air Filter		Pre Filter	Pre Filter	Pre Filter	Pre Filter
Pipe Connections	Liquid Side	mm (inch)	Ø6.35 (1/4)	Ø6.35 (1/4)	Ø6.35 (1/4)
	Gas Side	mm (inch)	Ø12.7 (1/2)	Ø12.7 (1/2)	Ø12.7 (1/2)
	Drain Pipe (Internal Dia.)	mm (inch)	Ø25 (1)	Ø25 (1)	Ø25 (1)
Weight	Body	kg	18.1	18.1	18.1
Sound Pressure Levels (H / M / L)		dB(A)	33 / 31 / 29	34 / 32 / 29	35 / 33 / 31
Sound Power Levels (H / M / L)		dB(A)	42 / 40 / 38	43 / 41 / 39	44 / 42 / 40
Power Supply		Ø, V, Hz	1, 220 - 240, 50	1, 220 - 240, 50	1, 220 - 240, 50
			1, 220, 60	1, 220, 60	1, 220, 60
Communication Cable		mm ² x No.	1.0 - 1.5 x 2C	1.0 - 1.5 x 2C	1.0 - 1.5 x 2C
Decoration Panel (Accessory)	Model Name		PT-USC	PT-USC	PT-USC
	Exterior Color		Morning Fog	Morning Fog	Morning Fog
	RAL Code		RAL 9001	RAL 9001	RAL 9001
	Net Dimensions (W x H x D)	mm	1,100 x 28 x 690	1,100 x 28 x 690	1,100 x 28 x 690
	Net Weight	kg	4.7	4.7	4.7

※ Nominal : Performance tested under EN14511
 ※ Rated : Max. power input allowed for fan motor
 Note : 1. Capacities are based on the following conditions
 - Cooling : Indoor temp. 27°C (80.6°F) DB / 19°C (66.2°F) WB, Outdoor temp. 35°C (95°F) DB / 24°C (75.2°F) WB, Interconnecting piping length 7.5m, Level difference of zero
 - Heating : Indoor temp. 20°C (68°F) DB / 15°C (59°F) WB, Outdoor temp. 7°C (44.6°F) DB / 6°C (42.8°F) WB, Interconnecting piping length 7.5m, Level difference of zero
 2. Due to our policy of innovation some specifications may be changed without notification
 3. ID : 'Internal Diameter'

Accessories

Chassis	ARNU09GTSC4	ARNU12GTSC4	ARNU18GTSC4	ARNU24GTSC4
Drain Pump			○	
Cassette Cover			-	
Refrigerant Leakage Detector		PRLDNV50		
EEV Kit		PRGK024A0 (-5.6kW)		
Independent Power Module		PRIP0		
Robot Cleaner		-		
Pre Filter (Washable / Anti-fungus)		○		
Ion Generator		-		
CO ₂ Sensor		-		
Ventilation Kit		-		
IR Receiver		-		
Zone Controller		-		
Dry Contact (with Additional Accessory)		PDRYCB000 (1 point contact) PDRYCB300 (8 points for thermostat compatible) NEW PDRYCB320 (Universal input) ¹⁾ PDRYCB400 (2 points input) PDRYCB500 (Modbus)		
External Input (1 point)		○		
Wi-Fi		PWFMD200		

※ ○ : Applied, - : Not applied
 Option : Refer to model name in table
 1) Available from April 2020

1 Way CASSETTE

ARNU07GTUC4 / ARNU09GTUC4 / ARNU12GTUC4
ARNU18GTTC4 / ARNU24GTTC4



Model	Unit	ARNU07GTUC4	ARNU09GTUC4	ARNU12GTUC4	ARNU18GTTC4	ARNU24GTTC4
Cooling Capacity	kW	2.2	2.8	3.6	5.6	7.1
Heating Capacity	kW	2.5	3.2	4.0	6.3	7.1
Power Input (H / M / L)	Nominal	W	20 / 18 / 16	22 / 20 / 18	24 / 22 / 20	38 / 28 / 24
Dimensions (W x H x D)	Body	mm	860 x 132 x 450	860 x 132 x 450	860 x 132 x 450	1,180 x 132 x 450
	Shipping	mm	1,129 x 259 x 538	1,129 x 259 x 538	1,129 x 259 x 538	1,499 x 259 x 538
Fan	Type		Cross Flow Fan	Cross Flow Fan	Cross Flow Fan	Cross Flow Fan
	Motor Output x Number	W x No.	30 x 1	30 x 1	30 x 1	30 x 1
	Air Flow Rate (H / M / L)	m ³ /min	8.2 / 7.3 / 6.4	9.2 / 8.6 / 8.2	10.0 / 9.2 / 8.2	13.3 / 12.1 / 10.9
	Motor Type		BLDC	BLDC	BLDC	BLDC
Air Filter		Pre Filter	Pre Filter	Pre Filter	Pre Filter	Pre Filter
Pipe Connections	Liquid Side	mm (inch)	Ø6.35 (1/4)	Ø6.35 (1/4)	Ø6.35 (1/4)	Ø6.35 (1/4)
	Gas Side	mm (inch)	Ø12.7 (1/2)	Ø12.7 (1/2)	Ø12.7 (1/2)	Ø12.7 (1/2)
	Drain Pipe (Internal Dia.)	mm (inch)	Ø25 (1)	Ø25 (1)	Ø25 (1)	Ø25 (1)
Weight	Body	kg	13.6	13.6	13.6	15.6
Sound Pressure Levels (H / M / L)		dB(A)	32 / 29 / 25	35 / 34 / 32	38 / 35 / 32	40 / 37 / 35
Sound Power Levels (H / M / L)		dB(A)	47 / 44 / 41	50 / 48 / 47	52 / 50 / 47	56 / 51 / 48
Power Supply		Ø, V, Hz	1, 220 - 240, 50	1, 220 - 240, 50	1, 220 - 240, 50	1, 220 - 240, 50
			1, 220, 60	1, 220, 60	1, 220, 60	1, 220, 60
Communication Cable		mm ² x No.	1.0 - 1.5 x 2C	1.0 - 1.5 x 2C	1.0 - 1.5 x 2C	1.0 - 1.5 x 2C
Decoration Panel (Accessory)	Model Name		PT-UUC (Grill) PT-UUD (Panel)	PT-UUC (Grill) PT-UUD (Panel)	PT-UUC (Grill) PT-UTD (Panel)	PT-UTC (Grill) PT-UTD (Panel)
	Exterior Color		Noble White	Noble White	Noble White	Noble White
	RAL Code		RAL 9003	RAL 9003	RAL 9003	RAL 9003
	Net Dimensions (W x H x D)	mm	1,100 x 34 x 500 1,100 x 34 x 500	1,100 x 34 x 500 1,100 x 34 x 500	1,100 x 34 x 500 1,100 x 34 x 500	1,420 x 34 x 500 1,420 x 34 x 500
	Net Weight	kg	4.6 / 5.3	4.6 / 5.3	4.6 / 5.3	5.5 / 6.5

※ Nominal : Performance tested under EN14511
 ※ Rated : Max. power input allowed for fan motor
 Note : 1. Capacities are based on the following conditions
 - Cooling : Indoor temp. 27°C (80.6°F) DB / 19°C (66.2°F) WB, Outdoor temp. 35°C (95°F) DB / 24°C (75.2°F) WB, Interconnecting piping length 7.5m, Level difference of zero
 - Heating : Indoor temp. 20°C (68°F) DB / 15°C (59°F) WB, Outdoor temp. 7°C (44.6°F) DB / 6°C (42.8°F) WB, Interconnecting piping length 7.5m, Level difference of zero
 2. Due to our policy of innovation some specifications may be changed without notification
 3. ID : 'Internal Diameter'

Accessories

Chassis	ARNU07GTUC4	ARNU09GTUC4	ARNU12GTUC4	ARNU18GTTC4	ARNU24GTTC4
Drain Pump		○			○
Cassette Cover		-			-
Refrigerant Leakage Detector		PRLDNV50			PRLDNV50
EEV Kit		PRGK024A0			-
Independent Power Module		PRIP0			PRIP0
Robot Cleaner		-			-
Pre Filter (Washable / Anti-fungus)		○			○
Ion Generator		-			-
CO ₂ Sensor		-			-
Ventilation Kit		-			-
IR Receiver		-			-
Zone Controller		-			-
Dry Contact (with Additional Accessory)		PDRYCB000 (1 point contact) PDRYCB300 (8 points for thermostat compatible) NEW PDRYCB320 (Universal input) ¹⁾ PDRYCB400 (2 points input) PDRYCB500 (Modbus)			PDRYCB000 (1 point contact) PDRYCB300 (8 points for thermostat compatible) PDRYCB400 (2 points input) PDRYCB500 (Modbus)
External Input (1 point)		○			○
Wi-Fi		-			-

※ ○ : Applied, - : Not applied
 Option : Refer to model name in table
 1) Available from April 2020

1 Way CASSETTE

ARNU07GTUD4 / ARNU09GTUD4 / ARNU12GTUD4



Model	Unit	ARNU07GTUD4	ARNU09GTUD4	ARNU12GTUD4
Cooling Capacity	kW	2.2	2.8	3.6
Heating Capacity	kW	2.5	3.2	4.0
Power Input (H / M / L)	Nominal	W	20 / 18 / 16	22 / 20 / 18
				24 / 22 / 20
Dimensions (W x H x D)	Body	mm	860 x 132 x 450	860 x 132 x 450
	Shipping	mm	1,129 x 259 x 538	1,129 x 259 x 538
Fan	Type		Cross Flow Fan	Cross Flow Fan
	Motor Output x Number	W x No.	30 x 1	30 x 1
	Air Flow Rate (H / M / L)	m ³ /min	8.2 / 7.3 / 6.4	9.2 / 8.6 / 8.2
	Motor Type		BLDC	BLDC
Air Filter			Pre Filter	Pre Filter
Pipe Connections	Liquid Side	mm (inch)	Ø6.35 (1/4)	Ø6.35 (1/4)
	Gas Side	mm (inch)	Ø12.7 (1/2)	Ø12.7 (1/2)
	Drain Pipe (Internal Dia.)	mm (inch)	Ø25 (1)	Ø25 (1)
Weight	Body	kg	13.6	13.6
Sound Pressure Levels (H / M / L)		dB(A)	32 / 29 / 25	35 / 34 / 32
Sound Power Levels (H / M / L)		dB(A)	47 / 44 / 41	50 / 48 / 47
Power Supply		∅, V, Hz	1, 220 - 240, 50	1, 220 - 240, 50
			1, 220, 60	1, 220, 60
Communication Cable		mm ² x No.	1.0 - 1.5 x 2C	1.0 - 1.5 x 2C
Decoration Panel (Accessory)	Model Name		PT-UUC (Grill) PT-UUD (Panel)	PT-UUC (Grill) PT-UUD (Panel)
	Exterior Color		Noble White	Noble White
	RAL Code		RAL 9003	RAL 9003
	Net Dimensions (W x H x D)	mm	1,100 x 34 x 500 1,100 x 34 x 500	1,100 x 34 x 500 1,100 x 34 x 500
	Net Weight	kg	4.6 / 5.3	4.6 / 5.3

※ Nominal : Performance tested under EN14511
 ※ Rated : Max. power input allowed for fan motor
 Note : 1. Capacities are based on the following conditions
 - Cooling : Indoor temp. 27°C (80.6°F) DB / 19°C (66.2°F) WB, Outdoor temp. 35°C (95°F) DB / 24°C (75.2°F) WB, Interconnecting piping length 7.5m, Level difference of zero
 - Heating : Indoor temp. 20°C (68°F) DB / 15°C (59°F) WB, Outdoor temp. 7°C (44.6°F) DB / 6°C (42.8°F) WB, Interconnecting piping length 7.5m, Level difference of zero
 2. Due to our policy of innovation some specifications may be changed without notification
 3. I.D : 'Internal Diameter'

Accessories

Chassis	ARNU07GTUD4	ARNU09GTUD4	ARNU12GTUD4
Drain Pump		○	
Cassette Cover		-	
Refrigerant Leakage Detector		PRLDNV50	
EEV Kit		PRGK024A0	
Independent Power Module		PRIP0	
Robot Cleaner		-	
Pre Filter (Washable / Anti-fungus)		○	
Ion Generator		-	
CO ₂ Sensor		-	
Ventilation Kit		-	
IR Receiver		-	
Zone Controller		-	
Dry Contact (with Additional Accessory)		PDRYCB000 (1 point contact) PDRYCB300 (8 points for thermostat compatible) NEW PDRYCB320 (Universal input) ¹⁾ PDRYCB400 (2 points input) PDRYCB500 (Modbus)	
External Input (1 point)		○	
Wi-Fi		PWFMD200	

※ ○ : Applied, - : Not applied
 Option : Refer to model name in table
 1) Available from April 2020

ARNU18GTDD4 / ARNU24GTDD4



Model	Unit	ARNU18GTDD4	ARNU24GTDD4
Cooling Capacity	kW	5.6	7.1
Heating Capacity	kW	6.3	7.1
Power Input (H / M / L)	Nominal	W	38 / 28 / 24
			51 / 33 / 26
Dimensions (W x H x D)	Body	mm	1,180 x 132 x 450
	Shipping	mm	1,499 x 259 x 538
Fan	Type		Cross Flow Fan
	Motor Output x Number	W x No.	30 x 1
	Air Flow Rate (H / M / L)	m ³ /min	13.3 / 12.1 / 10.9
	Motor Type		BLDC
Air Filter			Pre Filter
Pipe Connections	Liquid Side	mm (inch)	Ø6.35 (1/4)
	Gas Side	mm (inch)	Ø12.7 (1/2)
	Drain Pipe (Internal Dia.)	mm (inch)	Ø25 (1)
Weight	Body	kg	15.6
Sound Pressure Levels (H / M / L)		dB(A)	40 / 37 / 35
Sound Power Levels (H / M / L)		dB(A)	56 / 51 / 48
Power Supply		∅, V, Hz	1, 220 - 240, 50
			1, 220, 60
Communication Cable		mm ² x No.	1.0 - 1.5 x 2C
Decoration Panel (Accessory)	Model Name		PT-UTC (Grill) PT-UTD (Panel)
	Exterior Color		Noble White
	RAL Code		RAL 9003
	Net Dimensions (W x H x D)	mm	1,420 x 34 x 500 1,420 x 34 x 500
	Net Weight	kg	5.5 / 6.5

※ Nominal : Performance tested under EN14511
 ※ Rated : Max. power input allowed for fan motor
 Note : 1. Capacities are based on the following conditions
 - Cooling : Indoor temp. 27°C (80.6°F) DB / 19°C (66.2°F) WB, Outdoor temp. 35°C (95°F) DB / 24°C (75.2°F) WB, Interconnecting piping length 7.5m, Level difference of zero
 - Heating : Indoor temp. 20°C (68°F) DB / 15°C (59°F) WB, Outdoor temp. 7°C (44.6°F) DB / 6°C (42.8°F) WB, Interconnecting piping length 7.5m, Level difference of zero
 2. Due to our policy of innovation some specifications may be changed without notification
 3. I.D : 'Internal Diameter'

Accessories

Chassis	ARNU18GTDD4	ARNU24GTDD4
Drain Pump		○
Cassette Cover		-
Refrigerant Leakage Detector		PRLDNV50
EEV Kit		-
Independent Power Module		PRIP0
Robot Cleaner		-
Pre Filter (Washable / Anti-fungus)		○
Ion Generator		-
CO ₂ Sensor		-
Ventilation Kit		-
IR Receiver		-
Zone Controller		-
Dry Contact (with Additional Accessory)		PDRYCB000 (1 point contact) PDRYCB300 (8 points for thermostat compatible) NEW PDRYCB320 (Universal input) ¹⁾ PDRYCB400 (2 points input) PDRYCB500 (Modbus)
External Input (1 point)		○
Wi-Fi		PWFMD200

※ ○ : Applied, - : Not applied
 Option : Refer to model name in table
 1) Available from April 2020

CEILING CONCEALED DUCT



Features & Benefits

- E.S.P. control function can make air volume controlled easily with remote controller.

Key Applications

- Hotel / Conference Center
- Retail / Shopping Center
- School
- Office
- Restaurant
- Church
- Historic Building

	Duct	High	Middle	Low
Smart	Wi-Fi	○	○	○
Energy Efficiency	E.S.P. Control	○	○	○
	Drain Pump	○	○	○
	Timer (On / Off)	○	○	○
Comfort	Timer (Weekly)	○	○	○
	Two Thermistor Control	○	○	○
	Group Control	○	○	○

※ ○ : Applied, - : Not applied

E.S.P.(External Static Pressure) Control

User has an easy access to air volume selection via remote controller secured by the E.S.P. control function. The BLDC motor can control fan speed and air volume regardless of the external static pressure. No additional accessories are necessary to control air flow.

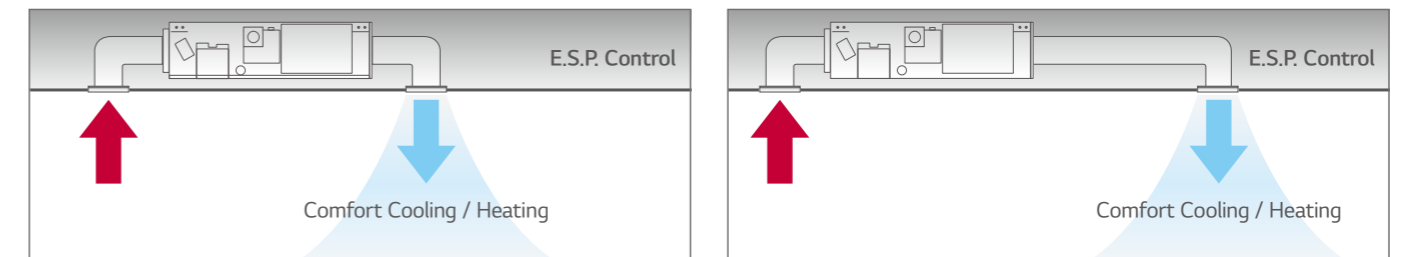

Static Pressure 11 Steps Control

Depending on the installation environment, 4 series ceiling concealed duct is controlled the static pressure to 11 step, for providing comfortable environment suitable for any case scenario.

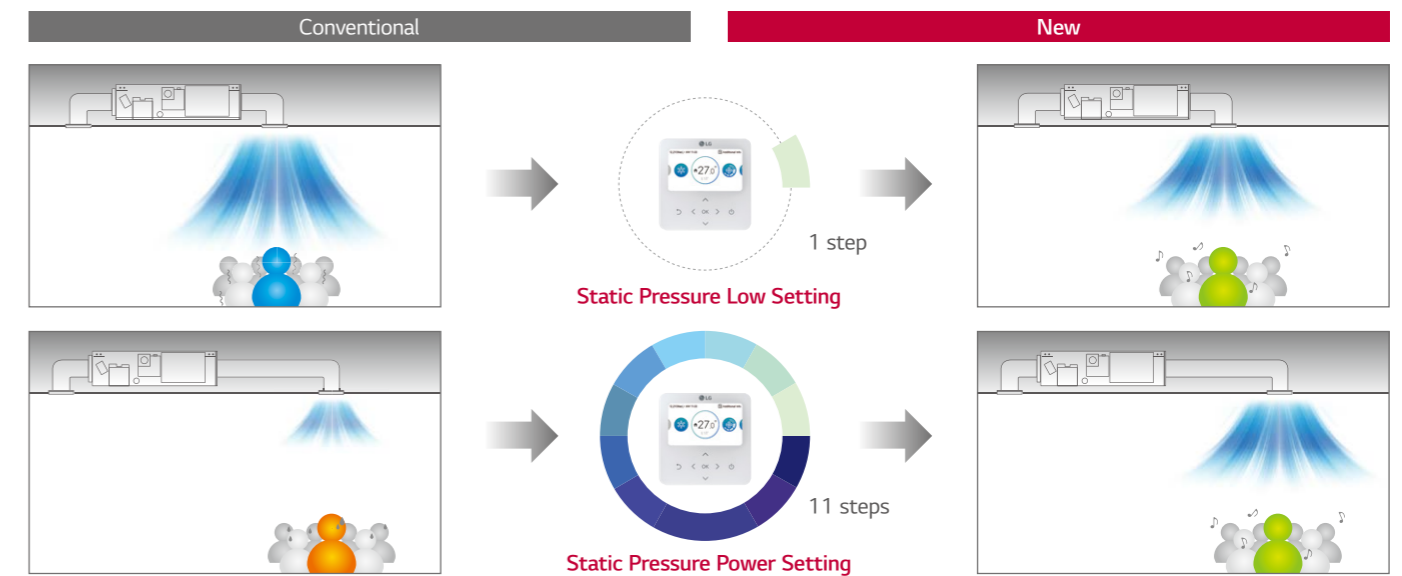

Operation for Multiple Rooms

Using a spiral duct (Embedded or Flexible type) and stream chamber, it is possible to operate cooling / heating for several rooms simultaneously.

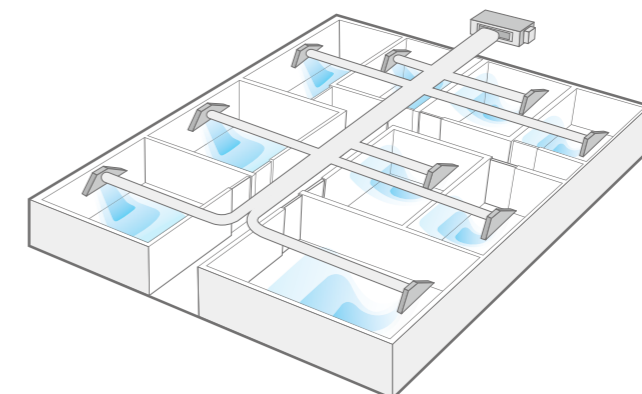

CEILING CONCEALED DUCT

Minimized Height

New mid-static ducts provide ideal solution for installation in limited space.

8 / 10kW

12.5kW

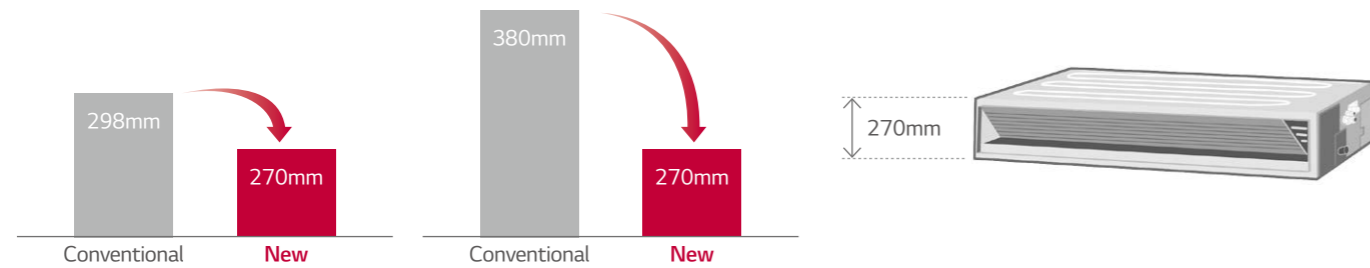

Two Thermistors Control

The indoor temperature can be checked using the thermi-stors in the remote controller as well as from the indoor unit. There may be a significant difference between ceiling and floor air temperature. Two thermistors can optimize indoor air temperature for a more comfortable environment.

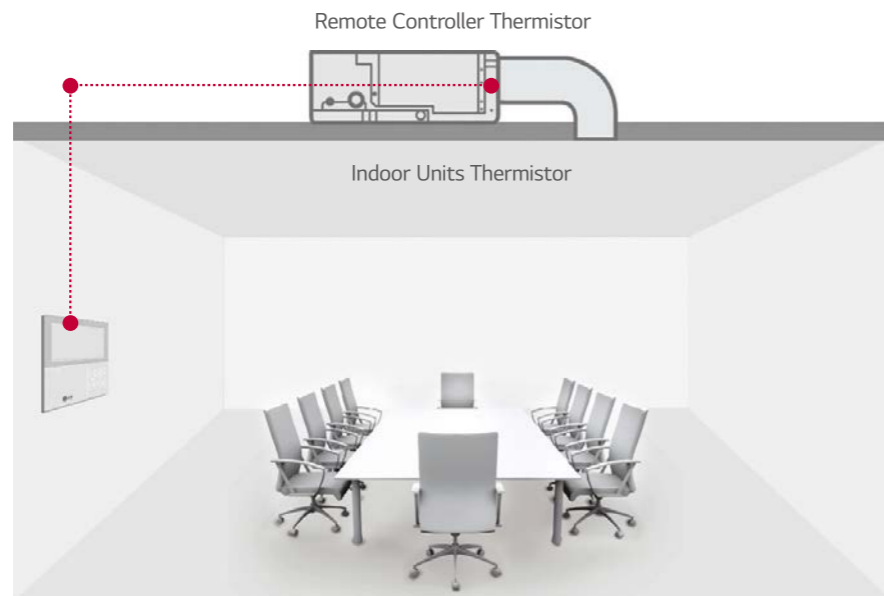

Flexible Installation (Low Static Duct Only)

The low static duct allows the air intake at the rear or bottom under installation condition.

Air intake at the rear or bottom

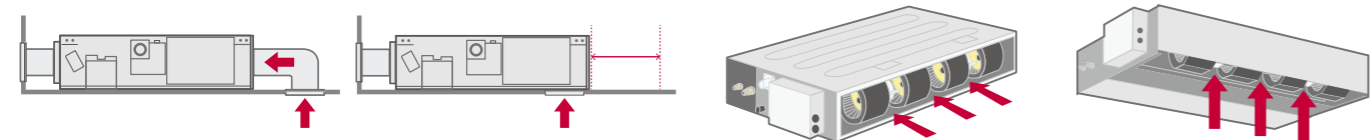

HIGH STATIC

ARNU07GM1A4 / ARNU09GM1A4 / ARNU12GM1A4



Model	Unit	ARNU07GM1A4	ARNU09GM1A4	ARNU12GM1A4
Cooling Capacity	kW	2.2	2.8	3.6
Heating Capacity	kW	2.5	3.2	4.0
Power Input (H / M / L)	Nominal W	39 / 30 / 25	40 / 32 / 26	46 / 38 / 31
Dimensions (W x H x D)	Body	mm	900 x 270 x 700	900 x 270 x 700
	Shipping	mm	1,100 x 338 x 773	1,100 x 338 x 773
Fan	Type		Sirocco Fan	Sirocco Fan
	Motor Output x Number	W x No.	136 x 1	136 x 1
	Air Flow Rate (H / M / L)	m ³ /min	9.0 / 7.5 / 6.0	9.5 / 7.5 / 6.0
	External Static Pressure (High Mode)	mmAq (Pa)	6 (59)	6 (59)
	Air Flow Rate (H / M / L) (Standard Mode)	m ³ /min	9.0 / 7.5 / 6.0	9.5 / 7.5 / 6.0
	External Static Pressure (Standard Mode)	mmAq (Pa)	2.5 (25)	2.5 (25)
	Motor Type		BLDC	BLDC
Air Filter		Pre Filter	Pre Filter	Pre Filter
Pipe Connections	Liquid Side	mm (inch)	Ø6.35 (1/4)	Ø6.35 (1/4)
	Gas Side	mm (inch)	Ø12.7 (1/2)	Ø12.7 (1/2)
	Drain Pipe (Internal Dia.)	mm (inch)	25 (1)	25 (1)
Weight	Body kg	25.5	25.5	25.5
Sound Pressure Levels (H / M / L)	dB(A)	26 / 24 / 23	27 / 25 / 23	27 / 25 / 23
Sound Power Levels (H / M / L)	dB(A)	55 / 54 / 51	55 / 54 / 52	56 / 54 / 52
Power Supply	Ø, V, Hz	1, 220 - 240, 50	1, 220 - 240, 50	1, 220 - 240, 50
		1, 220, 60	1, 220, 60	1, 220, 60
Communication Cable	mm ² x No.	1.0 - 1.5 x 2C	1.0 - 1.5 x 2C	1.0 - 1.5 x 2C

※ Nominal : Performance tested under EN14511

※ Rated : Max. power input allowed for fan motor

Note : 1. Capacities are based on the following conditions

- Cooling : Indoor temp. 27°C (80.6°F) DB / 19°C (66.2°F) WB, Outdoor temp. 35°C (95°F) DB / 24°C (75.2°F) WB, Interconnecting piping length 7.5m, Level difference of zero

- Heating : Indoor temp. 20°C (68°F) DB / 15°C (59°F) WB, Outdoor temp. 7°C (44.6°F) DB / 6°C (42.8°F) WB, Interconnecting piping length 7.5m, Level difference of zero

2. Due to our policy of innovation some specifications may be changed without notification

3. I.D : 'Internal Diameter'

4. The Sound Pressure test condition is based on 50 Pa for middle static duct.

Accessories

Chassis	ARNU07GM1A4	ARNU09GM1A4	ARNU12GM1A4
Drain Pump		○	
Cassette Cover		-	
Refrigerant Leakage Detector		PRLDNVS0	
EEV Kit		PRGK024A0 (-5.6kW)	
Independent Power Module		PRIP0	
Robot Cleaner		-	
Pre Filter (Washable / Anti-fungus)		○	
Ion Generator		-	
CO ₂ Sensor		-	
Ventilation Kit		-	
IR Receiver		PWLRVN000	
Zone Controller		ABZCA	
Dry Contact (with Additional Accessory)		PDRYCB000 (1 point contact) PDRYCB300 (8 points for thermostat compatible) NEW PDRYCB320 (Universal input) ¹⁾ PDRYCB400 (2 points input) PDRYCB500 (Modbus)	
External Input (1 point)		○	
Wi-Fi		PWFMD200	

※ ○ : Applied, - : Not applied

Option : Refer to model name in table

1) Available from April 2020

HIGH STATIC

ARNU15GM1A4 / ARNU18GM1A4 / ARNU24GM1A4



Model	Unit	ARNU15GM1A4	ARNU18GM1A4	ARNU24GM1A4
Cooling Capacity	kW	4.5	5.6	7.1
Heating Capacity	kW	5.0	6.3	8.0
Power Input (H / M / L)	Nominal	W	67 / 53 / 46	85 / 63 / 55
Dimensions (W x H x D)	Body	mm	900 x 270 x 700	900 x 270 x 700
	Shipping	mm	1,100 x 338 x 773	1,100 x 338 x 773
Fan	Type		Sirocco Fan	Sirocco Fan
	Motor Output x Number	W x No.	136 x 1	136 x 1
	Air Flow Rate (H / M / L)	m ³ /min	16.0 / 12.0 / 9.0	17.0 / 14.5 / 12.0
	External Static Pressure (High Mode)	mmAq (Pa)	6 (59)	6 (59)
	Air Flow Rate (H / M / L) (Standard Mode)	m ³ /min	16.0 / 12.0 / 9.0	17.0 / 14.5 / 12.0
	External Static Pressure (Standard Mode)	mmAq (Pa)	2.5 (25)	2.5 (25)
	Motor Type		BLDC	BLDC
Air Filter		Pre Filter	Pre Filter	Pre Filter
Pipe Connections	Liquid Side	mm (inch)	Ø6.35 (1/4)	Ø9.52 (3/8)
	Gas Side	mm (inch)	Ø12.7 (1/2)	Ø15.88 (5/8)
	Drain Pipe (Internal Dia.)	mm (inch)	Ø25 (1)	Ø25 (1)
Weight	Body	kg	25.5	26.5
Sound Pressure Levels (H / M / L)		dB(A)	30 / 27 / 23	31 / 28 / 25
Sound Power Levels (H / M / L)		dB(A)	59 / 57 / 55	59 / 57 / 55
Power Supply	Ø, V, Hz		1, 220 ~ 240, 50	1, 220 ~ 240, 50
			1, 220, 60	1, 220, 60
Communication Cable	mm ² x No.		1.0 ~ 1.5 x 2C	1.0 ~ 1.5 x 2C

※ Nominal : Performance tested under EN14511

※ Rated : Max. power input allowed for fan motor

Note : 1. Capacities are based on the following conditions

- Cooling : Indoor temp. 27°C (80.6°F) DB / 19°C (66.2°F) WB, Outdoor temp. 35°C (95°F) DB / 24°C (75.2°F) WB, Interconnecting piping length 7.5m, Level difference of zero

- Heating : Indoor temp. 20°C (68°F) DB / 15°C (59°F) WB, Outdoor temp. 7°C (44.6°F) DB / 6°C (42.8°F) WB, Interconnecting piping length 7.5m, Level difference of zero

2. Due to our policy of innovation some specifications may be changed without notification

3. I.D : 'Internal Diameter'

4. The Sound Pressure test condition is based on 50 Pa for middle static duct.

Accessories

Chassis	ARNU15GM1A4	ARNU18GM1A4	ARNU24GM1A4
Drain Pump		○	
Cassette Cover		-	
Refrigerant Leakage Detector		PRLDNV50	
EEV Kit		PRGK024A0 (-5.6kW)	
Independent Power Module		PRIP0	
Robot Cleaner		-	
Pre Filter (Washable / Anti-fungus)		○	
Ion Generator		-	
CO ₂ Sensor		-	
Ventilation Kit		-	
IR Receiver		PWLRVN000	
Zone Controller		ABZCA	
Dry Contact (with Additional Accessory)		PDRYCB000 (1 point contact) PDRYCB300 (8 points for thermostat compatible) NEW PDRYCB320 (Universal input) ¹⁾ PDRYCB400 (2 points input) PDRYCB500 (Modbus)	
External Input (1 point)		○	
Wi-Fi		PWFMD200	

※ ○ : Applied, - : Not applied

Option : Refer to model name in table

1) Available from April 2020

ARNU28GM2A4 / ARNU36GM2A4 / ARNU42GM2A4

ARNU48GM3A4 / ARNU54GM3A4



Model	Unit	ARNU28GM2A4	ARNU36GM2A4	ARNU42GM2A4	ARNU48GM3A4	ARNU54GM3A4
Cooling Capacity	kW	8.2	10.6	12.3	14.1	15.8
Heating Capacity	kW	9.2	11.9	13.8	15.9	18.0
Power Input (H / M / L)	Nominal	W	123 / 81 / 57	184 / 123 / 81	231 / 162 / 111	172 / 105 / 65
Dimensions (W x H x D)	Body	mm	1,250 x 270 x 700	1,250 x 270 x 700	1,250 x 270 x 700	1,250 x 360 x 700
	Shipping	mm	1,450 x 338 x 773	1,450 x 338 x 773	1,450 x 338 x 773	1,450 x 428 x 773
Fan	Type		Sirocco Fan	Sirocco Fan	Sirocco Fan	Sirocco Fan
	Motor Output x Number	W x No.	350 x 1	350 x 1	350 x 1	350 x 1
	Air Flow Rate (H / M / L)	m ³ /min	28.0 / 24.0 / 21.0	32.0 / 28.0 / 24.0	38.0 / 33.0 / 28.0	40.0 / 34.0 / 28.0
	External Static Pressure (High Mode)	mmAq (Pa)	6 (59)	6 (59)	6 (59)	6 (59)
	Air Flow Rate (H / M / L) (Standard Mode)	m ³ /min	28.0 / 24.0 / 21.0	32.0 / 28.0 / 24.0	38.0 / 33.0 / 28.0	40.0 / 34.0 / 28.0
	External Static Pressure (Standard Mode)	mmAq (Pa)	5 (49)	5 (49)	5 (49)	5 (49)
	Motor Type		BLDC	BLDC	BLDC	BLDC
Air Filter		Pre Filter	Pre Filter	Pre Filter	Pre Filter	Pre Filter
Pipe Connections	Liquid Side	mm (inch)	Ø9.52 (3/8)	Ø9.52 (3/8)	Ø9.52 (3/8)	Ø9.52 (3/8)
	Gas Side	mm (inch)	Ø15.88 (5/8)	Ø15.88 (5/8)	Ø15.88 (5/8)	Ø19.05 (3/4)
	Drain Pipe (Internal Dia.)	mm (inch)	Ø25 (1)	Ø25 (1)	Ø25 (1)	Ø25 (1)
Weight	Body	kg	38.0	38.0	39.5	44.0
Sound Pressure Levels (H / M / L)		dB(A)	36 / 34 / 33	37 / 36 / 34	38 / 37 / 36	39 / 37 / 35
Sound Power Levels (H / M / L)		dB(A)	59 / 57 / 55	60 / 59 / 57	62 / 61 / 60	63 / 60 / 59
Power Supply	Ø, V, Hz		1, 220 ~ 240, 50	1, 220 ~ 240, 50	1, 220 ~ 240, 50	1, 220 ~ 240, 50
			1, 220, 60	1, 220, 60	1, 220, 60	1, 220, 60
Communication Cable	mm ² x No.		1.0 ~ 1.5 x 2C	1.0 ~ 1.5 x 2C	1.0 ~ 1.5 x 2C	1.0 ~ 1.5 x 2C

※ Nominal : Performance tested under EN14511

※ Rated : Max. power input allowed for fan motor

Note : 1. Capacities are based on the following conditions

- Cooling : Indoor temp. 27°C (80.6°F) DB / 19°C (66.2°F) WB, Outdoor temp. 35°C (95°F) DB / 24°C (75.2°F) WB, Interconnecting piping length 7.5m, Level difference of zero

- Heating : Indoor temp. 20°C (68°F) DB / 15°C (59°F) WB, Outdoor temp. 7°C (44.6°F) DB / 6°C (42.8°F) WB, Interconnecting piping length 7.5m, Level difference of zero

2. Due to our policy of innovation some specifications may be changed without notification

3. I.D : 'Internal Diameter'

4. The Sound Pressure test condition is based on 50 Pa for middle static duct.

Accessories

Chassis	ARNU28GM2A4	ARNU36GM2A4	ARNU42GM2A4	ARNU48GM3A4	ARNU54GM3A4
Drain Pump				○	
Cassette Cover				-	
Refrigerant Leakage Detector				PRLDNV50	
EEV Kit				-	
Independent Power Module				PRIP0	
Robot Cleaner				-	
Pre Filter (Washable / Anti-fungus)				○	
Ion Generator				-	
CO ₂ Sensor				-	
Ventilation Kit				-	
IR Receiver				PWLRVN000	
Zone Controller				ABZCA	
Dry Contact (with Additional Accessory)				PDRYCB000 (1 point contact) PDRYCB300 (8 points for thermostat compatible) NEW PDRYCB320 (Universal input) ¹⁾ PDRYCB400 (2 points input) PDRYCB500 (Modbus)	
External Input (1 point)				○	
Wi-Fi				PWFMD200	

※ ○ : Applied, - : Not applied

Option : Refer to model name in table

1) Available from April 2020

HIGH STATIC

ARNU48GM3B4 / ARNU54GM3B4 / ARNU76GB8A4 / ARNU96GB8A4



Model	Unit	ARNU48GM3B4	ARNU54GM3B4	ARNU76GB8A4	ARNU96GB8A4	
Cooling Capacity	kW	14.1	15.8	22.4	28.0	
Heating Capacity	kW	15.9	18.0	25.2	31.5	
Power Input (H / M / L)	Nominal	W	172 / 105 / 65	260 / 215 / 172	765 / 500 / 500	800 / 750 / 750
	Dimensions (W x H x D)	mm	1,250 x 360 x 700	1,250 x 360 x 700	1,562 x 460 x 688	1,562 x 460 x 688
Dimensions (W x H x D)	Shipping	mm	1,450 x 428 x 773	1,560 x 415 x 770	1,806 x 537 x 825	1,806 x 537 x 825
	Type		Sirocco Fan	Sirocco Fan	Sirocco Fan	Sirocco Fan
Fan	Motor Output x Number	W x No.	500 x 1	500 x 1	375 x 2	375 x 2
	Air Flow Rate (H / M / L) (High Mode-Factory Set)	m³/min	40.0 / 34.0 / 28.0	50.0 / 45.0 / 40.0	60.0 / 50.0 / 50.0	72.0 / 64.0 / 64.0
	External Static Pressure (High Mode)	mmAq (Pa)	6 (59)	6 (59)	22 (216)	22 (216)
	Air Flow Rate (H / M / L) (Standard Mode)	m³/min	40.0 / 34.0 / 28.0	50.0 / 45.0 / 40.0	64.0 / 50.0 / 50.0	76.0 / 64.0 / 64.0
	External Static Pressure (Standard Mode)	mmAq (Pa)	5 (49)	5 (49)	15 (147)	15 (147)
	Motor Type		BLDC	BLDC	BLDC	BLDC
Air Filter		-	-	Pre Filter	Pre Filter	
Pipe Connections	Liquid Side	mm (inch)	Ø9.52 (3/8)	Ø9.52 (3/8)	Ø9.52 (3/8)	Ø9.52 (3/8)
	Gas Side	mm (inch)	Ø15.88 (5/8)	Ø19.05 (3/4)	Ø19.05 (3/4)	Ø22.2 (7/8)
	Drain Pipe (Internal Dia.)	mm (inch)	Ø25 (1)	Ø25 (1)	Ø25 (1)	Ø25 (1)
Weight	Body	kg	44.0	44.0	87.0	87.0
	Power Supply	∅, V, Hz	1, 220 - 240, 50	1, 220 - 240, 50	1, 220 - 240, 50	1, 220 - 240, 50
Communication Cable		mm² x No.	1.0 - 1.5 x 2C	1.0 - 1.5 x 2C	1.0 - 1.5 x 2C	1.0 - 1.5 x 2C

※ Nominal : Performance tested under EN14511

※ Rated : Max. power input allowed for fan motor

Note : 1. Capacities are based on the following conditions

- Cooling : Indoor temp. 27°C (80.6°F) DB / 19°C (66.2°F) WB, Outdoor temp. 35°C (95°F) DB / 24°C (75.2°F) WB, Interconnecting piping length 7.5m, Level difference of zero
- Heating : Indoor temp. 20°C (68°F) DB / 15°C (59°F) WB, Outdoor temp. 7°C (44.6°F) DB / 6°C (42.8°F) WB, Interconnecting piping length 7.5m, Level difference of zero

2. Due to our policy of innovation some specifications may be changed without notification

3. I.D : 'Internal Diameter'

4. The Sound Pressure test condition is based on 50 Pa for middle static duct.

Accessories

Chassis	ARNU48GM3B4	ARNU54GM3B4	ARNU76GB8A4	ARNU96GB8A4
Drain Pump			○	
Cassette Cover			-	
Refrigerant Leakage Detector			PRLDNV50	
EEV Kit			○	
Independent Power Module			PRIP0	
Robot Cleaner			-	
Pre Filter (Washable / Anti-fungus)			○	
Ion Generator			-	
CO ₂ Sensor			-	
Ventilation Kit			-	
IR Receiver			PWLRVN000	
Zone Controller			ABZCA	
Dry Contact (with Additional Accessory)			PDRYCB000 (1 point contact) PDRYCB300 (8 points for thermostat compatible) NEW PDRYCB320 (Universal input) ¹⁾ PDRYCB400 (2 points input) PDRYCB500 (Modbus)	
External Input (1 point)			○	
Wi-Fi			PWFMD200	

※ ○ : Applied, - : Not applied

Option : Refer to model name in table

1) Available from April 2020

LOW STATIC

ARNU05GL1G4 / ARNU07GL1G4 / ARNU09GL1G4



Model	Unit	ARNU05GL1G4	ARNU07GL1G4	ARNU09GL1G4	
Cooling Capacity	kW	1.7	2.2	2.8	
Heating Capacity	kW	1.9	2.5	3.2	
Power Input (H / M / L)	Nominal	W	29 / 26 / 24	31 / 28 / 24	39 / 29 / 24
	Dimensions (W x H x D)	mm	700 x 190 x 700	700 x 190 x 700	700 x 190 x 700
Dimensions (W x H x D)	Shipping	mm	862 x 255 x 781	862 x 255 x 781	862 x 255 x 781
	Type		Sirocco Fan	Sirocco Fan	Sirocco Fan
Fan	Motor Output x Number	W x No.	19 x 1	19 x 1	19 x 1
	Air Flow Rate (H / M / L) (High Mode-Factory Set)	m³/min	6.7 / 6.2 / 5.5	7.5 / 6.5 / 5.5	9.0 / 7.0 / 5.5
	External Static Pressure (High Mode)	mmAq (Pa)	2.54 (25)	2.54 (25)	2.54 (25)
	Air Flow Rate (H / M / L) (Standard Mode)	m³/min	6.7 / 6.2 / 5.5	7.5 / 6.5 / 5.5	9.0 / 7.0 / 5.5
	External Static Pressure (Standard Mode)	mmAq (Pa)	0 (0)	0 (0)	0 (0)
	Motor Type		BLDC	BLDC	BLDC
Air Filter		Pre Filter	Pre Filter	Pre Filter	
Pipe Connections	Liquid Side	mm (inch)	Ø6.35 (1/4)	Ø6.35 (1/4)	Ø6.35 (1/4)
	Gas Side	mm (inch)	Ø12.7 (1/2)	Ø12.7 (1/2)	Ø12.7 (1/2)
	Drain Pipe (Internal Dia.)	mm (inch)	Ø25 (1)	Ø25 (1)	Ø25 (1)
Weight	Body	kg	17.5	17.5	17.5
	Sound Pressure Levels (H / M / L)	dB(A)	25 / 24 / 22	26 / 24 / 22	28 / 25 / 22
Sound Power Levels (H / M / L)		dB(A)	48 / 46 / 45	50 / 47 / 45	53 / 49 / 45
	Power Supply	∅, V, Hz	1, 220 - 240, 50	1, 220 - 240, 50	1, 220 - 240, 50
Communication Cable		mm² x No.	1, 220, 60	1, 220, 60	1, 220, 60
			1.0 - 1.5 x 2C	1.0 - 1.5 x 2C	1.0 - 1.5 x 2C

※ Nominal : Performance tested under EN14511

※ Rated : Max. power input allowed for fan motor

Note : 1. Capacities are based on the following conditions

- Cooling : Indoor temp. 27°C (80.6°F) DB / 19°C (66.2°F) WB, Outdoor temp. 35°C (95°F) DB / 24°C (75.2°F) WB, Interconnecting piping length 7.5m, Level difference of zero
- Heating : Indoor temp. 20°C (68°F) DB / 15°C (59°F) WB, Outdoor temp. 7°C (44.6°F) DB / 6°C (42.8°F) WB, Interconnecting piping length 7.5m, Level difference of zero

2. Due to our policy of innovation some specifications may be changed without notification

3. I.D : 'Internal Diameter'

4. L2, L3 : The Sound Pressure test condition is based on 20 Pa (Static Pressure) as standard.

Accessories

Chassis	ARNU05GL1G4	ARNU07GL1G4	ARNU09GL1G4
Drain Pump			○
Cassette Cover			-
Refrigerant Leakage Detector			PRLDNV50
EEV Kit			PRGK024A0
Independent Power Module			PRIP0
Robot Cleaner			-
Pre Filter (Washable / Anti-fungus)			○
Ion Generator			-
CO ₂ Sensor			-
Ventilation Kit			-
IR Receiver			PWLRVN000
Zone Controller			ABZCA
Dry Contact (with Additional Accessory)			PDRYCB000 (1 point contact) PDRYCB300 (8 points for thermostat compatible) NEW PDRYCB320 (Universal input) ¹⁾ PDRYCB400 (2 points input) PDRYCB500 (Modbus)
External Input (1 point)			○
Wi-Fi			PWFMD200

※ ○ : Applied, - : Not applied

Option : Refer to model name in table

1) Available from April 2020

LOW STATIC

ARNU12GL2G4 / ARNU15GL2G4 / ARNU18GL2G4



Model	Unit	ARNU12GL2G4	ARNU15GL2G4	ARNU18GL2G4
Cooling Capacity	kW	3.6	4.5	5.6
Heating Capacity	kW	4.0	5.0	6.3
Power Input (H / M / L)	Nominal	W	41 / 34 / 29	56 / 41 / 34
Dimensions (W x H x D)	Body	mm	900 x 190 x 700	900 x 190 x 700
	Shipping	mm	1,062 x 255 x 781	1,062 x 255 x 781
Fan	Type		Sirocco Fan	Sirocco Fan
	Motor Output x Number	W x No.	19 x 1, 5 x 1	19 x 1, 5 x 1
	Air Flow Rate (H / M / L) (High Mode-Factory Set)	m³/min	10.0 / 8.5 / 7.0	12.5 / 10.0 / 8.5
	External Static Pressure (High mode)	mmAq (Pa)	2.54 (25)	2.54 (25)
	Air Flow Rate (H / M / L) (Standard Mode)	m³/min	10.0 / 8.5 / 7.0	12.5 / 10.0 / 8.5
	External Static Pressure (Standard Mode)	mmAq (Pa)	0 (0)	0 (0)
	Motor Type		BLDC	BLDC
Air Filter		Pre Filter	Pre Filter	Pre Filter
Pipe Connections	Liquid Side	mm (inch)	Ø6.35 (1/4)	Ø6.35 (1/4)
	Gas Side	mm (inch)	Ø12.7 (1/2)	Ø12.7 (1/2)
	Drain Pipe (Internal Dia.)	mm (inch)	Ø25 (1)	Ø25 (1)
Weight	Body	kg	23.0	23.0
Sound Pressure Levels (H / M / L)		dB(A)	30 / 27 / 25	33 / 30 / 28
Sound Power Levels (H / M / L)		dB(A)	50 / 47 / 46	54 / 51 / 47
Power Supply	Ø, V, Hz		1, 220 - 240, 50	1, 220 - 240, 50
			1, 220, 60	1, 220, 60
Communication Cable	mm² x No.		1.0 - 1.5 x 2C	1.0 - 1.5 x 2C

※ Nominal : Performance tested under EN14511
 ※ Rated : Max. power input allowed for fan motor
 Note : 1. Capacities are based on the following conditions
 - Cooling : Indoor temp. 27°C (80.6°F) DB / 19°C (66.2°F) WB, Outdoor temp. 35°C (95°F) DB / 24°C (75.2°F) WB, Interconnecting piping length 7.5m, Level difference of zero
 - Heating : Indoor temp. 20°C (68°F) DB / 15°C (59°F) WB, Outdoor temp. 7°C (44.6°F) DB / 6°C (42.8°F) WB, Interconnecting piping length 7.5m, Level difference of zero
 2. Due to our policy of innovation some specifications may be changed without notification
 3. I.D : 'Internal Diameter'
 4. L2, L3 : The Sound Pressure test condition is based on 20 Pa (Static Pressure) as standard.

Accessories

Chassis	ARNU12GL2G4	ARNU15GL2G4	ARNU18GL2G4
Drain Pump		○	
Cassette Cover		-	
Refrigerant Leakage Detector		PRLDNV50	
EEV Kit		○	
Independent Power Module		PRIP0	
Robot Cleaner		-	
Pre Filter (Washable / Anti-fungus)		○	
Ion Generator		-	
CO ₂ Sensor		-	
Ventilation Kit		-	
IR Receiver		PWLRVN000	
Zone Controller		ABZCA	
Dry Contact (with Additional Accessory)		PDRYCB000 (1 point contact) PDRYCB300 (8 points for thermostat compatible) NEW PDRYCB320 (Universal input) ¹⁾ PDRYCB400 (2 points input) PDRYCB500 (Modbus)	
External Input (1 point)		○	
Wi-Fi		PWFMD200	

※ ○ : Applied, - : Not applied
 Option : Refer to model name in table
 1) Available from April 2020

ARNU21GL3G4 / ARNU24GL3G4



Model	Unit	ARNU21GL3G4	ARNU24GL3G4
Cooling Capacity	kW	6.2	7.1
Heating Capacity	kW	7.0	8.0
Power Input (H / M / L)	Nominal	W	72 / 53 / 48
Dimensions (W x H x D)	Body	mm	1,100 x 190 x 700
	Shipping	mm	1,262 x 255 x 781
Fan	Type		Sirocco Fan
	Motor Output x Number	W x No.	19 x 2
	Air Flow Rate (H / M / L) (High Mode-Factory Set)	m³/min	17.5 / 14.0 / 12.0
	External Static Pressure (High Mode)	mmAq (Pa)	2.54 (25)
	Air Flow Rate (H / M / L) (Standard mode)	m³/min	17.5 / 14.0 / 12.0
	External Static Pressure (Standard Mode)	mmAq (Pa)	0 (0)
	Motor Type		BLDC
Air Filter		Pre Filter	Pre Filter
Pipe Connections	Liquid Side	mm (inch)	Ø9.52 (3/8)
	Gas Side	mm (inch)	Ø15.88 (5/8)
	Drain Pipe (Internal Dia.)	mm (inch)	Ø25 (1)
Weight	Body	kg	27.0
Sound Pressure Levels (H / M / L)		dB(A)	35 / 29 / 28
Sound Power Levels (H / M / L)		dB(A)	59 / 55 / 54
Power Supply	Ø, V, Hz		1, 220 - 240, 50
			1, 220, 60
Communication Cable	mm² x No.		1.0 - 1.5 x 2C

※ Nominal : Performance tested under EN14511
 ※ Rated : Max. power input allowed for fan motor
 Note : 1. Capacities are based on the following conditions
 - Cooling : Indoor temp. 27°C (80.6°F) DB / 19°C (66.2°F) WB, Outdoor temp. 35°C (95°F) DB / 24°C (75.2°F) WB, Interconnecting piping length 7.5m, Level difference of zero
 - Heating : Indoor temp. 20°C (68°F) DB / 15°C (59°F) WB, Outdoor temp. 7°C (44.6°F) DB / 6°C (42.8°F) WB, Interconnecting piping length 7.5m, Level difference of zero
 2. Due to our policy of innovation some specifications may be changed without notification
 3. I.D : 'Internal Diameter'
 4. L2, L3 : The Sound Pressure test condition is based on 20 Pa (Static Pressure) as standard.

Accessories

Chassis	ARNU21GL3G4	ARNU24GL3G4
Drain Pump		○
Cassette Cover		-
Refrigerant Leakage Detector		PRLDNV50
EEV Kit		-
Independent Power Module		PRIP0
Robot Cleaner		-
Pre Filter (Washable / Anti-fungus)		○
Ion Generator		-
CO ₂ Sensor		-
Ventilation Kit		-
IR Receiver		PWLRVN000
Zone Controller		ABZCA
Dry Contact (with Additional Accessory)		PDRYCB000 (1 point contact) PDRYCB300 (8 points for thermostat compatible) NEW PDRYCB320 (Universal input) ¹⁾ PDRYCB400 (2 points input) PDRYCB500 (Modbus)
External Input (1 point)		○
Wi-Fi		PWFMD200

※ ○ : Applied, - : Not applied
 Option : Refer to model name in table
 1) Available from April 2020

LOW STATIC

ARNU07GL4G4 / ARNU09GL4G4 / ARNU12GL5G4

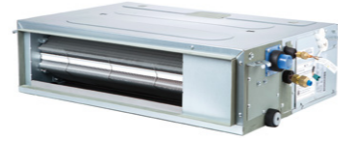

Model	Unit	ARNU07GL4G4	ARNU09GL4G4	ARNU12GL5G4	
Cooling Capacity	kW	2.2	2.8	3.6	
	kcal/h	1,900	2,400	3,100	
	Btu/h	7,500	9,600	12,300	
Heating Capacity	kW	2.5	3.2	4.0	
	kcal/h	2,200	2,800	3,400	
	Btu/h	8,500	10,900	13,600	
Casing		Galvanized Steel Plate	Galvanized Steel Plate	Galvanized Steel Plate	
Dimensions (W x H x D)	Body	700 x 190 x 460	700 x 190 x 460	900 x 190 x 460	
		27.5 x 7.5 x 18.2	27.5 x 7.5 x 18.2	35.4 x 7.5 x 18.2	
Coil	Rows x Columns x FPI	(2 x 6 x 14) x 2	(2 x 6 x 14) x 2	(2 x 6 x 18) x 2	
	Face Area	0.12	0.12	0.17	
Fan	Type	Sirocco Fan	Sirocco Fan	Sirocco Fan	
	Motor Output x Number	W x EA	19 x 1	19 x 1+5x 1	
	Running Current	A	0.4	0.76	
	Air Flow Rate (H / M / L) (High Mode-Factory set)	CMM	7.5 / 6.5 / 5.5	9.0 / 7.0 / 5.5	10.0 / 8.5 / 7.0
		cfm	270 / 230 / 200	320 / 250 / 200	360 / 310 / 250
		External Static Pressure	mmAq (Pa)	1 (10)	1 (10)
	Air Flow Rate (H / M / L) (Standard Mode)	CMM	7.5 / 6.5 / 5.5	9.0 / 7.0 / 5.5	10.0 / 8.5 / 7.0
		cfm	270 / 230 / 200	320 / 250 / 200	360 / 310 / 250
		External Static Pressure	mmAq (Pa)	0 (0)	0 (0)
	Drive		Direct	Direct	Direct
Motor Type		BLDC	BLDC	BLDC	
Temperature Control		Microprocessor Thermostat for cooling and heating	Microprocessor Thermostat for cooling and heating	Microprocessor Thermostat for cooling and heating	
Sound Absorbing Thermal Insulation Material		Foamed polystyrene	Foamed polystyrene	Foamed polystyrene	
Air Filter		-	-	-	
Safety Filter		Fuse	Fuse	Fuse	
Pipe Connections	Liquid Side	mm (inch)	6.35 (1/4)	6.35 (1/4)	
	Gas Side	mm (inch)	12.7 (1/2)	12.7 (1/2)	
	Drain Pipe (Internal Dia.)	mm	25.0	25.0	
Net Weight	kg (lbs)	14.6 (32.2)	14.6 (32.2)	20 (44.1)	
Gross Weight	kg (lbs)	17.8 (39.0)	17.8 (39.0)	22.2 (49.0)	
Noise Level (Sound Pressure, H / M / L)	dB(A)	27 / 26 / 23	30 / 26 / 23	31 / 29 / 26	
Power Supply	Ø, V, Hz	1, 220 - 240, 50	1, 220 - 240, 50	1, 220 - 240, 50	
Refrigerant Control		EEV	EEV	EEV	
Power Cable	mm ²	CV2.5 x 3C	CV2.5 x 3C	CV2.5 x 3C	
communication Cable	mm ²	1.0 - 1.5 x 2C	1.0 - 1.5 x 2C	1.0 - 1.5 x 2C	

Note : 1. Capacities are based on the following conditions :

- Cooling : Indoor temp. 27°C(80.6°F) DB / 19°C(66.2°F) WB
Outdoor temp. 35°C(95°F) DB / 24°C(75.2°F) WB
- Heating : Indoor temp.Indoor 20°C(68°F) DB / 15°C(59°F) WB
Outdoor temp. 7°C(44.6°F) DB / 6°C(42.8°F) WB
- Piping Length : Interconnected Pipe Length = 7.5m
- Difference Limit of Elevation (Outdoor - Indoor Unit) is Zero.

2. Capacities are net capacities

3. Due to our policy of innovation some specifications may be changed without prior notification

4. To be added for more available Models

5. EEV : Electronic Expansion Valve

6. Noise Level is Standard Mode (for actual High Mode (factory set) condition,Noise level may exceed the standard level by 1.5dB(A)

ARNU15GL5G4 / ARNU18GL5G4 / ARNU24GL6G4

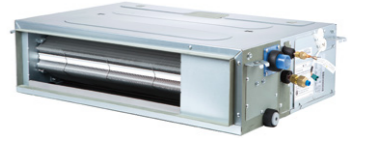

Model	Unit	ARNU15GL5G4	ARNU18GL5G4	ARNU24GL6G4	
Cooling Capacity	kW	4.5	5.6	7.1	
	kcal/h	3,900	4,800	6,100	
	Btu/h	15,400	19,100	24,200	
Heating Capacity	kW	5.0	6.3	8.0	
	kcal/h	4,300	5,400	6,900	
	Btu/h	17,100	21,500	27,300	
Casing		Galvanized Steel Plate	Galvanized Steel Plate	Galvanized Steel Plate	
Dimensions (W x H x D)	Body	900 x 190 x 460	900 x 190 x 460	1,100 x 190 x 460	
		35.4 x 7.5 x 18.2	35.4 x 7.5 x 18.2	43.3 x 7.5 x 18.2	
Coil	Rows x Columns x FPI	(2 x 6 x 18) x 2	(2 x 6 x 18) x 2	(2 x 6 x 18) x 2	
	Face Area	0.17	0.17	0.22	
Fan	Type	Sirocco Fan	Sirocco Fan	Sirocco Fan	
	Motor Output x Number	W x EA	19 x 1+5x 1	19 x 1+5x 1	
	Running Current	A	0.76	0.97	
	Air Flow Rate (H / M / L) (High Mode-Factory set)	CMM	12.5 / 10.0 / 8.5	15.0 / 12.5 / 10.0	20.0 / 16.0 / 12.0
		cfm	450 / 360 / 810	530 / 450 / 360	710 / 570 / 430
		External Static Pressure	mmAq (Pa)	1 (10)	1 (10)
	Air Flow Rate (H / M / L) (Standard Mode)	CMM	12.5 / 10.0 / 8.5	15.0 / 12.5 / 10.0	20.0 / 16.0 / 12.0
		cfm	450 / 360 / 810	530 / 450 / 360	710 / 570 / 430
		External Static Pressure	mmAq (Pa)	0 (0)	0 (0)
	Drive		Direct	Direct	Direct
Motor Type		BLDC	BLDC	BLDC	
Temperature Control		Microprocessor Thermostat for cooling and heating	Microprocessor Thermostat for cooling and heating	Microprocessor Thermostat for cooling and heating	
Sound Absorbing Thermal Insulation Material		Foamed polystyrene	Foamed polystyrene	Foamed polystyrene	
Air Filter		-	-	-	
Safety Filter		Fuse	Fuse	Fuse	
Pipe Connections	Liquid Side	mm (inch)	6.35 (1/4)	6.35 (1/4)	
	Gas Side	mm (inch)	12.7 (1/2)	12.7 (1/2)	
	Drain Pipe (Internal Dia.)	mm	25.0	25.0	
Net Weight	kg (lbs)	20 (44.1)	20 (44.1)	22 (48.5)	
Gross Weight	kg (lbs)	22.2 (49.0)	22.2 (49.0)	25.8 (56.9)	
Noise Level (Sound Pressure, H / M / L)	dB(A)	34 / 31 / 29	36 / 34 / 31	39 / 35 / 32	
Power Supply	Ø, V, Hz	1, 220 - 240, 50	1, 220 - 240, 50	1, 220 - 240, 50	
Refrigerant Control		EEV	EEV	EEV	
Power Cable	mm ²	CV2.5 x 3C	CV2.5 x 3C	CV2.5 x 3C	
communication Cable	mm ²	1.0 - 1.5 x 2C	1.0 - 1.5 x 2C	1.0 - 1.5 x 2C	

Note : 1. Capacities are based on the following conditions :

- Cooling : Indoor temp. 27°C(80.6°F) DB / 19°C(66.2°F) WB
Outdoor temp. 35°C(95°F) DB / 24°C(75.2°F) WB
- Heating : Indoor temp.Indoor 20°C(68°F) DB / 15°C(59°F) WB
Outdoor temp. 7°C(44.6°F) DB / 6°C(42.8°F) WB
- Piping Length : Interconnected Pipe Length = 7.5m
- Difference Limit of Elevation (Outdoor - Indoor Unit) is Zero.

2. Capacities are net capacities

3. Due to our policy of innovation some specifications may be changed without prior notification

4. To be added for more available Models

5. EEV : Electronic Expansion Valve

6. Noise Level is Standard Mode (for actual High Mode (factory set) condition,Noise level may exceed the standard level by 1.5dB(A)

HIGH SENSIBLE

ARNU07GM2A4 / ARNU09GM2A4 / ARNU12GM2A4 / ARNU15GM2A4
ARNU28GM2A4 / ARNU36GM2A4 / ARNU42GM2A4



Model	Unit	ARNU07GM2A4	ARNU09GM2A4	ARNU12GM2A4	ARNU15GM2A4	ARNU28GM2A4	ARNU36GM2A4	ARNU42GM2A4	
Cooling Capacity	kW	2.2	2.8	3.6	4.5	8.2	10.6	12.3	
Heating Capacity	kW	2.5	3.2	4.0	5.0	9.2	11.9	13.8	
Power Input	Nominal W	30	30	30	30	123	184	231	
Dimensions (W x H x D)	Body	mm	1,250 x 270 x 700	1,250 x 270 x 700	1,250 x 270 x 700	1,250 x 270 x 700	1,250 x 270 x 700	1,250 x 270 x 700	
	Type		Sirocco Fan	Sirocco Fan	Sirocco Fan	Sirocco Fan	Sirocco Fan	Sirocco Fan	
	Motor Output x Number	W	350 x 1	350 x 1	350 x 1	350 x 1	350 x 1	350 x 1	
Fan	Air Flow Rate (H / M / L) (High Mode-Factory Set)	CMM	12.8 / 7.7 / 7.7	12.8 / 7.7 / 7.7	13.6 / 8.7 / 8.7	13.6 / 8.7 / 8.7	28.0 / 24.0 / 21.0	32.0 / 28.0 / 24.0	38.0 / 33.0 / 28.0
	External Static Pressure	mmAq (Pa)	452 / 272 / 272	452 / 272 / 272	480 / 307 / 307	480 / 307 / 307	989 / 848 / 742	1,130 / 989 / 848	1,342 / 1,165 / 989
		cmAq (Pa)	6 (59)	6 (59)	6 (59)	6 (59)	6 (59)	6 (59)	6 (59)
Fan	Air Flow Rate (H / M / L) (Standard Mode)	CM	12.8 / 7.7 / 7.7	12.8 / 7.7 / 7.7	13.6 / 8.7 / 8.7	13.6 / 8.7 / 8.7	28.0 / 24.0 / 21.0	32.0 / 28.0 / 24.0	38.0 / 33.0 / 28.0
	External Static Pressure	cmAq (Pa)	452 / 272 / 272	452 / 272 / 272	480 / 307 / 307	480 / 307 / 307	989 / 848 / 742	1,130 / 989 / 848	1,342 / 1,165 / 989
		mmAq (Pa)	5 (49)	5 (49)	5 (49)	5 (49)	5 (49)	5 (49)	5 (49)
	Motor Type		BLDC	BLDC	BLDC	BLDC	BLDC	BLDC	
Air Filter		-	-	-	-	-	-	-	
Safety Device		Fuse	Fuse	Fuse	Fuse	Fuse	Fuse	Fuse	
Pipe Connections	Liquid Side	mm (inch)	Ø9.52 (3/8)	Ø9.52 (3/8)	Ø9.52 (3/8)	Ø9.52 (3/8)	Ø9.52 (3/8)	Ø9.52 (3/8)	
	Gas Side	mm (inch)	Ø15.88 (5/8)	Ø15.88 (5/8)	Ø15.88 (5/8)	Ø15.88 (5/8)	Ø15.88 (5/8)	Ø15.88 (5/8)	
	Drain Pipe (Internal Dia.)	mm (inch)	25 (1)	25 (1)	25 (1)	25 (1)	25 (1)	25 (1)	
Net Weight	Body	kg (lbs)	38.0 (84)	38.0 (84)	38.0 (84)	38.0 (84)	38.0 (84)	39.5 (87)	
Sound Pressure Levels (H / M / L)		dB(A)	38 / 36 / 36	38 / 36 / 36	38 / 36 / 36	38 / 36 / 36	36 / 34 / 33	37 / 36 / 34	38 / 37 / 36
Sound Power Levels (H / M / L)		dB(A)	54 / 53 / 53	54 / 53 / 53	53 / 52 / 52	53 / 52 / 52	59 / 57 / 55	60 / 59 / 57	62 / 61 / 60
Power Supply		Ø, V, Hz	1, 220 - 240, 50	1, 220 - 240, 50	1, 220 - 240, 50	1, 220 - 240, 50	1, 220 - 240, 50	1, 220 - 240, 50	
			1, 220, 60	1, 220, 60	1, 220, 60	1, 220, 60	1, 220, 60	1, 220, 60	
Transmission Cable			1.0 - 1.5 x 2C	1.0 - 1.5 x 2C	1.0 - 1.5 x 2C	1.0 - 1.5 x 2C	1.0 - 1.5 x 2C	1.0 - 1.5 x 2C	

※ Nominal : Performance tested under EN14511

※ Rated : Max. power input allowed for fan motor

Note : 1. Capacities are based on the following conditions

- Cooling : Indoor temp. 27°C (80.6°F) DB / 19°C (66.2°F) WB, Outdoor temp. 35°C (95°F) DB / 24°C (75.2°F) WB, Interconnecting piping length 7.5m, Level difference of zero

- Heating : Indoor temp. 20°C (68°F) DB / 15°C (59°F) WB, Outdoor temp. 7°C (44.6°F) DB / 6°C (42.8°F) WB, Interconnecting piping length 7.5m, Level difference of zero

2. Due to our policy of innovation some specifications may be changed without notification

3. I.D : 'Internal Diameter'

Accessories

Chassis	ARNU07GM2A4	ARNU09GM2A4	ARNU12GM2A4	ARNU15GM2A4	ARNU28GM2A4	ARNU36GM2A4	ARNU42GM2A4
Drain Pump				○			
Cassette Cover				-			
Refrigerant Leakage Detector				PRLDNV50			
EEV Kit				-			
Independent Power Module				PRIP0			
Robot Cleaner				-			
Pre Filter (Washable / Anti-fungus)				○			
Ion Generator				-			
CO ₂ Sensor				-			
Ventilation Kit				-			
IR Receiver				PWLRVN000			
Zone Controller				ABZCA			
Dry Contact (with Additional Accessory)				PDRYCB000 (1 point contact) PDRYCB300 (8 points for thermostat compatible) NEW PDRYCB320 (Universal input) ¹⁾ PDRYCB400 (2 points input) PDRYCB500 (Modbus)			
External Input (1 point)				○			
Wi-Fi				PWFMD200			

※ ○ : Applied, - : Not applied

Option : Refer to model name in table

1) Available from April 2020

ARNU18GM3A4 / ARNU24GM3A4 / ARNU28GM3A4



Model	Unit	ARNU18GM3A4	ARNU24GM3A4	ARNU28GM3A4
Cooling Capacity	kW	5.6	7.1	8.2
Heating Capacity	kW	6.3	8.0	9.2
Power Input	Nominal W	50	75	75
Dimensions (W x H x D)	Body	mm	Galvanized Steel Plate	Galvanized Steel Plate
	Type		1,250 x 360 x 700	1,250 x 360 x 700
	Motor Output x Number	W	Sirocco Fan	Sirocco Fan
Fan	Air Flow Rate (H / M / L) (High Mode-Factory Set)	CMM	350 x 1	350 x 1
	External Static Pressure	cmAq (Pa)	32.7 / 26.7 / 23.0	35.5 / 30.6 / 26.2
		mmAq (Pa)	1,155 / 943 / 812	1,254 / 1,081 / 925
Fan	Air Flow Rate (H / M / L) (Standard Mode)	CM	6 (59)	6 (59)
	External Static Pressure	cmAq (Pa)	32.7 / 26.7 / 23.0	35.5 / 30.6 / 26.2
		mmAq (Pa)	1,155 / 943 / 812	1,254 / 1,081 / 925
	Motor Type		5 (49)	5 (49)
Air Filter		BLDC	BLDC	BLDC
Safety Device		-	-	-
Pipe Connections	Liquid Side	mm (inch)	Ø9.52 (3/8)	Ø9.52 (3/8)
	Gas Side	mm (inch)	Ø15.88 (5/8)	Ø15.88 (5/8)
	Drain Pipe (Internal Dia.)	mm (inch)	25 (1)	25 (1)
Net Weight	Body	kg (lbs)	44 (97)	44 (97)
Sound Pressure Levels (H / M / L)		dB(A)	39 / 37 / 36	40 / 38 / 37
Sound Power Levels (H / M / L)		dB(A)	53 / 52 / 51	54 / 53 / 52
Power Supply		Ø, V, Hz	1, 220 - 240, 50	1, 220 - 240, 50
			1, 220, 60	1, 220, 60
Transmission Cable			1.0 - 1.5 x 2C	1.0 - 1.5 x 2C

※ Nominal : Performance tested under EN14511

※ Rated : Max. power input allowed for fan motor

Note : 1. Capacities are based on the following conditions

- Cooling : Indoor temp. 27°C (80.6°F) DB / 19°C (66.2°F) WB, Outdoor temp. 35°C (95°F) DB / 24°C (75.2°F) WB, Interconnecting piping length 7.5m, Level difference of zero

- Heating : Indoor temp. 20°C (68°F) DB / 15°C (59°F) WB, Outdoor temp. 7°C (44.6°F) DB / 6°C (42.8°F) WB, Interconnecting piping length 7.5m, Level difference of zero

2. Due to our policy of innovation some specifications may be changed without notification

3. I.D : 'Internal Diameter'

Accessories

Chassis	ARNU18GM3A4	ARNU24GM3A4	ARNU28GM3A4
Drain Pump			○
Cassette Cover			-
Refrigerant Leakage Detector			PRLDNV50
EEV Kit			-
Independent Power Module			PRIP0
Robot Cleaner			-
Pre Filter (Washable / Anti-fungus)			○
Ion Generator			-
CO ₂ Sensor			-
Ventilation Kit			-
IR Receiver			PWLRVN000
Zone Controller			ABZCA
Dry Contact (with Additional Accessory)			PDRYCB000 (1 point contact) PDRYCB300 (8 points for thermostat compatible) NEW PDRYCB320 (Universal input) ¹⁾ PDRYCB400 (2 points input) PDRYCB500 (Modbus)
External Input (1 point)			○
Wi-Fi			PWFMD200

※ ○ : Applied, - : Not applied

Option : Refer to model name in table

1) Available from April 2020

FRESH AIR INTAKE UNIT

Fresh Outdoor Air Supply

The LG Fresh Air Intake Unit (FAU) is the alternative solution for ventilation, which supplies the fresh outdoor air indoors as well as being able to cool and heat air inside simultaneously. It means the indoor space can have positive air pressure consistently, which can block cold, hot or contaminated air from Outdoor.

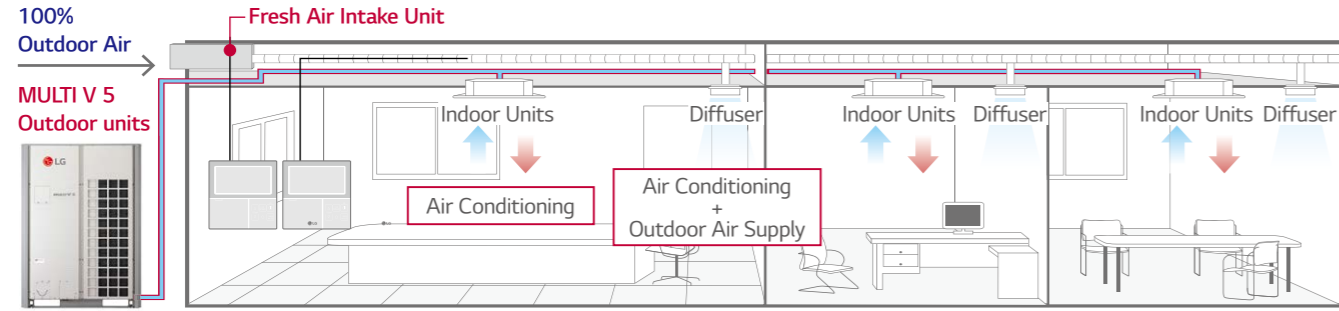

Economic Operation

Using the cooling and heating can save costs by blowing the natural outdoor air inside when the season change.

Spring Season

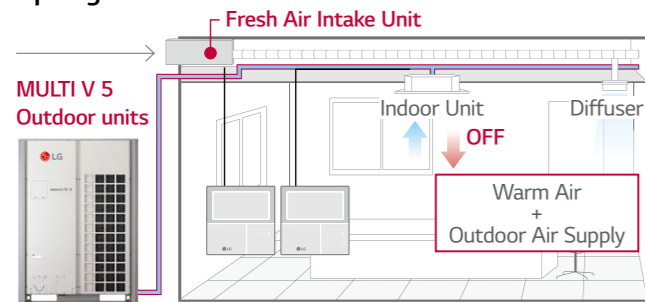

Autumn Season

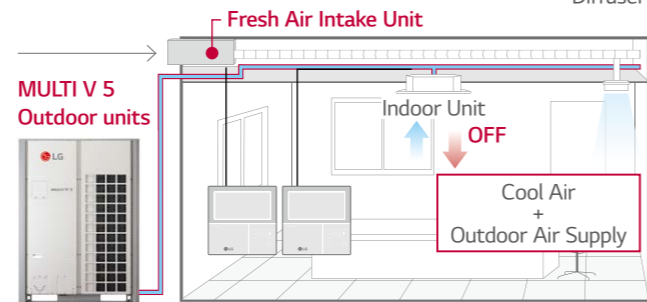

Installation Scene

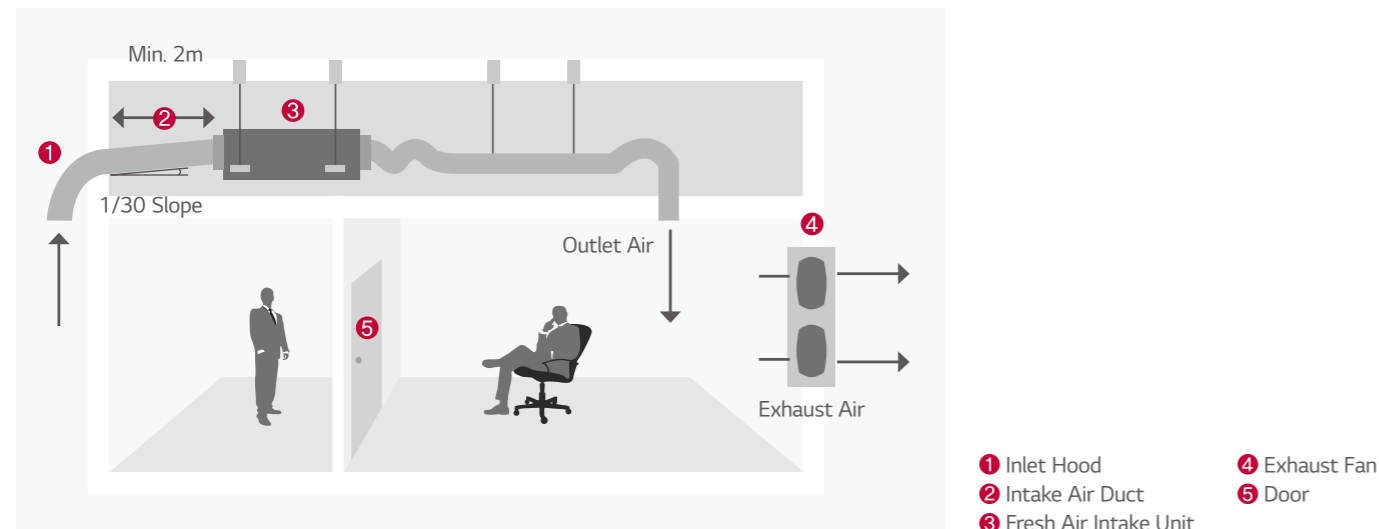

FRESH AIR INTAKE UNIT

ARNU76GB8Z4 / ARNU96GB8Z4



Model	Unit	ARNU76GB8Z4	ARNU96GB8Z4
Cooling Capacity	kW	22.4	28.0
Heating Capacity	kW	21.4	26.7
Power Input (H / M / L)	Nominal W	230 / 200 / 200	360 / 230 / 230
Dimensions (W x H x D)	Body	mm 1,562 x 460 x 688	1,562 x 460 x 688
	Shipping	mm 1,806 x 537 x 825	1,806 x 537 x 825
Fan	Type	Sirocco Fan	Sirocco Fan
	Motor Output x Number	W x No. 375 x 1	375 x 1
	Air Flow Rate (H / M / L) (High Mode-Factory Set)	m ³ /min 23.7 / 13.2 / 13.2	35.7 / 23.7 / 23.7
	External Static Pressure	mmAq (Pa) 22 (216)	22 (216)
	Motor Type	BLDC	BLDC
Air Filter		Long Life Filter	Long Life Filter
Pipe Connections	Liquid Side	mm (inch) Ø9.52 (3/8)	Ø9.52 (3/8)
	Gas Side	mm (inch) Ø19.05 (3/4)	Ø22.2 (7/8)
	Drain Pipe (Internal Dia.)	mm (inch) Ø25 (1)	Ø25 (1)
Weight	Body	kg 73.0	73.0
	Sound Pressure Levels (H / M / L)	dB(A) 45 / 43 / 43	47 / 45 / 45
Sound Power Levels (H / M / L)		70 / 67 / 67	72 / 70 / 70
	Power Supply	∅, V, Hz 1, 220 - 240, 50	1, 220 - 240, 50
Communication Cable		1, 220, 60	1, 220, 60
		mm ² x No. 1.0 - 1.5 x 2C	1.0 - 1.5 x 2C

※ Nominal : Performance tested under EN14511
 ※ Rated : Max. power input allowed for fan motor
 Note : 1. Capacities are based on the following conditions
 - Cooling : Outdoor temp. 35°C (95°F) DB / 24°C (75.2°F) WB, Interconnecting piping length 7.5m, Level difference of zero
 - Heating : Outdoor temp. 7°C (44.6°F) DB / 6°C (42.8°F) WB, Interconnecting piping length 7.5m, Level difference of zero
 2. Capacities are net capacities
 3. Noise Level is under standard mode [For actual High Mode (Factory set) condition, Noise Level may exceed the standard level by 1.5dB(A)]
 4. Due to our policy of innovation some specifications may be changed without prior notification.
 5. I.D : 'Internal Diameter'

CAUTION

1. Operation range (Cooling : 5°C - 43°C, Heating : -5°C - 43°C)
2. Installation of exhaust fan is recommended for a sealed room.
3. Indoor Unit Connection

No	Connection Condition	Combination
1	Fresh air intake units only are connected with outdoor units	1) The total capacity of fresh air intake unit should be 50 - 100% of outdoor unit. 2) The max quantity of fresh air intake is 4 units.
2	Mixture connection with general indoor unit and fresh intake units	1) The total capacity of indoor units (Standard Indoor Unit + Fresh Air Intake Unit) should be 50 - 100% of outdoor unit. 2) The total capacity of fresh air intake unit should be less than 30% of the total capacity of indoor units.

Accessories

Chassis	ARNU76GB8Z4	ARNU96GB8Z4
Drain Pump		○
Cassette Cover		-
Refrigerant Leakage Detector		PRLDNV50
EEV Kit		-
Independent Power Module		PRIP0
Robot Cleaner		-
Pre Filter (Washable / Anti-fungus)		○
Ion Generator		-
CO ₂ Sensor		-
Ventilation Kit		-
IR Receiver		PWLRVN000
Zone Controller		-
Dry Contact (with Additional Accessory)		PDRYCB000 (1 point contact) PDRYCB300 (8 points for thermostat compatible) PDRYCB400 (2 points input) PDRYCB500 (Modbus)
External Input (1 point)		○
Wi-Fi		PWFMD200

※ ○ : Applied, - : Not applied
 Option : Refer to model name in table

FLOOR STANDING UNIT



Features & Benefits

- The powerful air speed and volume means the air flow can reach up to 15m away from the air conditioner.

Key Applications

- Retail
- Shop
- Office
- Restaurant

Simple & Elegant Design

With its stylish design, LG's new floor standing air conditioner enhances the overall indoor interior.



Less Temperature Difference

Power cooling and heating will minimize the temperature difference between upper part and lower part of the room.

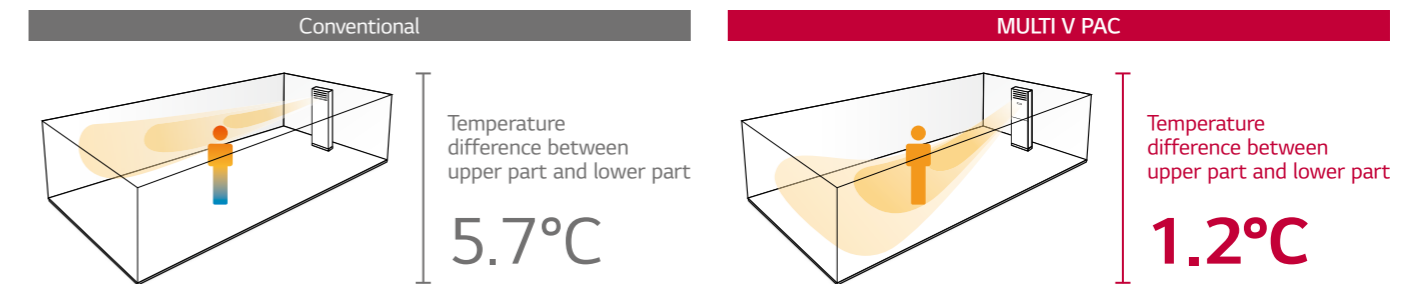

※ Temperature difference between upper part and lower part
 ※ Test Condition : Indoor temperature 12°C, Outdoor temperature 7°C, Setting Temperature 30°C
 ※ Measure Condition : After 3 hours heating operation (average temperature)

15m Long Power Cooling

The new LG floor standing unit is efficient for using in large areas due to its powerful cooling and heating operation. The powerful air speed and volume means the air flow can reach up to 15m away from the air conditioner.



※ Based on 131.8m²

Type	Floor Standing
Air Flow (m ³ /min)	37
Air Speed (m/s)	4.5

FLOOR STANDING UNIT

ARNU48GPTA4
ARNU96GPFA4



Model	Independent Unit			ARNU48GPTA4	ARNU96GPFA4
Capacity	Cooling	Nom	kW	14.1	28.0
	Heating	Nom	kW	15.9	31.5
Power Input	Cooling	Nom	w	250	400
	Heating	Nom	w	250	400
	Cooling	Rated	w	250	400
	Heating	Rated	w	250	400
Power Supply	Ø, V, Hz			1, 220, 60	1, 220, 60
Airflow Rate	Cooling	Power / H / M / L	m ³ /min	37 / 33 / 28 / 24	68 / 61 / - / 50
	Heating	Power / H / M / L	m ³ /min	37 / 33 / 28 / 24	68 / 61 / - / 50
Sound Pressure	Power / H / M / L			54 / 51 / 49 / 45	60 / 57 / - / 53
Dimension	Body	W x H x D	mm	590 x 1,840 x 440	1,050 x 1,880 x 495
Net Weight				48.0	113.0
Piping Connection	Liquid			9.52	9.52
	Gas			15.88	22.2
	Drain	I.D	mm	-	-

※ This product contains Fluorinated Greenhouse Gases. (R410A)

※ Nom. : Performance tested under EN14511

※ Rated : Max power input allowed for fan motor

Note : 1. Capacities are based on the following conditions

- Cooling : Indoor temp. 27°C (80.6°F) DB / 19°C (66.2°F) WB, Outdoor temp. 35°C (95°F) DB / 24°C (75.2°F) WB, Interconnecting piping length 7.5m, Level difference of zero
- Heating : Indoor temp. 20°C (68°F) DB / 15°C (59°F) WB, Outdoor temp. 7°C (44.6°F) DB / 6°C (42.8°F) WB, Interconnecting piping length 7.5m, Level difference of zero

2. Due to our policy of innovation some specifications may be changed without notification

3. I.D : 'Internal Diameter'

Accessories

Model	ARNU07GCE*4	ARNU09GCE*4
Dry Contact	Simple (1 Contact Point with Case)	PDRYCB000
	2 Contact Point	PDRYCB400
	For Thermostat (On-Off / Mode / Fan Speed)	PDRYCB300 / NEW PDRYCB320
	Modbus Communication	PDRYCB500
EEV Kit for MULTI V Indoor	-	
IR Receiver	PWLRVN000	

Wired Remote Controller							Wireless Remote Controller
Premium	Standard III		Standard II		Simple	Simple for Hotel	
PREMTA000 PREMTA000A PREMTA000B	PREMTB100 (White)	PREMTB10 (Black)	PREMTB001 (White)	PREMTB01 (Black)	PQRCVCL0Q (Black) PQRCVCL0QW (White)	PQRCHCA0Q (Black) PQRCHCA0QW (White)	PQWRHQ0FDB

CEILING SUSPENDED UNIT



Features & Benefits

- The powerful air speed and volume means the air flow can reach up to 15m away from the air conditioner.

Key Applications

- Retail
- Shop
- Office
- Restaurant

Differentiated Design

With its stunning V-shaped design and black vane, LG's new ceiling-suspended air conditioner exudes modern elegance appropriate for any space. The tasteful aesthetics of the air conditioner helped earn it the iF Design Award.



Powerful Cooling & Heating

High ceiling mode provides powerful cooling and heating up to 4.2m in height, from ceiling to floor.



One Touch & 2 Piece Filter

Easy in / out filter structure as well as a simplified two-piece filter, which slides out for easy cleaning and maintenance.

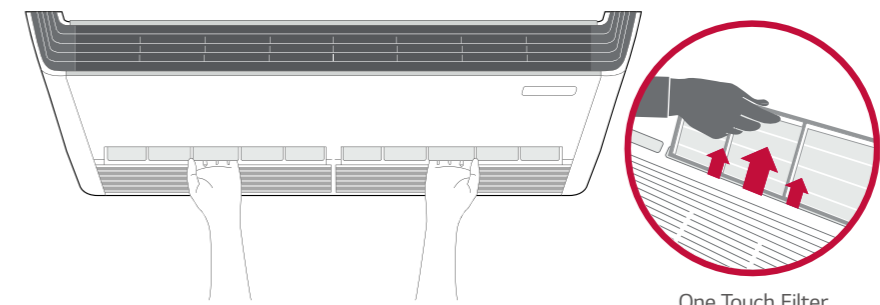

One Touch Filter

CEILING SUSPENDED UNIT

Two Thermistors Control

Users can purchase a wired remote controller that includes a second thermistor, allowing for temperature checks from multiple locations.

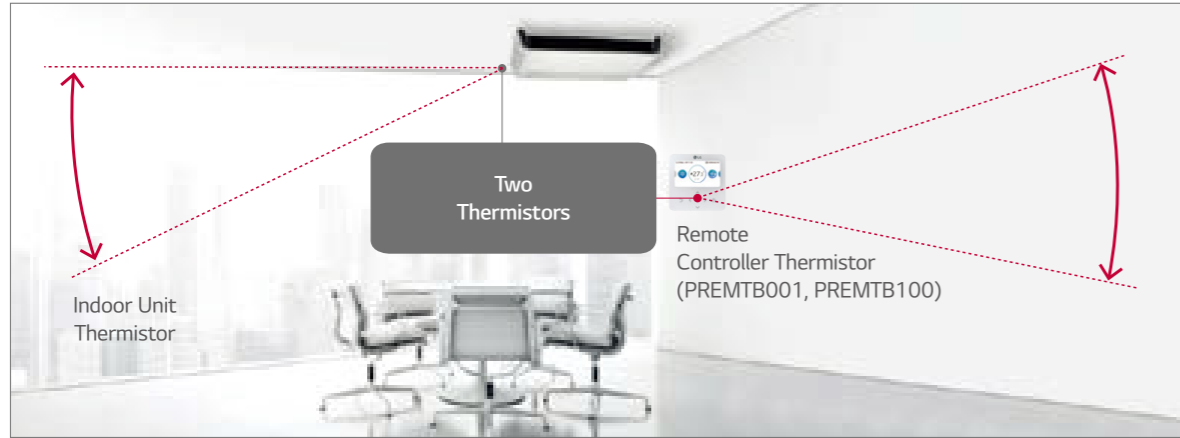

Wi-Fi Control

Control your air conditioners via using the smart internet devices as Android or iOS based smartphones. This advanced technology provides you the best convenience.

LG ThinQ

 Search "LG ThinQ" on Google market or Appstore then download the app.

Access your air conditioner anytime and from anywhere

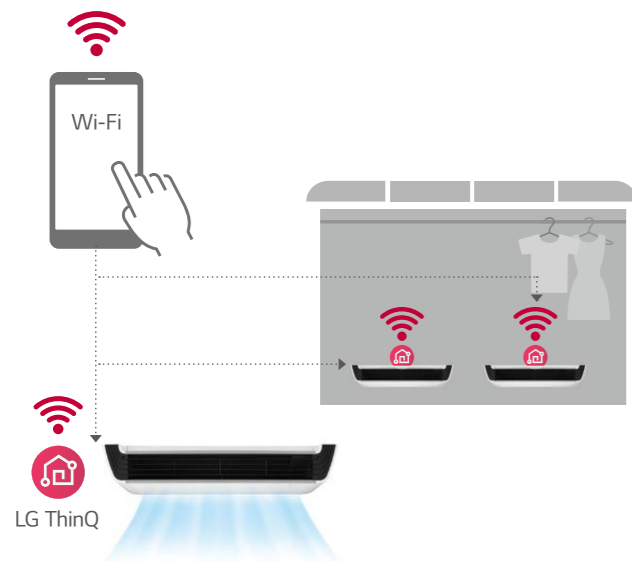

Easy Registration and Log-in

Follow the easy set-up steps that will activate LG ThinQ's impressive feature.

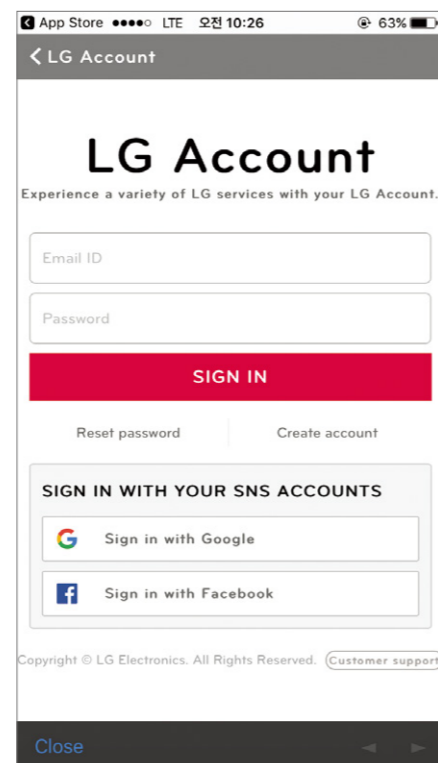

CEILING SUSPENDED UNIT

ARNU18GV1A4 / ARNU24GV1A4
ARNU36GV2A4 / ARNU48GV2A4



Model	Unit	ARNU18GV1A4	ARNU24GV1A4	ARNU36GV2A4	ARNU48GV2A4
Cooling Capacity	kW	5.6	7.1	10.6	14.1
Heating Capacity	kW	6.3	8.0	11.9	15.9
Power Input (H / M / L)	Nominal W	23 / 20 / 17	25 / 21 / 17	84 / 77 / 66	91 / 79 / 66
Exterior Color		Morning Fog	Morning Fog	Morning Fog	Morning Fog
RAL code		RAL 9001	RAL 9001	RAL 9001	RAL 9001
Dimensions (W x H x D)	Body	mm	1,200 x 235 x 690	1,200 x 235 x 690	1,600 x 235 x 690
	Shipping	mm	1,315 x 320 x 772	1,315 x 320 x 772	1,715 x 320 x 772
Fan	Type		Cross Flow Fan	Cross Flow Fan	Cross Flow Fan
	Motor Output x Number	W x No.	85.9 x 1	85.9 x 1	125 x 1
	Air Flow Rate (H / M / L)	m ³ /min	13.5 / 12.5 / 12.0	14.0 / 13.0 / 12.0	27.0 / 24.0 / 20.0
	Motor Type		BLDC	BLDC	BLDC
Air Filter		Pre Filter	Pre Filter	Pre Filter	Pre Filter
Pipe Connections	Liquid Side	mm (inch)	Ø6.35 (1/4)	Ø9.52 (3/8)	Ø9.52 (3/8)
	Gas Side	mm (inch)	Ø12.7 (1/2)	Ø15.88 (5/8)	Ø15.88 (5/8)
	Drain Pipe (Internal Dia.)	mm (inch)	Ø16 (5/8)	Ø16 (5/8)	Ø16 (5/8)
Weight	Body kg	29.0	29.0	37.0	37.0
Sound Pressure Levels (H / M / L)	dB(A)	36 / 34 / 33	37 / 35 / 33	48 / 46 / 44	49 / 47 / 44
Sound Power Levels (H / M / L)	dB(A)	61 / 59 / 56	62 / 59 / 56	68 / 66 / 64	68 / 67 / 66
Power Supply	Ø, V, Hz	1, 220 - 240, 50	1, 220 - 240, 50	1, 220 - 240, 50	1, 220 - 240, 50
		1, 220, 60	1, 220, 60	1, 220, 60	1, 220, 60
Communication Cable	mm ² x No.	1.0 - 1.5 x 2C	1.0 - 1.5 x 2C	1.0 - 1.5 x 2C	1.0 - 1.5 x 2C

※ Nominal : Performance tested under EN14511
 ※ Rated : Max. power input allowed for fan motor
 Note : 1. Capacities are based on the following conditions
 - Cooling : Indoor temp. 27°C (80.6°F) DB / 19°C (66.2°F) WB, Outdoor temp. 35°C (95°F) DB / 24°C (75.2°F) WB, Interconnecting piping length 7.5m, Level difference of zero
 - Heating : Indoor temp. 20°C (68°F) DB / 15°C (59°F) WB, Outdoor temp. 7°C (44.6°F) DB / 6°C (42.8°F) WB, Interconnecting piping length 7.5m, Level difference of zero
 2. Due to our policy of innovation some specifications may be changed without notification
 3. I.D : 'Internal Diameter'

Accessories

Chassis	ARNU18GV1A4	ARNU24GV1A4	ARNU36GV2A4	ARNU48GV2A4
Drain Pump			-	
Cassette Cover			-	
Refrigerant Leakage Detector			PRLDNVSO	
EEV Kit			-	
Independent Power Module			PRIPO	
Robot Cleaner			-	
Pre Filter (Washable / Anti-fungus)			○	
Ion Generator			-	
CO ₂ Sensor			-	
Ventilation Kit			-	
IR Receiver			-	
Zone Controller			-	
Dry Contact (with Additional Accessory)			PDRYCB000 (1 point contact) PDRYCB300 (8 points for thermostat compatible) NEW PDRYCB320 (Universal input) ¹⁾ PDRYCB400 (2 points input) PDRYCB500 (Modbus)	
External Input (1 point)			○	
Wi-Fi			PWFMDD200	

※ ○ : Applied, - : Not applied
 Option : Refer to model name in table
 1) Available from April 2020

CEILING & FLOOR CONVERTIBLE UNIT

ARNU09GVEA4 / ARNU12GVEA4



Model	Unit	ARNU09GVEA4	ARNU12GVEA4
Cooling Capacity	kW	2.8	3.6
Heating Capacity	kW	3.2	4.0
Power Input (H / M / L)	Nominal W	19 / 15 / 11	28 / 19 / 15
Exterior Color		Morning Fog	Morning Fog
RAL code		RAL 9001	RAL 9001
Dimensions (W x H x D)	Body	mm	900 x 490 x 200
	Shipping	mm	975 x 279 x 562
Fan	Type		Cross Flow Fan
	Motor Output x Number	W x No.	27 x 1
	Air Flow Rate (H / M / L)	m ³ /min cfm	7.6 / 6.9 / 6.2 268 / 244 / 219
	Motor Type		BLDC
Air Filter		Pre Filter	Pre Filter
Pipe Connections	Liquid Side	mm (inch)	Ø6.35 (1/4)
	Gas Side	mm (inch)	Ø12.7 (1/2)
	Drain Pipe (Internal Dia.)	mm (inch)	Ø16 (5/8)
Weight	Body kg	13.3	13.3
Sound Pressure Levels (H / M / L)	dB(A)	36 / 32 / 28	38 / 36 / 30
Sound Power Levels (H / M / L)	dB(A)	55 / 51 / 45	56 / 55 / 49
Power Supply	Ø, V, Hz	1, 220 - 240, 50	1, 220 - 240, 50
		1, 220, 60	1, 220, 60
Communication Cable	mm ² x No.	1.0 - 1.5 x 2C	1.0 - 1.5 x 2C

※ Nominal : Performance tested under EN14511
 ※ Rated : Max. power input allowed for fan motor
 Note : 1. Capacities are based on the following conditions
 - Cooling : Indoor temp. 27°C (80.6°F) DB / 19°C (66.2°F) WB, Outdoor temp. 35°C (95°F) DB / 24°C (75.2°F) WB, Interconnecting piping length 7.5m, Level difference of zero
 - Heating : Indoor temp. 20°C (68°F) DB / 15°C (59°F) WB, Outdoor temp. 7°C (44.6°F) DB / 6°C (42.8°F) WB, Interconnecting piping length 7.5m, Level difference of zero
 2. Due to our policy of innovation some specifications may be changed without notification
 3. I.D : 'Internal Diameter'

Accessories

Chassis	ARNU09GVEA4	ARNU12GVEA4
Drain Pump		-
Cassette Cover		-
Refrigerant Leakage Detector		PRLDNVSO
EEV Kit		PRGK024A0
Independent Power Module		PRIPO
Robot Cleaner		-
Pre Filter (Washable / Anti-fungus)		○
Ion Generator		-
CO ₂ Sensor		-
Ventilation Kit		-
IR Receiver		-
Zone Controller		-
Dry Contact (with Additional Accessory)		PDRYCB000 (1 point contact) PDRYCB300 (8 points for thermostat compatible) NEW PDRYCB320 (Universal input) ¹⁾ PDRYCB400 (2 points input) PDRYCB500 (Modbus)
External Input (1 point)		○
Wi-Fi		PWFMDD200 ¹⁾

※ ○ : Applied, - : Not applied
 Option : Refer to model name in table
 1) Available from April 2020

CONSOLE & FLOOR STANDING UNIT



Features & Benefits

- Ideal for Installation Beneath a Window
- Unit Requires Minimal Installation Space
- Fitted with a Washable Long-life Filter

Key Applications

- School
- Office
- Church
- Historic Building

	Floor standing	Console	Floor Standing Unit
Smart	Wi-Fi	○	○
Energy Efficiency	Jet Cool	-	○
Health	Ionizer	○	-
Fast Cooling & Heating	Jet Cool	○	-
Comfort	Sleep Mode	○	○
	Timer (On / Off)	○	○
	Timer (Weekly)	○	○
	Two Thermistor Control	○	○
	Group Control	○	○

※ ○ : Applied, - : Not applied

Installation Support Clip

During the cooling operation, the vane adjusts upwards to direct the air flow towards the ceiling. When heating, the vane directs the warm air downwards to balance the room temperature especially for floor.

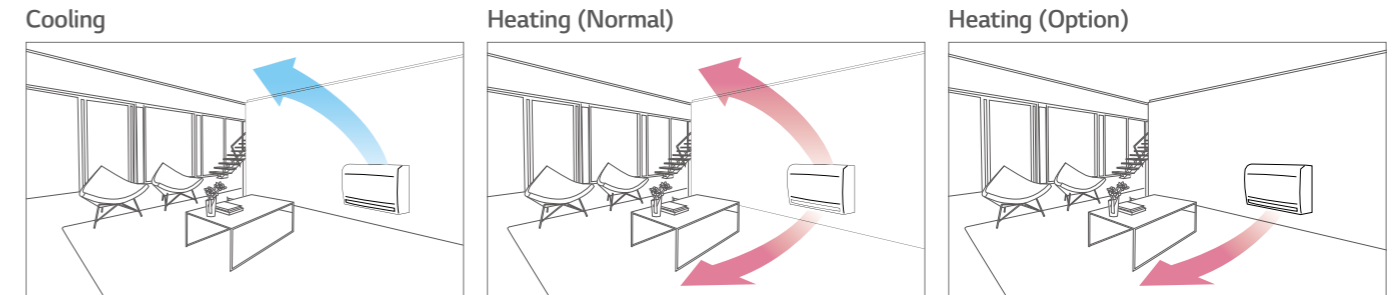

Block Cold Draft

The console can block cold drafts from windows to provide a warmer environment for places such as libraries and offices.

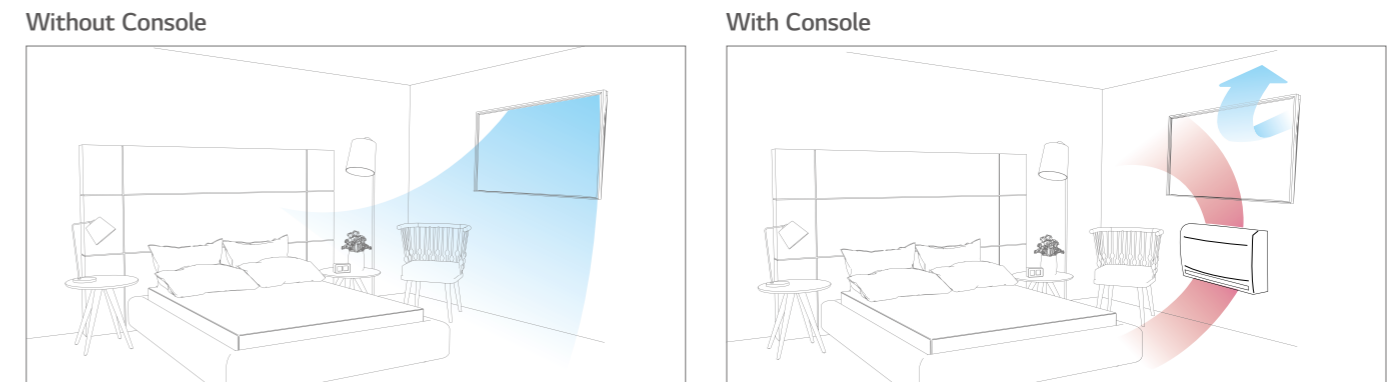

5-Step Vane Control

There are 5 different stages to control air flow direction.

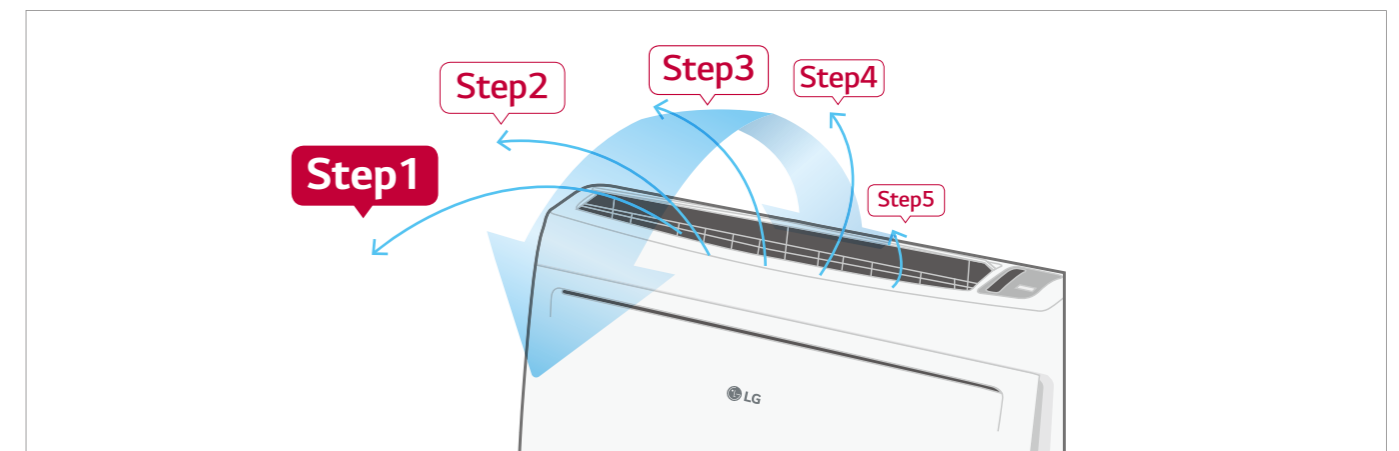

CONSOLE & FLOOR STANDING UNIT

3 Way Flexible Installation

It is possible to install and connect the outdoor unit in 6 different ways. (Right side, Right back, Right floor, Left side, Left back, Left floor)



Block Cold Draft

The floor standing unit can block cold drafts from windows to provide a warmer environment for places such as libraries and offices.

Without Floor Standing

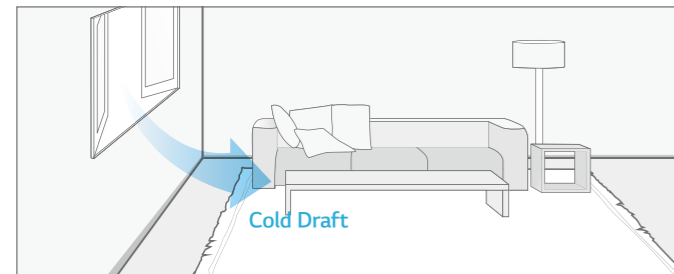

With Floor Standing

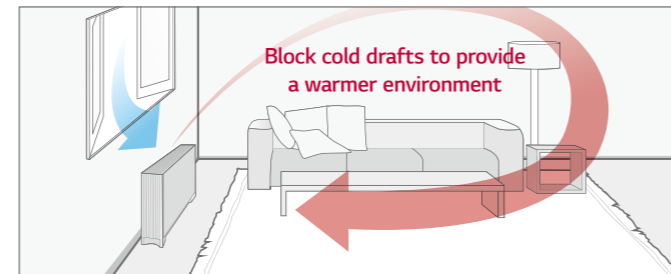

3 Way Flexible Installation

It is possible to install and connect the outdoor unit in 3 different ways (Side, Back, Floor).

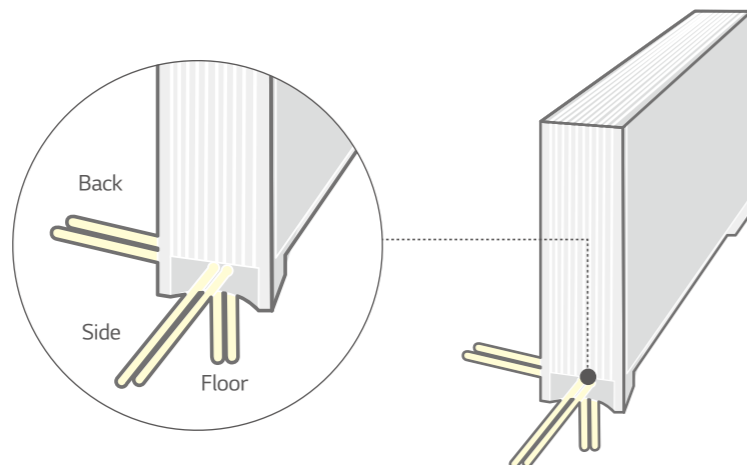

Sliding Type Filter

Easy maintenance and extended product life with sliding type filter.

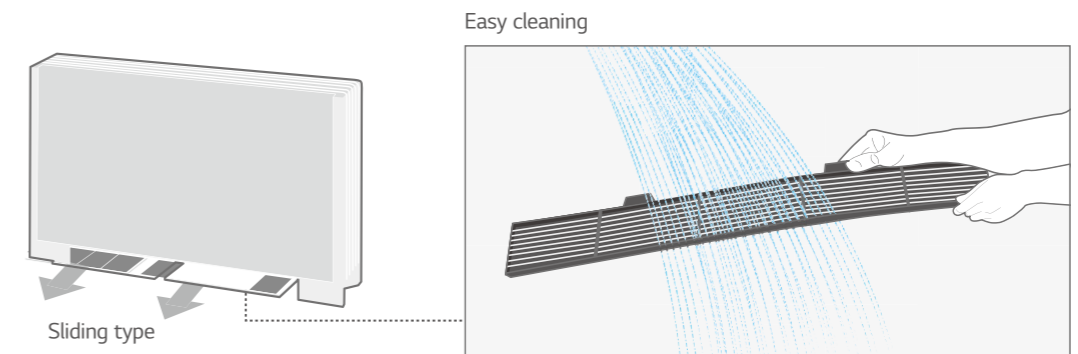

Wi-Fi Control

Control your air conditioners via using the smart internet devices as Android or iOS based smartphones. This advanced technology provides you the best convenience.

LG ThinQ

Search "LG ThinQ" on Google market or Appstore then download the app.

Access your air conditioner anytime and from anywhere

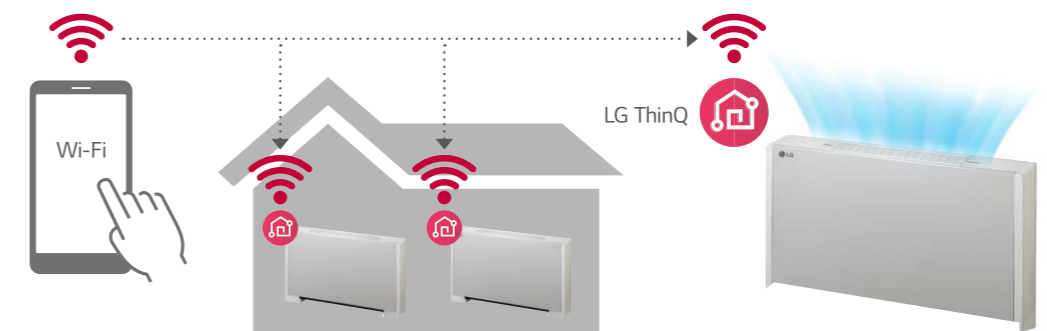

CONSOLE

ARNU07GQAA4 / ARNU09GQAA4



Model	Unit	ARNU07GQAA4	ARNU09GQAA4
Cooling Capacity	kW	2.2	2.8
Heating Capacity	kW	2.5	3.2
Power Input (H / M / L)	Nominal W	15 / 12 / 10	15 / 12 / 10
Exterior Color		Morning Fog	Morning Fog
RAL Code		RAL 9001	RAL 9001
Dimensions (W x H x D)	Body	700 x 600 x 210	700 x 600 x 210
	Shipping	775 x 662 x 284	775 x 662 x 284
Fan	Type	Turbo fan	Turbo fan
	Motor Output x Number	W x No.	48 x 1
	Air Flow Rate (H / M / L)	m ³ /min	6.7 / 5.9 / 4.8
	Motor Type	BLDC	BLDC
Air Filter		Pre Filter	Pre Filter
Pipe Connections	Liquid Side	mm (inch)	Ø6.35(1/4)
	Gas Side	mm (inch)	Ø12.7(1/2)
	Drain Pipe (Internal Dia.)	mm (inch)	Ø12(15/32)
Weight	Body	kg	14.0
Sound Pressure Levels (H / M / L)		dB(A)	37 / 34 / 28
Sound Power Levels (H / M / L)		dB(A)	53 / 50 / 44
Power Supply	Ø, V, Hz		1, 220 - 240, 50 1, 220, 60
Communication Cable	mm ² x No.		1.0 - 1.5 x 2C 1.0 - 1.5 x 2C

※ Nominal : Performance tested under EN14511

※ Rated : Max. power input allowed for fan motor

Note : 1. Capacities are based on the following conditions

- Cooling : Indoor temp. 27°C (80.6°F) DB / 19°C (66.2°F) WB, Outdoor temp. 35°C (95°F) DB / 24°C (75.2°F) WB, Interconnecting piping length 7.5m, Level difference of zero

- Heating : Indoor temp. 20°C (68°F) DB / 15°C (59°F) WB, Outdoor temp. 7°C (44.6°F) DB / 6°C (42.8°F) WB, Interconnecting piping length 7.5m, Level difference of zero

2. Due to our policy of innovation some specifications may be changed without notification

3. I.D : 'Internal Diameter'

ARNU12GQAA4 / ARNU15GQAA4



Model	Unit	ARNU12GQAA4	ARNU15GQAA4
Cooling Capacity	kW	3.6	4.5
Heating Capacity	kW	4.0	5.0
Power Input (H / M / L)	Nominal W	18 / 15 / 13	24 / 19 / 17
Exterior Color		Morning Fog	Morning Fog
RAL Code		RAL 9001	RAL 9001
Dimensions (W x H x D)	Body	700 x 600 x 210	700 x 600 x 210
	Shipping	775 x 662 x 284	775 x 662 x 284
Fan	Type	Turbo fan	Turbo fan
	Motor Output x Number	W x No.	48 x 1
	Air Flow Rate (H / M / L)	m ³ /min	7.5 / 5.9 / 4.8
	Motor Type	BLDC	BLDC
Air Filter		Pre Filter	Pre Filter
Pipe Connections	Liquid Side	mm (inch)	Ø6.35 (1/4)
	Gas Side	mm (inch)	Ø12.7 (1/2)
	Drain Pipe (Internal Dia.)	mm (inch)	Ø12 (15/32)
Weight	Body	kg	14.0
Sound Pressure Levels (H / M / L)		dB(A)	39 / 34 / 28
Sound Power Levels (H / M / L)		dB(A)	56 / 50 / 44
Power Supply	Ø, V, Hz		1, 220 - 240, 50 1, 220, 60
Communication Cable	mm ² x No.		1.0 - 1.5 x 2C 1.0 - 1.5 x 2C

※ Nominal : Performance tested under EN14511

※ Rated : Max. power input allowed for fan motor

Note : 1. Capacities are based on the following conditions

- Cooling : Indoor temp. 27°C (80.6°F) DB / 19°C (66.2°F) WB, Outdoor temp. 35°C (95°F) DB / 24°C (75.2°F) WB, Interconnecting piping length 7.5m, Level difference of zero

- Heating : Indoor temp. 20°C (68°F) DB / 15°C (59°F) WB, Outdoor temp. 7°C (44.6°F) DB / 6°C (42.8°F) WB, Interconnecting piping length 7.5m, Level difference of zero

2. Due to our policy of innovation some specifications may be changed without notification

3. I.D : 'Internal Diameter'

Accessories

Chassis	ARNU07GQAA4	ARNU15GQAA4
Drain Pump		-
Cassette Cover		-
Refrigerant Leakage Detector		PRLDNVSO
EEV Kit		PRGK024A0
Independent Power Module		PRIPO
Robot Cleaner		-
Pre Filter (Washable / Anti-fungus)		○
Ion Generator		○
CO ₂ Sensor		-
Ventilation Kit		-
IR Receiver		-
Zone Controller		-
Dry Contact (with Additional Accessory)		PDRYCB000 (1 point contact) PDRYCB300 (8 points for thermostat compatible) NEW PDRYCB320 (Universal input) ¹⁾ PDRYCB400 (2 points input) PDRYCB500 (Modbus)
External Input (1 point)		○
Wi-Fi		PWFMD200

※ ○ : Applied, - : Not applied

Option : Refer to model name in table

1) Available from April 2020

Accessories

Chassis	ARNU12GQAA4	ARNU15GQAA4
Drain Pump		-
Cassette Cover		-
Refrigerant Leakage Detector		PRLDNVSO
EEV Kit		PRGK024A0
Independent Power Module		PRIPO
Robot Cleaner		-
Pre Filter (Washable / Anti-fungus)		○
Ion Generator		○
CO ₂ Sensor		-
Ventilation Kit		-
IR Receiver		-
Zone Controller		-
Dry Contact (with Additional Accessory)		PDRYCB000 (1 point contact) PDRYCB300 (8 points for thermostat compatible) NEW PDRYCB320 (Universal input) ¹⁾ PDRYCB400 (2 points input) PDRYCB500 (Modbus)
External Input (1 point)		○
Wi-Fi		PWFMD200

※ ○ : Applied, - : Not applied

Option : Refer to model name in table

1) Available from April 2020

FLOOR STANDING UNIT

ARNU07GCEA4 / ARNU09GCEA4 / ARNU12GCEA4
ARNU15GCEA4 / ARNU18GCF4 / ARNU24GCF4



※ A : Floor Standing with case

Model	Unit	ARNU07GCEA4	ARNU09GCEA4	ARNU12GCEA4	ARNU15GCEA4	ARNU18GCF4	ARNU24GCF4
Cooling Capacity	kW	2.2	2.8	3.6	4.5	5.6	7.1
Heating Capacity	kW	2.5	3.2	4.0	5.0	6.3	8.0
Power Input (H / M / L)	Nominal W	24 / 17 / 14	30 / 24 / 17	36 / 30 / 24	44 / 35 / 28	54 / 41 / 29	84 / 54 / 41
Exterior Color		Morning Fog	Morning Fog	Morning Fog	Morning Fog	Morning Fog	Morning Fog
RAL Code		RAL 9001	RAL 9001	RAL 9001	RAL 9001	RAL 9001	RAL 9001
Dimensions (W x H x D)	Body	mm	1,067 x 635 x 203	1,067 x 635 x 203	1,067 x 635 x 203	1,345 x 635 x 203	1,345 x 635 x 203
	Shipping	mm	1,154 x 705 x 289	1,154 x 705 x 289	1,154 x 705 x 289	1,432 x 705 x 289	1,432 x 705 x 289
Fan	Type		Sirocco Fan	Sirocco Fan	Sirocco Fan	Sirocco Fan	Sirocco Fan
	Motor Output x Number	W x No.	19 x 1, 5 x 1	19 x 1, 5 x 1	19 x 1, 5 x 1	19 x 1, 5 x 1	19 x 2
	Air Flow Rate (H / M / L)	m ³ /min	8.5 / 7.5 / 6.5	9.5 / 8.5 / 7.5	10.5 / 9.5 / 8.5	11.5 / 10.0 / 9.5	16.0 / 14.0 / 12.0
	Motor Type		BLDC	BLDC	BLDC	BLDC	BLDC
Air Filter		Pre Filter	Pre Filter	Pre Filter	Pre Filter	Pre Filter	Pre Filter
Pipe Connections	Liquid Side	mm (inch)	Ø6.35 (1/4)	Ø6.35 (1/4)	Ø6.35 (1/4)	Ø6.35 (1/4)	Ø9.52 (3/8)
	Gas Side	mm (inch)	Ø12.7 (1/2)	Ø12.7 (1/2)	Ø12.7 (1/2)	Ø12.7 (1/2)	Ø15.88 (5/8)
	Drain Pipe (Internal Dia.)	mm (inch)	Ø12 (15/32)	Ø12 (15/32)	Ø12 (15/32)	Ø12 (15/32)	Ø12 (15/32)
Weight	Body kg	27.0	27.0	27.0	27.0	34.0	34.0
Sound Pressure Levels (H / M / L)	dB(A)	35 / 33 / 31	36 / 34 / 32	37 / 35 / 33	38 / 37 / 35	40 / 37 / 34	43 / 40 / 37
Sound Power Levels (H / M / L)	dB(A)	52 / 47 / 43	54 / 51 / 47	54 / 51 / 50	55 / 54 / 51	57 / 54 / 50	61 / 57 / 54
Power Supply	Ø, V, Hz	1, 220 - 240, 50	1, 220 - 240, 50	1, 220 - 240, 50	1, 220 - 240, 50	1, 220 - 240, 50	1, 220 - 240, 50
		1, 220, 60	1, 220, 60	1, 220, 60	1, 220, 60	1, 220, 60	1, 220, 60
Communication Cable	mm ² x No.	1.0 - 1.5 x 2C	1.0 - 1.5 x 2C	1.0 - 1.5 x 2C	1.0 - 1.5 x 2C	1.0 - 1.5 x 2C	1.0 - 1.5 x 2C

※ Nominal : Performance tested under EN14511
※ Rated : Max. power input allowed for fan motor

Note : 1. Capacities are based on the following conditions

- Cooling : Indoor temp. 27°C (80.6°F) DB / 19°C (66.2°F) WB, Outdoor temp. 35°C (95°F) DB / 24°C (75.2°F) WB, Interconnecting piping length 7.5m, Level difference of zero
- Heating : Indoor temp. 20°C (68°F) DB / 15°C (59°F) WB, Outdoor temp. 7°C (44.6°F) DB / 6°C (42.8°F) WB, Interconnecting piping length 7.5m, Level difference of zero
- 2. Due to our policy of innovation some specifications may be changed without notification
- 3. I.D : 'Internal Diameter'

Accessories

Chassis	ARNU07GCEA4	ARNU09GCEA4	ARNU12GCEA4	ARNU15GCEA4	ARNU18GCF4	ARNU24GCF4
Drain Pump			-			-
Cassette Cover			-			-
Refrigerant Leakage Detector		PRLDNV50			PRLDNV50	
EEV Kit		PRGK024A0				
Independent Power Module		PRIPO			PRIPO	
Robot Cleaner			-			-
Pre Filter (Washable / Anti-fungus)			○			○
Ion Generator			-			-
CO ₂ Sensor			-			-
Ventilation Kit			-			-
IR Receiver		PWLRVN000			PWLRVN000	
Zone Controller			-			-
Dry Contact (with Additional Accessory)		PDRYCB000 (1 point contact) PDRYCB300 (8 points for thermostat compatible) NEW PDRYCB320 (Universal input) ¹⁾ PDRYCB400 (2 points input) PDRYCB500 (Modbus)			PDRYCB000 (1 point contact) PDRYCB300 (8 points for thermostat compatible) NEW PDRYCB320 (Universal input) ¹⁾ PDRYCB400 (2 points input) PDRYCB500 (Modbus)	
External Input (1 point)			○			○
Wi-Fi		PWFMD200			PWFMD200	

※ ○ : Applied, - : Not applied
Option : Refer to model name in table
1) Available from April 2020

ARNU07GCEU4 / ARNU09GCEU4 / ARNU12GCEU4
ARNU15GCEU4 / ARNU18GCFU4 / ARNU24GCFU4



※ U : Floor Standing without case

Model	Unit	ARNU07GCEU4	ARNU09GCEU4	ARNU12GCEU4	ARNU15GCEU4	ARNU18GCFU4	ARNU24GCFU4
Cooling Capacity	kW	2.2	2.8	3.6	4.5	5.6	7.1
Heating Capacity	kW	2.5	3.2	4.0	5.0	6.3	8.0
Power Input (H / M / L)	Nominal W	24 / 17 / 14	30 / 24 / 17	36 / 30 / 24	44 / 35 / 28	54 / 41 / 29	84 / 54 / 41
Dimensions (W x H x D)	Body	mm	978 x 639 x 190	978 x 639 x 190	978 x 639 x 190	1,256 x 639 x 190	1,256 x 639 x 190
	Shipping	mm	1,055 x 702 x 260	1,055 x 702 x 260	1,055 x 702 x 260	1,333 x 702 x 260	1,333 x 702 x 260
Fan	Type		Sirocco Fan	Sirocco Fan	Sirocco Fan	Sirocco Fan	Sirocco Fan
	Motor Output x Number	W x No.	19 x 1, 5 x 1	19 x 1, 5 x 1	19 x 1, 5 x 1	19 x 1, 5 x 1	19 x 2
	Air Flow Rate (H / M / L)	m ³ /min	8.5 / 7.5 / 6.5	9.5 / 8.5 / 7.5	10.5 / 9.5 / 8.5	11.5 / 10.0 / 9.5	16.0 / 14.0 / 12.0
	Motor Type		BLDC	BLDC	BLDC	BLDC	BLDC
Air Filter		Pre Filter	Pre Filter	Pre Filter	Pre Filter	Pre Filter	Pre Filter
Pipe Connections	Liquid Side	mm (inch)	Ø6.35 (1/4)	Ø6.35 (1/4)	Ø6.35 (1/4)	Ø6.35 (1/4)	Ø9.52 (3/8)
	Gas Side	mm (inch)	Ø12.7 (1/2)	Ø12.7 (1/2)	Ø12.7 (1/2)	Ø12.7 (1/2)	Ø15.88 (5/8)
	Drain Pipe (Internal Dia.)	mm (inch)	Ø12 (15/32)	Ø12 (15/32)	Ø12 (15/32)	Ø12 (15/32)	Ø12 (15/32)
Weight	Body kg	20.0	20.0	20.0	20.0	26.0	26.0
Sound Pressure Levels (H / M / L)	dB(A)	35 / 33 / 31	36 / 34 / 32	37 / 35 / 33	38 / 37 / 35	40 / 37 / 34	43 / 40 / 37
Sound Power Levels (H / M / L)	dB(A)	52 / 47 / 43	54 / 51 / 47	54 / 51 / 50	55 / 54 / 51	57 / 54 / 50	61 / 57 / 54
Power Supply	Ø, V, Hz	1, 220 - 240, 50	1, 220 - 240, 50	1, 220 - 240, 50	1, 220 - 240, 50	1, 220 - 240, 50	1, 220 - 240, 50
		1, 220, 60	1, 220, 60	1, 220, 60	1, 220, 60	1, 220, 60	1, 220, 60
Communication Cable	mm ² x No.	1.0 - 1.5 x 2C	1.0 - 1.5 x 2C	1.0 - 1.5 x 2C	1.0 - 1.5 x 2C	1.0 - 1.5 x 2C	1.0 - 1.5 x 2C

※ Nominal : Performance tested under EN14511

※ Rated : Max. power input allowed for fan motor

Note : 1. Capacities are based on the following conditions

- Cooling : Indoor temp. 27°C (80.6°F) DB / 19°C (66.2°F) WB, Outdoor temp. 35°C (95°F) DB / 24°C (75.2°F) WB, Interconnecting piping length 7.5m, Level difference of zero
- Heating : Indoor temp. 20°C (68°F) DB / 15°C (59°F) WB, Outdoor temp. 7°C (44.6°F) DB / 6°C (42.8°F) WB, Interconnecting piping length 7.5m, Level difference of zero
- 2. Due to our policy of innovation some specifications may be changed without notification
- 3. I.D : 'Internal Diameter'

Accessories

Chassis	ARNU07GCEU4	ARNU09GCEU4	ARNU12GCEU4	ARNU15GCEU4	ARNU18GCFU4	ARNU24GCFU4
Drain Pump			-			-
Cassette Cover			-			-
Refrigerant Leakage Detector		PRLDNV50			PRLDNV50	
EEV Kit		PRGK024A0				
Independent Power Module		PRIPO			PRIPO	
Robot Cleaner			-			-
Pre Filter (Washable / Anti-fungus)			○			○
Ion Generator			-			-
CO ₂ Sensor			-			-
Ventilation Kit			-			-
IR Receiver		PWLRVN000			PWLRVN000	
Zone Controller			-			-
Dry Contact (with Additional Accessory)		PDRYCB000 (1 point contact) PDRYCB300 (8 points for thermostat compatible) NEW PDRYCB320 (Universal input) ¹⁾ PDRYCB400 (2 points input) PDRYCB500 (Modbus)			PDRYCB000 (1 point contact) PDRYCB300 (8 points for thermostat compatible) NEW PDRYCB320 (Universal input) ¹⁾ PDRYCB400 (2 points input) PDRYCB500 (Modbus)	
External Input (1 point)			○			○
Wi-Fi		PWFMD200			PWFMD200	

※ ○ : Applied, - : Not applied
Option : Refer to model name in table
1) Available from April 2020

COMPATIBILITY

No.	New Function Name (4 th generation indoor)	Function Description	Required Controller		Remarks
			Wired Remote Controller	Centralized Controller	
1	Energy Monitoring (Accumulated Electric Energy Check)	Monitoring accumulated power consumption by Wired Remote Controller	○	○	* Necessary to install the PDI (Power Distribution Indicator) and central controller * Combined with MULTI V Water S outdoor unit, this function is not available.
		Monitoring accumulated power consumption by Central Control Device / PDI	-	○	* Necessary to install the PDI (Power Distribution Indicator) * To make a report, central controller must be installed
2	2 Set Point	1) 2 set point control by Indoor and Central controller 2) Synchronization function with remote control (Synchronization Setting and Monitoring)	○	○	* Wired remote controller and central controller must be installed * Combined with MULTI V Water S outdoor unit, this function is not available.
3	Occupied / Unoccupied Scheduling Function (Sub Func. Enable)	1) Synchronization according to occupied / unoccupied by Indoor and Central control 2) Synchronization icon with remote controller (Synchronization Monitoring)	○	○	* Centralized control is able to when you combine only 4 th generation indoor units (Use together with 2 nd generation and 4 th generation indoors, only wired remote controller is able to set this function as existing way) * Wired remote controller or central controller must be installed (Function can be activated using just one control device.) * Combined with MULTI V Water S outdoor unit, this function is not available.
4	Group Control	Group Control can use Additional function	○	○	* Check more details in PDB (Product Data Book) * Central controller can create and control group.
5	Test Run (Heating)	Test run mode can be operated in cooling mode and heating mode for easy service	○	-	
6	Model Information Monitoring	Product Type / Indoor Type / Indoor capacity information can be monitored by remote controller	○	-	
7	Indoor unit address checking	Wired remote controller can check indoor unit address information	○	-	
8	Refrigerant Leakage Detection	Function error sign display when refrigerant leakage occurred	○	○	* Central controller has been installed, CH230 error code can be recognized (Old/New Same) * Without Central Controller, it is able to recognize with wired remote controller (CH230) * Combined with MULTI V Water S outdoor unit, this function is not available. * Accessory PRLDNV50 must be separately ordered
9	Thermo On / Off range Setting (Cooling)	User can set cooling thermo On / Off range with wired remote controller for prevention overcooling	○	-	* Thermo On / Off temperature setting (3 step)
10	Thermo On / Off range Setting (Heating)	User can set heating thermo On / Off range with wired remote controller for prevention overheating. (4 Steps)	○	-	* Thermo On / Off temperature setting (4 step)
11	Static Pressure 11 Step Control (Only for Ceiling Concealed Duct Type)	Depends on the installation environment, 4 th generation Ceiling Concealed Duct can control the static pressure by 11 steps for providing comfortable environment	○	-	* Only applied in Ceiling Concealed Duct
12	1 point External Input (On / Off control)	Indoor unit can control external devices without purchasing Dry contact as an accessory (All 4 th generation indoors)	○	-	* Simple On / Off control by Dry Contact at Indoor [Example of Contact port by product type] * 2 Way Cassette : CN-CC Port (Wired remote controller installation function mode 41 is required) * 1 Way / 4 Way Cassette / Ceiling Concealed Duct / Wall Mounted Unit Console / FAU / Floor Standing (with case / without case) : CN-EXT Port
13	Filter Sign (Remaining Time)	The alarm activates when the filter needs to be cleaned, and the time remaining for cleaning is displayed on the screen.	○	○	* The alarm activates on the central controller, but the remaining time is not displayed.
14	Auto restart function Disable / Enable	After the power failure compensation, stand by at OFF mode Restore the operation for the status before the power off	○	-	
15	Indoor Humidity display	Monitoring indoor humidity Wired Remote Controller	○	○	* Available only with MULTI V 5
16	Comfort Cooling setting	set the outdoor unit Comfort cooling operation value	○	○	* Available only with MULTI V 5
17	Smart Load Control setting	Change the outdoor unit's Smart Load Control stage value.	○	○	* Available only with MULTI V 5
18	ODU Refrigerant Noise Reduction setting	set the outdoor unit's refrigerant noise reduction function	○	○	* Available only with MULTI V 5
19	Low noise mode time setting	set the start and end time of the outdoor unit's low noise mode operation	○	○	* Available only with MULTI V 5

Note : 1. No.1, 2, 3, 8 : Functions are available to use together with 4th generation Indoor units only. If used together 2nd generation indoor unit and 4th generation indoor unit functions will not be activate. Combined with MULTI V WATER S outdoor unit this function is not available
 2. No. 4, 5, 6, 7, 9, 10, 11, 12, 13, 14 : If used together 2nd generation indoor unit and 4th generation indoor unit these functions will be activate only in 4th generation indoor
 3. 2nd generation indoor unit : Ceiling & Floor Convertible Unit, Ceiling Suspended Unit, HYDRO KIT (Low Temp. / High Temp.), ERV DX (with Humidifier, without Humidifier), AHU Communication Kit

FEATURE FUNCTIONS

Premium (PREMTA000 PREMTA000A PREMTA000B)	Wired Remote Controller				Centralized Controller				
	Standard III (PREMTB100) (PREMTBB10)	Standard II (PREMTB01) (PREMTB001)	Simple		AC EZ (PQCSZ250S0)	AC EZ Touch (PACEZA000)	AC Smart 5 (PACS5A000)	ACP 5 (PACP5A000)	AC Manager 5 (PACM5A000)
			Simple for Hotel (PQRCHCA0Q/QW)	Simple (PQRCVCL0Q/QW)					
○	○	○	-	-	-	○	○	○	○
-	-	-	-	-	-	○	○	○	○
○	○	-	-	-	-	○	○	○	○
○	○	-	-	-	-	○	○	○	○
○	○	○	-	-	-	-	○	○	○
○	○	○	-	-	-	-	-	-	-
○	○	○	-	-	-	-	-	-	-
○	○	○	-	-	-	-	○	○	-
○	○	○	-	-	-	-	-	-	-
○ (4 step)	○ (4 step)	○ (3 step)	○ (3 step)	○ (3 step)	-	-	-	-	-
○	○	○	○	○	-	-	-	-	-
-	○	○	-	-	-	-	-	-	-
○	○	○	-	-	○	○	○	○	○
○	○	○	-	-	-	-	-	-	-
-	○	-	-	-	-	-	○	○	-
-	○	-	-	-	-	-	○	○	-
-	○	-	-	-	-	-	○	○	-
-	○	-	-	-	-	○	○	○	-

※ ○ : Applied, - : Not applied

COMPATIBILITY

Controller Product		Premium	Standard III		Standard II		Simple		Simple for Hotel		Wireless	Dry Contact			
		PREMTA000 PREMTA000A PREMTA000B	PREMTB100	PREMTB100	PREMTB001	PREMTB001	PQRCVCLQ	PQRCVCLQW	PQRCHA0Q	PQRCHA0QW	NEW PWLSSB21H (H/P) PWLSSB21C (C/O)	Simple Dry Contact PDRYCB000	2 points Dry Contact PDRYCB400	Dry Contact for Thermostat PDRYCB300 NEW PDRYCB320 ²⁾	For Modbus PDRYCB500
Ceiling Mounted Cassette	Smart Dual Vain Cassette	○	○	○	○	○	○	○	○	○	○	○	○	○	○
	Round Cassette	○	○	○	○	○	○	○	○	○	○	○	○	○	○
	4 Way	○	○	○	○	○	○	○	○	○	○	○	○	○	○
	2 Way / 1 Way	○	○	○	○	○	○	○	○	○	○	○	○	○	○
Ceiling Concealed Duct	High Sensible	○	○	○	○	○	○	○	○	△	○	○	○	○	○
	High / Mid Statics	○	○	○	○	○	○	○	○	△	○	○	○	○	○
	Low Statics	○	○	○	○	○	○	○	○	△	○	○	○	○	○
FAU (Fresh Air Intake Unit)	○	○	○	○	○	○	○	○	○	△	○	○	○	○	○
MULTI V	Convertible & Ceiling Suspended Unit	○	○	○	○	○	○	○	○	○	○	○	○	○	○
	Console	○	○	○	○	○	○	○	○	○	○	○	○	○	○
	Floor Standing Unit	○	○	○	○	○	○	○	○	○	○	○	○	○	○
Wall Mounted Unit		○	○	○	○	○	○	○	○	○	○	○	○	○	○
		○	○	○	○	○	○	○	○	○	○	○	○	○	○
HYDRO KIT ¹⁾	○	○	○	○	○	○	○	○	○	○	○	○	○	○	○
Ventilation	Energy Recovery Ventilator	○	○	○	○	○	○	○	○	○	○	○	○	○	○
	Energy Recovery Ventilator with DX coil	○	○	○	○	○	○	○	○	○	○	○	○	○	○
AHU Communication Kit	○	○	○	○	○	○	○	○	○	△	○	○	○	○	○

※ ○: Compatible, △: Need wired remote controller / IR receiver, -: Not compatible
 1) It has a separate remote controller 2) Available from April 2020

FEATURE FUNCTIONS

Controller Name	Wired Remote Controller					Wireless Remote Controller	Wi-Fi Controller																																																																																								
	Premium	Standard III	Standard II	Simple	Simple (Hotel)																																																																																										
Model Name																																																																																															
	PREMTA000 PREMTA000A PREMTA000B	PREMTB100 PREMTB100	PREMTB001 PREMTB001	PQRCVCLQ PQRCVCLQW	PQRCHA0Q PQRCHA0QW	NEW PWLSSB21H (H/P) PWLSSB21C (C/O)	PWFMDD200																																																																																								
Basic	<table border="1"> <tr><td>On / Off</td><td>○</td><td>○</td><td>○</td><td>○</td><td>○</td><td>○</td><td>○</td></tr> <tr><td>Fan Speed Control</td><td>○</td><td>○</td><td>○</td><td>○</td><td>○</td><td>○</td><td>○</td></tr> <tr><td>Temperature Setting</td><td>○</td><td>○</td><td>○</td><td>○</td><td>○</td><td>○</td><td>○</td></tr> <tr><td>Mode Change</td><td>○</td><td>○</td><td>○</td><td>○</td><td>-</td><td>○</td><td>○</td></tr> <tr><td>Auto Swing</td><td>○</td><td>○</td><td>○</td><td>○</td><td>○</td><td>○</td><td>○</td></tr> <tr><td>Vane Control (Louver Angle)</td><td>○</td><td>○</td><td>○</td><td>○</td><td>○</td><td>○</td><td>○</td></tr> <tr><td>E.S.P (External Static Pressure)</td><td>○</td><td>○</td><td>○</td><td>○</td><td>○</td><td>-</td><td>-</td></tr> <tr><td>Electric Failure Compensation</td><td>○</td><td>○</td><td>○</td><td>○</td><td>○</td><td>-</td><td>○</td></tr> <tr><td>Indoor Temperature Display</td><td>○</td><td>○</td><td>○</td><td>○</td><td>○</td><td>○</td><td>○</td></tr> <tr><td>ALL Button Lock (Child Lock)</td><td>○</td><td>○</td><td>○</td><td>○</td><td>○</td><td>-</td><td>-</td></tr> </table>							On / Off	○	○	○	○	○	○	○	Fan Speed Control	○	○	○	○	○	○	○	Temperature Setting	○	○	○	○	○	○	○	Mode Change	○	○	○	○	-	○	○	Auto Swing	○	○	○	○	○	○	○	Vane Control (Louver Angle)	○	○	○	○	○	○	○	E.S.P (External Static Pressure)	○	○	○	○	○	-	-	Electric Failure Compensation	○	○	○	○	○	-	○	Indoor Temperature Display	○	○	○	○	○	○	○	ALL Button Lock (Child Lock)	○	○	○	○	○	-	-								
On / Off	○	○	○	○	○	○	○																																																																																								
Fan Speed Control	○	○	○	○	○	○	○																																																																																								
Temperature Setting	○	○	○	○	○	○	○																																																																																								
Mode Change	○	○	○	○	-	○	○																																																																																								
Auto Swing	○	○	○	○	○	○	○																																																																																								
Vane Control (Louver Angle)	○	○	○	○	○	○	○																																																																																								
E.S.P (External Static Pressure)	○	○	○	○	○	-	-																																																																																								
Electric Failure Compensation	○	○	○	○	○	-	○																																																																																								
Indoor Temperature Display	○	○	○	○	○	○	○																																																																																								
ALL Button Lock (Child Lock)	○	○	○	○	○	-	-																																																																																								
Advanced	<table border="1"> <tr><td>Schedule / Timer</td><td>Weekly-Yearly</td><td>Weekly-Yearly</td><td>Weekly</td><td>-</td><td>-</td><td>Sleep / On / Off</td><td>Weekly</td></tr> <tr><td>Additional Mode Setting¹⁾</td><td>○</td><td>○</td><td>○</td><td>-</td><td>-</td><td>-</td><td>-</td></tr> <tr><td>Time Display</td><td>○</td><td>○</td><td>○</td><td>-</td><td>-</td><td>○</td><td>-</td></tr> <tr><td>Humid. Display</td><td>○</td><td>○</td><td>-</td><td>-</td><td>-</td><td>-</td><td>-</td></tr> <tr><td>Advanced Lock (mode, set point, set point range, On / Off Lock)</td><td>Advanced Lock</td><td>Advanced Lock</td><td>-</td><td>-</td><td>-</td><td>-</td><td>-</td></tr> <tr><td>Filter Sign</td><td>○</td><td>○</td><td>○</td><td>-</td><td>-</td><td>-</td><td>-</td></tr> <tr><td>Energy Management²⁾</td><td>○</td><td>○</td><td>○</td><td>-</td><td>-</td><td>-</td><td>-</td></tr> <tr><td>Dual Set Point</td><td>○</td><td>○</td><td>-</td><td>-</td><td>-</td><td>-</td><td>-</td></tr> <tr><td>Human Detection</td><td>-</td><td>○</td><td>-</td><td>-</td><td>-</td><td>-</td><td>-</td></tr> <tr><td>Temp, Humidity Compensation</td><td>○</td><td>○</td><td>-</td><td>-</td><td>-</td><td>-</td><td>-</td></tr> <tr><td>Wifi AP mode setting</td><td>○</td><td>○</td><td>○</td><td>○</td><td>○</td><td>○</td><td>-</td></tr> </table>							Schedule / Timer	Weekly-Yearly	Weekly-Yearly	Weekly	-	-	Sleep / On / Off	Weekly	Additional Mode Setting ¹⁾	○	○	○	-	-	-	-	Time Display	○	○	○	-	-	○	-	Humid. Display	○	○	-	-	-	-	-	Advanced Lock (mode, set point, set point range, On / Off Lock)	Advanced Lock	Advanced Lock	-	-	-	-	-	Filter Sign	○	○	○	-	-	-	-	Energy Management ²⁾	○	○	○	-	-	-	-	Dual Set Point	○	○	-	-	-	-	-	Human Detection	-	○	-	-	-	-	-	Temp, Humidity Compensation	○	○	-	-	-	-	-	Wifi AP mode setting	○	○	○	○	○	○	-
Schedule / Timer	Weekly-Yearly	Weekly-Yearly	Weekly	-	-	Sleep / On / Off	Weekly																																																																																								
Additional Mode Setting ¹⁾	○	○	○	-	-	-	-																																																																																								
Time Display	○	○	○	-	-	○	-																																																																																								
Humid. Display	○	○	-	-	-	-	-																																																																																								
Advanced Lock (mode, set point, set point range, On / Off Lock)	Advanced Lock	Advanced Lock	-	-	-	-	-																																																																																								
Filter Sign	○	○	○	-	-	-	-																																																																																								
Energy Management ²⁾	○	○	○	-	-	-	-																																																																																								
Dual Set Point	○	○	-	-	-	-	-																																																																																								
Human Detection	-	○	-	-	-	-	-																																																																																								
Temp, Humidity Compensation	○	○	-	-	-	-	-																																																																																								
Wifi AP mode setting	○	○	○	○	○	○	-																																																																																								
ETC	<table border="1"> <tr><td>Operation Status LED</td><td>○</td><td>○</td><td>○</td><td>○</td><td>○</td><td>-</td><td>-</td></tr> <tr><td>Wireless Remote Controller Receiver</td><td>○³⁾</td><td>-</td><td>○³⁾</td><td>○³⁾</td><td>○³⁾</td><td>-</td><td>-</td></tr> <tr><td>Display</td><td>5 inch Color</td><td>4.3 inch Color</td><td>4.3 inch Mono</td><td>2.6 inch Mono</td><td>2.6 inch Mono</td><td>2 inch Mono</td><td>-</td></tr> <tr><td>Size (W x H x D, mm)</td><td>137 x 121 x 16.5</td><td>120 x 120 x 16</td><td>120 x 120 x 16</td><td>64 x 120 x 15</td><td>64 x 120 x 15</td><td>51 x 153 x 26</td><td>-</td></tr> <tr><td>Black Light Control for Screen Saver</td><td>○</td><td>○</td><td>-</td><td>-</td><td>-</td><td>-</td><td>-</td></tr> </table>							Operation Status LED	○	○	○	○	○	-	-	Wireless Remote Controller Receiver	○ ³⁾	-	○ ³⁾	○ ³⁾	○ ³⁾	-	-	Display	5 inch Color	4.3 inch Color	4.3 inch Mono	2.6 inch Mono	2.6 inch Mono	2 inch Mono	-	Size (W x H x D, mm)	137 x 121 x 16.5	120 x 120 x 16	120 x 120 x 16	64 x 120 x 15	64 x 120 x 15	51 x 153 x 26	-	Black Light Control for Screen Saver	○	○	-	-	-	-	-																																																
Operation Status LED	○	○	○	○	○	-	-																																																																																								
Wireless Remote Controller Receiver	○ ³⁾	-	○ ³⁾	○ ³⁾	○ ³⁾	-	-																																																																																								
Display	5 inch Color	4.3 inch Color	4.3 inch Mono	2.6 inch Mono	2.6 inch Mono	2 inch Mono	-																																																																																								
Size (W x H x D, mm)	137 x 121 x 16.5	120 x 120 x 16	120 x 120 x 16	64 x 120 x 15	64 x 120 x 15	51 x 153 x 26	-																																																																																								
Black Light Control for Screen Saver	○	○	-	-	-	-	-																																																																																								

※ ○: Applied, -: Not Applied
 1) It might not be indicated or operated at the partial product
 2) Centralized control (PACEZA000 / PACS5A000 / PACPSA000 / PLNWK000) and PDI (PQNUD1S40 / PPWRDB000) should be installed for this function
 3) For ceiling type duct
 Note : 1. Indoor unit should have functions requested by the controller
 2. If you need more detail, please refer to the manual of product. (<http://partner.lge.com>: Home> Doc.Library> Manual)

INDOOR UNITS

HOT WATER SOLUTIONS

• HYDRO KIT



HYDRO KIT

HYDRO KIT Features

Features & Benefits

- Lower operation cost compared to fossil fuel-based systems such as boilers.
- More energy saving through MULTI V Heat Recovery system.

Key Applications

- Where hot water is needed such as domestic hot water, in-floor or radiant heat. Where cold water is needed such as fan coil unit and chilled beam.

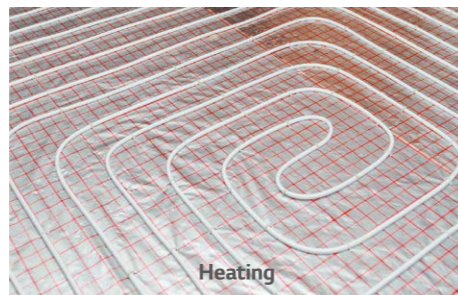
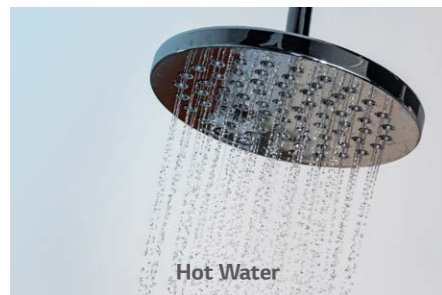

Radiant Heating / Cooling

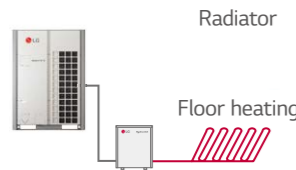

Fan Coil Unit Heating / Cooling

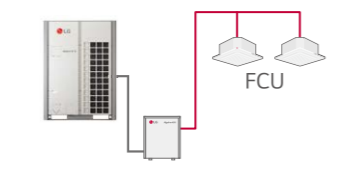

Hot water / Cooled Water

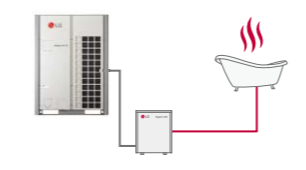

Combination

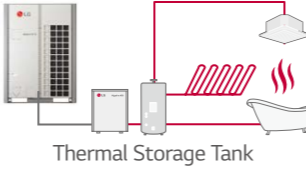
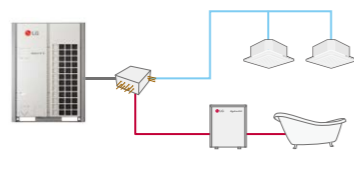
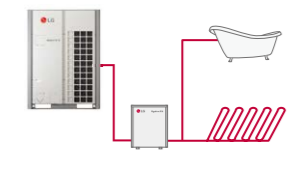

Hot water+ Radiant heating

HR unit (Cooling & Hot water)

Thermal Storage Tank
Thermal Storage System

System Diagram

Providing a total solution by heat pump, air conditioning (Cooling by refrigerant & chilled water, Heating by refrigerant & hot water) and domestic hot water supply.

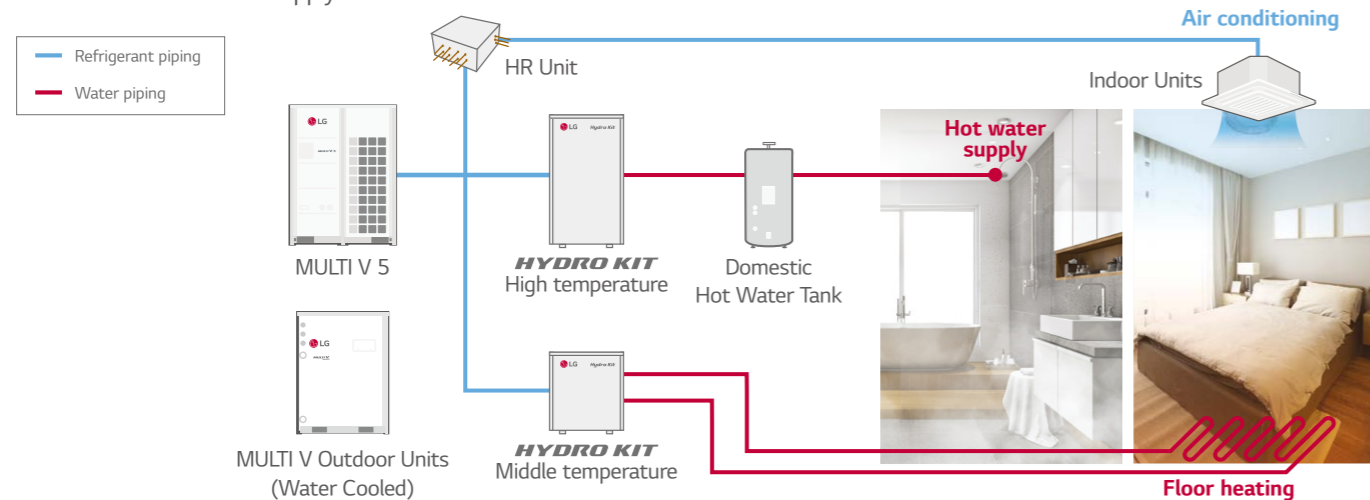

Eco-friendly Green Energy Solution

Green energy solution through the reduction of CO₂ emissions.



Conventional System



HYDRO KIT

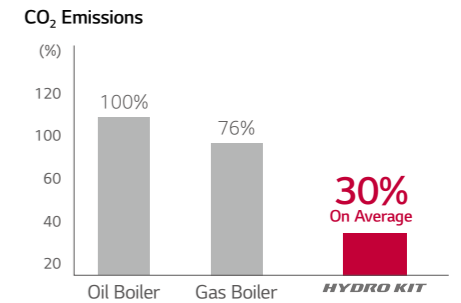

Saving Cost through High Efficiency

Possible to install with equivalent levels of capital cost as a boiler system and minimise energy bills thanks to lower operation costs.

1st Proposal MULTI V 5 HYDRO KIT

(Air Conditioning + Hot Water Supply + Floor Heating)

2nd Proposal MULTI V 5 Air-Conditioning + Gas Boiler

(Hot Water Supply + Floor Heating)

3rd Proposal MULTI V 5 Air-Conditioning + Oil Boiler

(Hot Water Supply + Floor Heating)

Analysis Conditions

- Building Type : Dormitory, Flats
- Cooling / Floor Heating / Sanitary Hot Water for 10 years
- Cooling : MULTI V IV Indoor Unit
- Floor Heating : Medium Temp. HYDRO KIT (1ea)
- Sanitary Hot Water : High Temp. HYDRO KIT (2ea), Sanitary Hot Water Tanks
- Electricity Cost : Average Cost in EU
- Gas Cost : Average Cost in EU
- Oil Cost : Average Cost in EU

Initial Costs

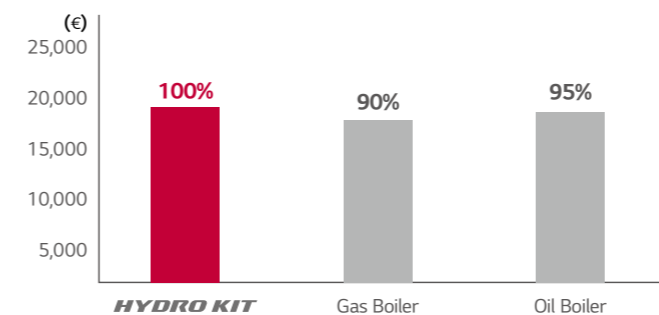

Annual Operating Costs

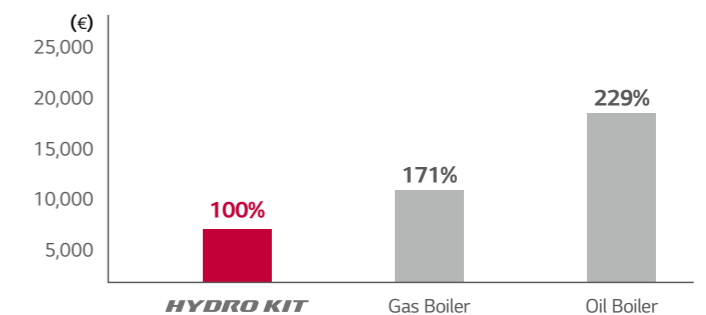

LCC

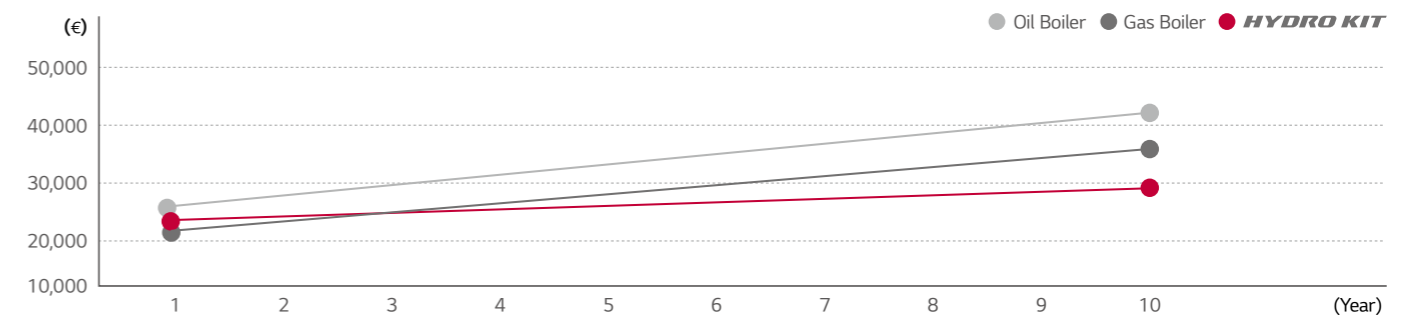

HYDRO KIT

Energy Saving through MULTI V 5 Heat Recovery

Energy costs can be minimized by reusing the wasted heat from indoor units.

Conventional

Absorbed heat is released to outdoor air.

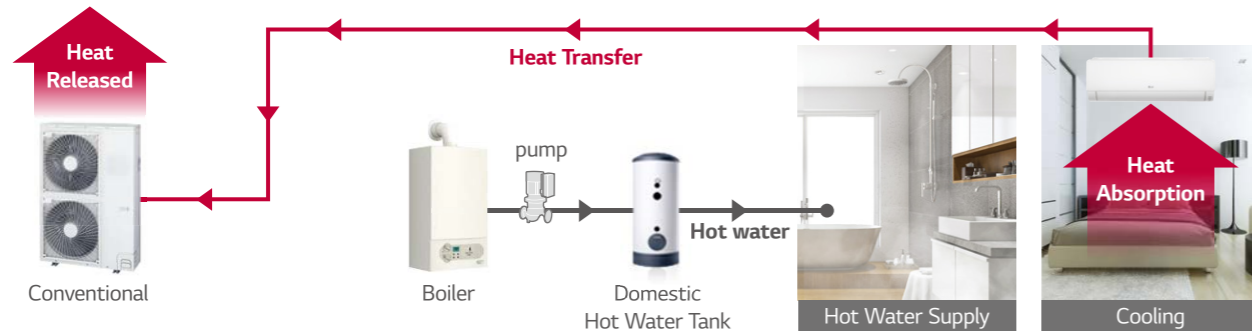

HYDRO KIT

Absorbed heat from indoor space is used for making hot water.

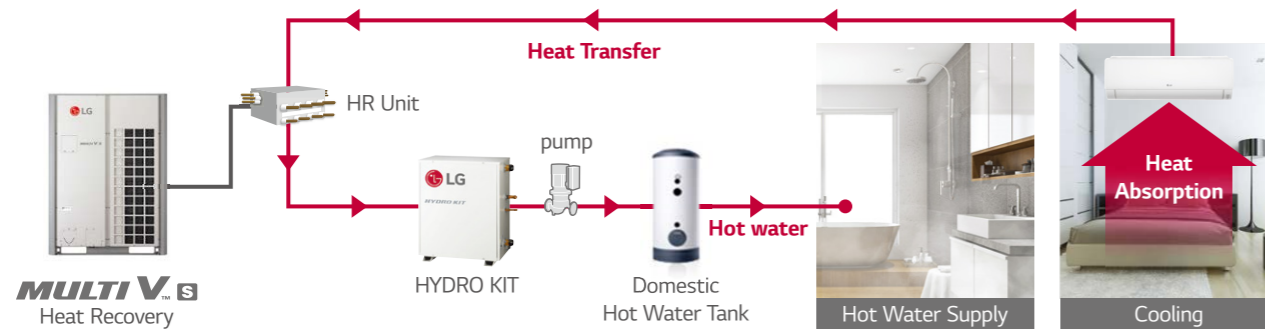

High Temperature Concept of HYDRO KIT

Provides high temperature up to 80°C with dual inverter cascade cycle, applicable for buildings that require large amount of hot water supply.

Dual Inverter Cascade Cycle Technology

- Max 55% improved capacity compared to mid-temp. of HYDRO KIT.
- Max 20% reduced heating operating cost compared to mid-temp. of HYDRO KIT.
- Cascade R410A to R134A BLDC compressor technology.

High Volume of Hot Water

Compared to lower temperature, storing high temperature water in a sanitary tank increases the quantity of mixed water available for the user.

High Temperature HYDRO KIT Cycle Diagram

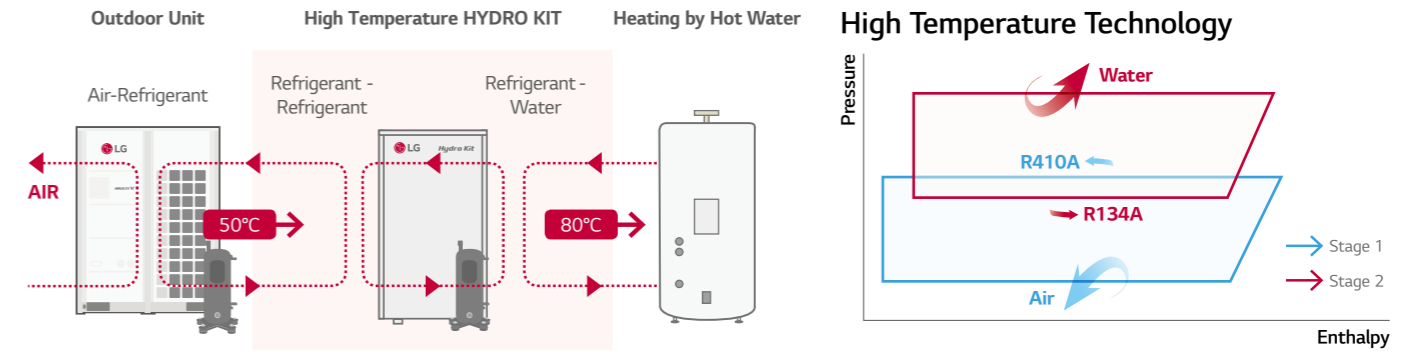

Various Applications

Applicable to a variety of facilities including hospitals, residences and resorts that need floor heating and domestic hot water supply.

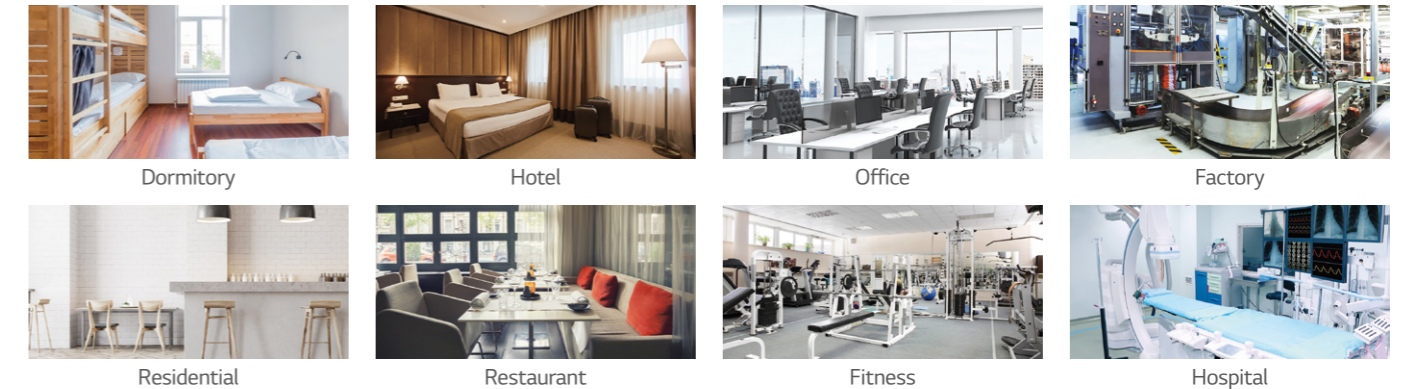

HOT WATER SOLUTIONS

Hotel Application

It is possible to operate cooling and heating constantly at the same time during the summer, to provide hot water for bathrooms by using waste heat energy of indoor cooling.

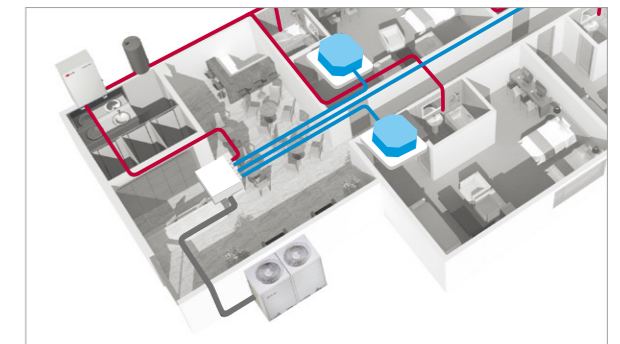

Office Application

Hot water can be supplied at all times in the office by cooling the HR unit to warm up the sanitary tank, using waste energy.

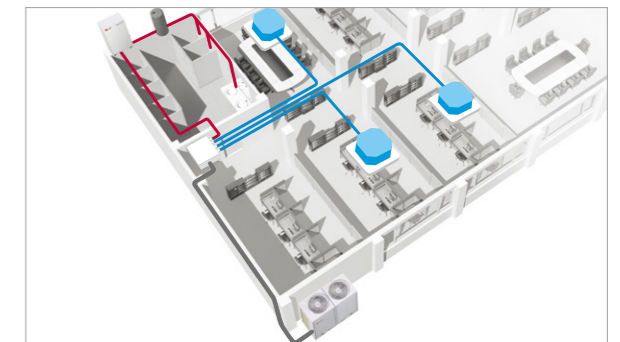

HYDRO KIT

ARNH04GK2A4 / ARNH10GK2A4



Model	Unit	ARNH04GK2A4	ARNH10GK2A4
Cooling Capacity	kW	12.3	28.0
Heating Capacity	kW	13.8	31.5
Power Input	Nominal W	10	10
Exterior Color		Morning Gray	Morning Gray
RAL Code		RAL 7030	RAL 7030
Dimensions (W x H x D)	Body	mm 520 x 631 x 330	mm 520 x 631 x 330
	Shipping	mm 677 x 687 x 418	mm 677 x 687 x 418
Pipe Connections	Liquid Side	mm (inch) Ø9.52 (3/8)	mm (inch) Ø9.52 (3/8)
	Gas Side	mm (inch) Ø15.88 (5/8)	mm (inch) Ø22.2 (7/8)
	Drain Pipe (Internal Dia.)	A (inch) 25A (Male PT 1)	A (inch) 25A (Male PT 1)
Water Pipe Connections	Inlet	A (inch) 25A (Male PT 1)	A (inch) 25A (Male PT 1)
	Outlet	A (inch) 25A (Male PT 1)	A (inch) 25A (Male PT 1)
Weight	Body kg	29.2	33.7
Sound Pressure Levels (H / M / L)	dB(A)	26	26
Power Supply	Ø, V, Hz	1, 220 - 240, 50	1, 220 - 240, 50
		1, 220, 60	1, 220, 60
Communication Cable	mm ² x No.	1.0 - 1.5 x 2C	1.0 - 1.5 x 2C

※ Nominal : Performance tested under EN14511

Note : 1. Capacities are based on the following conditions :

- Cooling : Indoor 27°C (80.6°F) DB / 19° C (66.2°F) WB, Outdoor 35°C (95°F) DB / 24°C (75.2°F) WB, Water Inlet 23°C (73.4°F) / Outlet 18°C (64.4°F)
- Heating : Indoor 20°C (68°F) DB / 15°C (59°F) WB, Outdoor 7°C (44.6°F) DB / 6°C (42.8°F) WB, Water Inlet 30°C (86°F) / Outlet 35°C (95°F)

2. Piping Length : Interconnected Pipe Length = 7.5m

3. Difference Limit of Elevation (Outdoor - Indoor Unit) is Zero.

4. MULTI V S 4HP (ARUN040GSS0, ARUN040LSS0) cannot be connected to HYDRO KIT.

5. MULTI V WATER S cannot be connected to HYDRO KIT.

6. Anti freezing liquid should be added under 10°C (Outdoor temp.) during cooling mode.

Accessories

Chassis	ARNH04GK2A4	ARNH10GK2A4
Drain Pump		-
Cassette Cover		-
Refrigerant Leakage Detector		PRLDNVSO
EEV Kit		-
Independent Power Module		○
Robot Cleaner		-
Pre Filter (Washable / Anti-fungus)		-
Ion Generator		-
CO ₂ Sensor		-
Ventilation Kit		-
IR Receiver		-
Zone Controller		-
Dry Contact (with Additional Accessory)		PDRYCB000 (1 point contact) PDRYCB300(8 points for thermostat compatible) NEW PDRYCB320 (Universal input) ¹⁾
External Input (1 point)		○
Wi-Fi		PWFMD200

※ ○ : Applied, - : Not applied

Option : Refer to model name in table

1) Available from April 2020

ARNH04GK3A4/ ARNH08GK3A4



Model	Unit	ARNH04GK3A4	ARNH08GK3A4
Heating Capacity	kW	13.8	25.2
Power Input	Nominal W	2,300	5,000
Exterior Color		Morning Gray	Morning Gray
RAL Code		RAL 7030	RAL 7030
Dimensions (W x H x D)	Body	mm 520 x 1,080 x 330	mm 520 x 1,080 x 330
	Shipping	mm 682 x 1,168 x 423	mm 682 x 1,168 x 423
Pipe Connections	Liquid Side	mm (inch) Ø9.52 (3/8)	mm (inch) Ø9.52 (3/8)
	Gas Side	mm (inch) Ø15.88 (5/8)	mm (inch) Ø19.05 (3/4)
	Drain Pipe (Internal Dia.)	A (inch) 25A (Male PT 1)	A (inch) 25A (Male PT 1)
Water Pipe Connections	Inlet	A (inch) 25A (Male PT 1)	A (inch) 25A (Male PT 1)
	Outlet	A (inch) 25A (Male PT 1)	A (inch) 25A (Male PT 1)
Weight	Body kg	87.0	91.0
Sound Pressure Levels (H / M / L)	dB(A)	43	46
Power Supply	Ø, V, Hz	1, 220 - 240, 50	1, 220 - 240, 50
		1, 220, 60	1, 220, 60
Communication Cable	mm ² x No.	1.0 - 1.5 x 2C	1.0 - 1.5 x 2C

※ Nominal : Performance tested under EN14511

Note : 1. Capacities are based on the following conditions :

- Heating : Indoor 20°C (68°F) DB / 15°C (59°F) WB, Outdoor 7°C (44.6°F) DB / 6°C (42.8°F) WB, Water Inlet 55°C (131°F) / Outlet 65°C (149°F)

2. Piping Length : Interconnected Pipe Length = 7.5m

3. Difference Limit of Elevation (Outdoor - Indoor Unit) is Zero.

4. MULTI V S 4HP (ARUN040GSS0, ARUN040LSS0) cannot be connected to HYDRO KIT.

5. MULTI V WATER S cannot be connected to HYDRO KIT.

Accessories

Chassis	ARNH04GK3A4	ARNH08GK3A4
Drain Pump		-
Cassette Cover		-
Refrigerant Leakage Detector		PRLDNVSO
EEV Kit		-
Independent Power Module		○
Robot Cleaner		-
Pre Filter (Washable / Anti-fungus)		-
Ion Generator		-
CO ₂ Sensor		-
Ventilation Kit		-
IR Receiver		-
Zone Controller		-
Dry Contact (with Additional Accessory)		PDRYCB000 (1 point contact) PDRYCB300(8 points for thermostat compatible) NEW PDRYCB320 (Universal input) ¹⁾
External Input (1 point)		○
Wi-Fi		PWFMD200

※ ○ : Applied, - : Not applied

Option : Refer to model name in table

1) Available from April 2020

VENTILATION SOLUTIONS

- ERV
- ERV WITH DX COIL



ERV

Necessity of ERV

Natural ventilation loss cooling, heating energy when exhausting polluted air inside. Heat exchanger in ERV collects the cooling, heating energy to save energy while supplying fresh air.

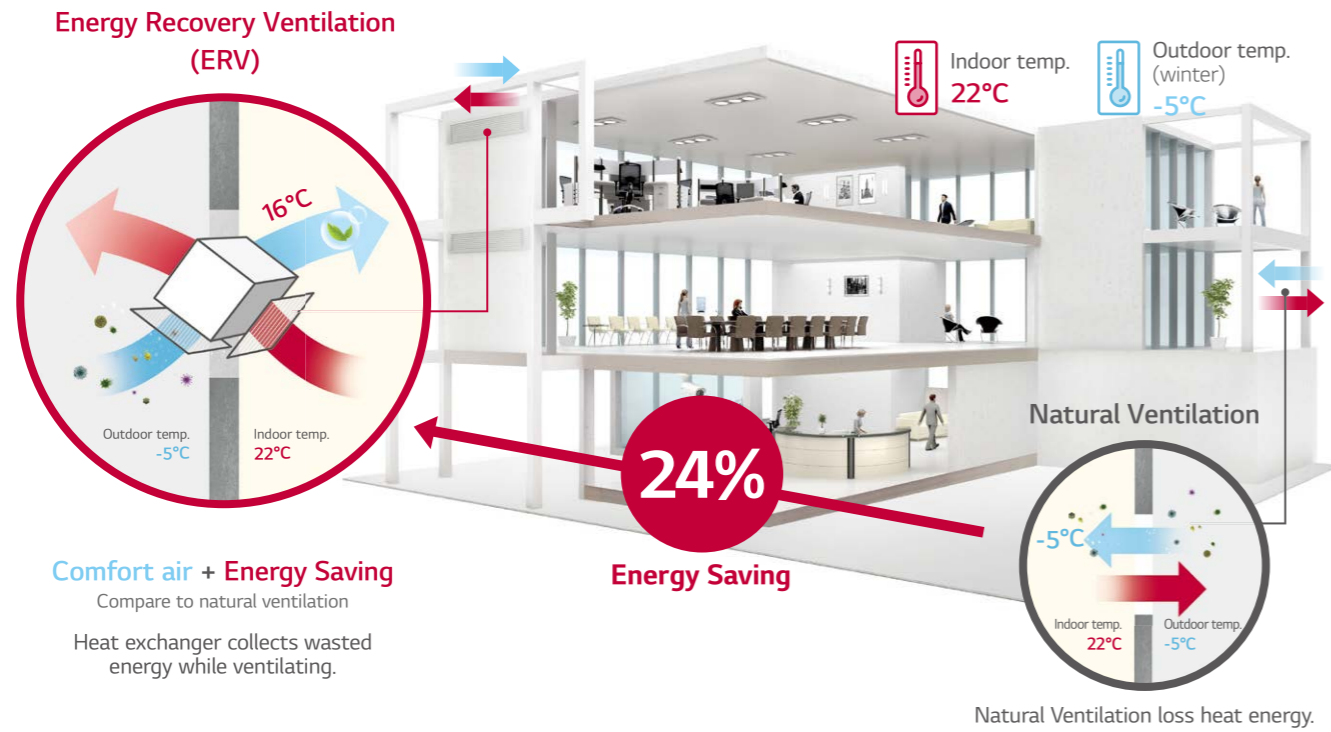

Interlocking with Air Conditioning System

- LG ERV can be interlocked with air conditioners and controlled individually.
- This function can be operated when the system is connected with a remote control.

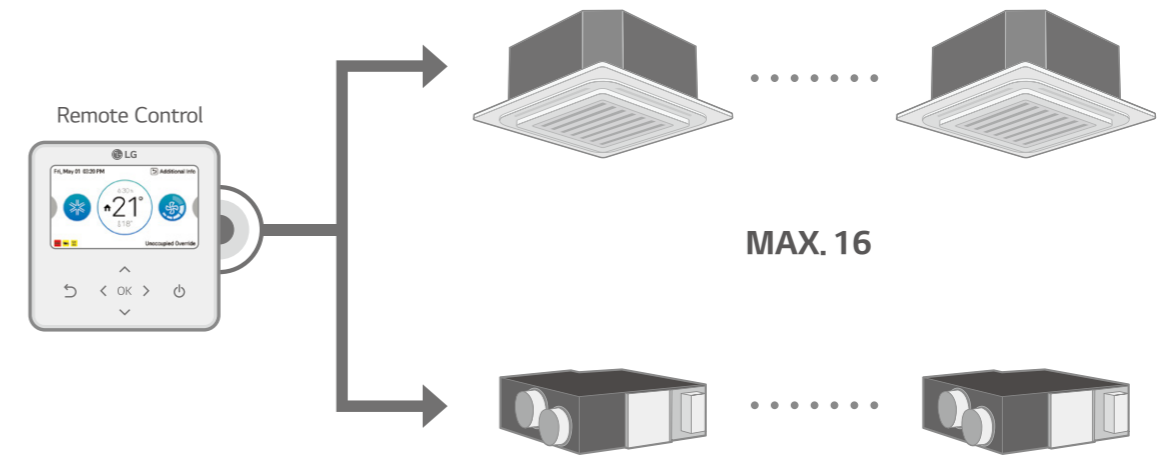

High Efficiency Heat Exchanger

Efficiency and comfort is ensured through the high-efficiency energy recovery central core which recovers energy from the indoor air and transfers it to the fresh incoming air without mixing airstream.

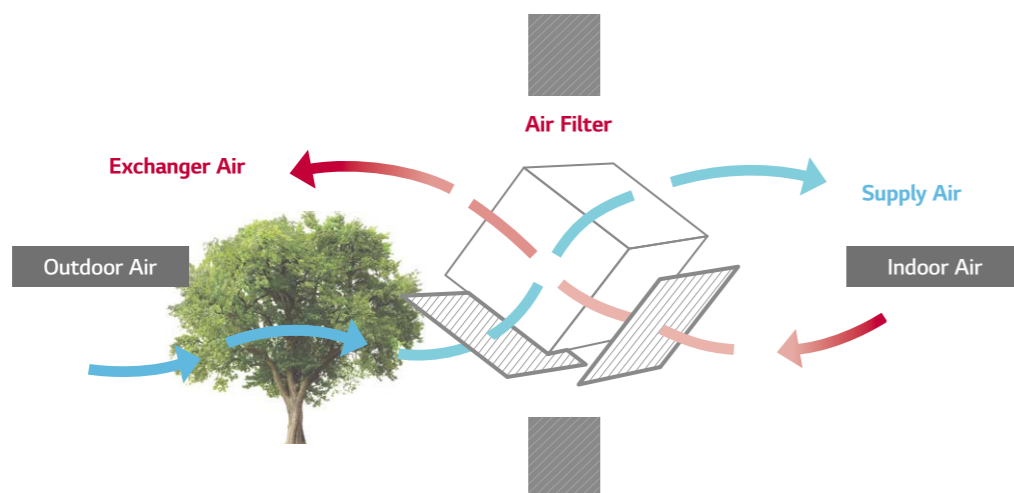

Compulsory Exhausting System

The exhausting system using high static and sirocco fan removes contaminants effectively from indoor air. Supply and exhaust air flows are completely separated in the total heat exchanger, LG ERV can filter out the impurities before supplying outdoor air and make indoor air fresh and healthy.

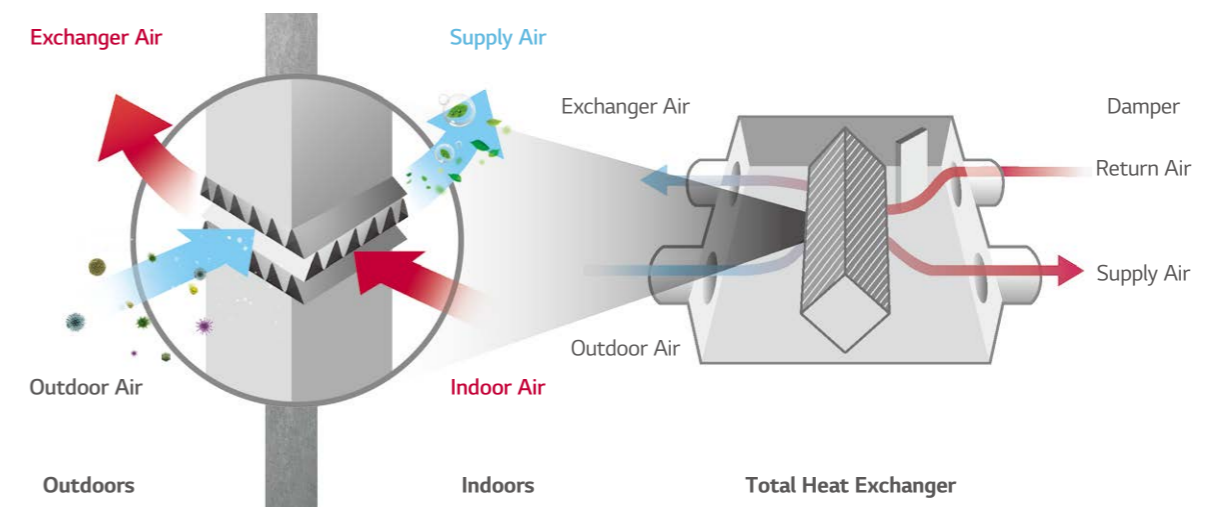

ERV

Night Time Free Cooling

Discharge the indoor heat in the summer night and supply cool outdoor air to indoors. so it can save energy.

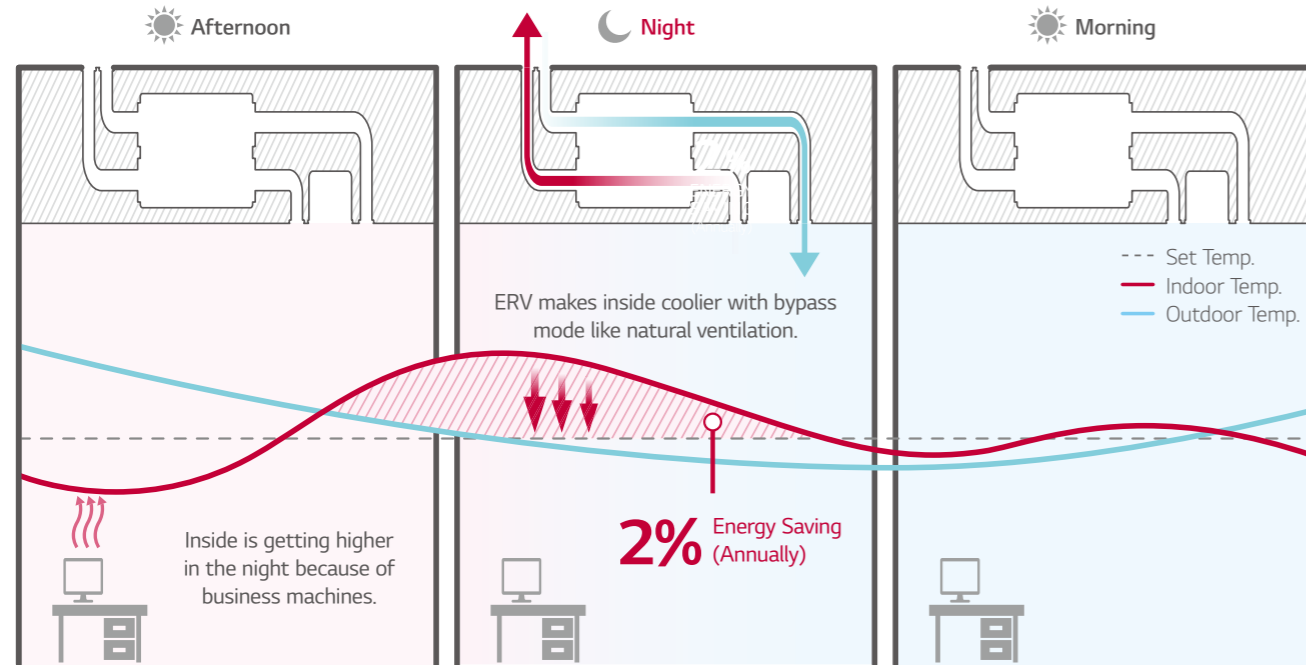

※ This function is operated with 'Night Time Free Cooling' on remote controller. (with MULTI V only)
 ※ Energy saving ratio can be differed by weather condition.
 ※ Test Condition
 - Office (49,000ft²) / Occupancy : 30 / Area : London, UK
 - ERV (1000 CMH) + MULTI V 4 (12HP) Unit Combination
 - Other conditions are subject to BREEAM.

CO₂ Auto Operation

LG ERV reduces energy loss with auto fan speed control following CO₂ level

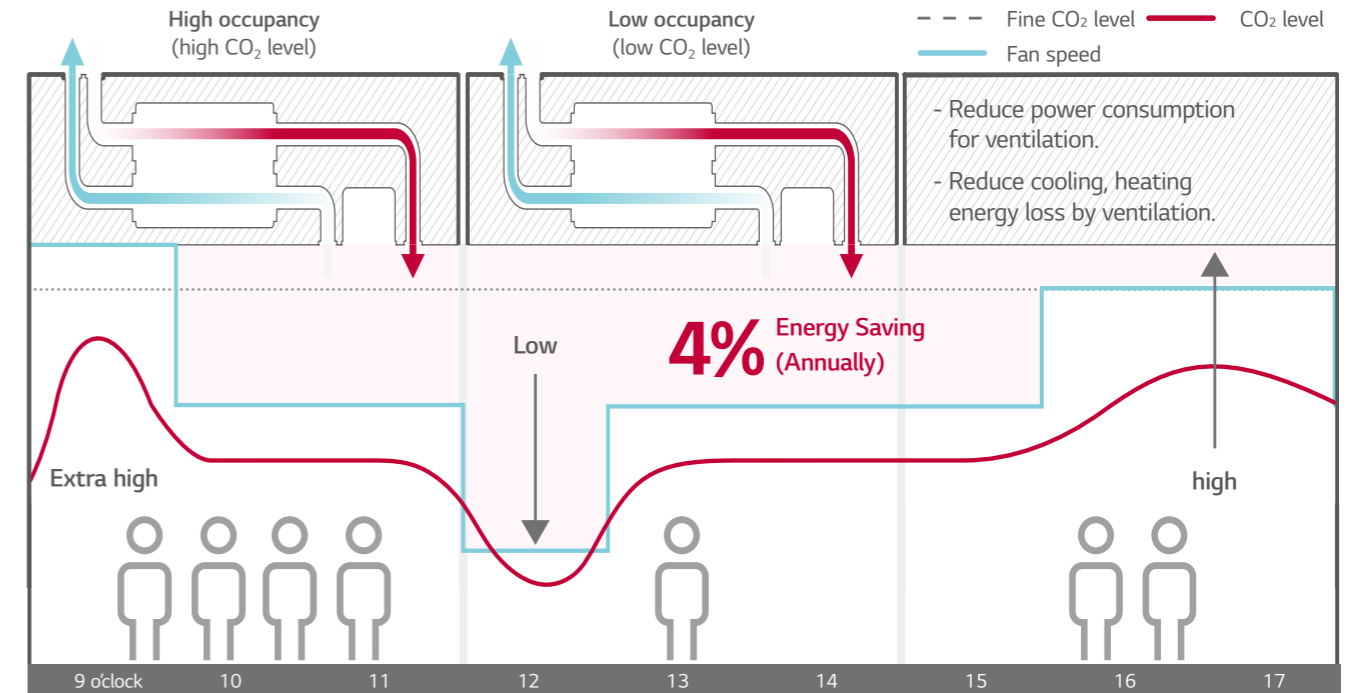

※ This function is operated with 'Night Time Free Cooling' on remote controller. (with MULTI V only)
 ※ Energy saving ratio can be differed by weather condition.
 ※ Test Condition
 - Office (49,000ft²) / Occupancy : 30 / Area : London, UK
 - ERV (1000 CMH) + MULTI V 4 (12HP) Unit Combination
 - Other conditions are subject to BREEAM.

Delay Operation

When you turn on the air conditioner and ERV at the same time, Delay Operation can reduce unnecessary heating and cooling energy loss slows down automatically ERV operation.

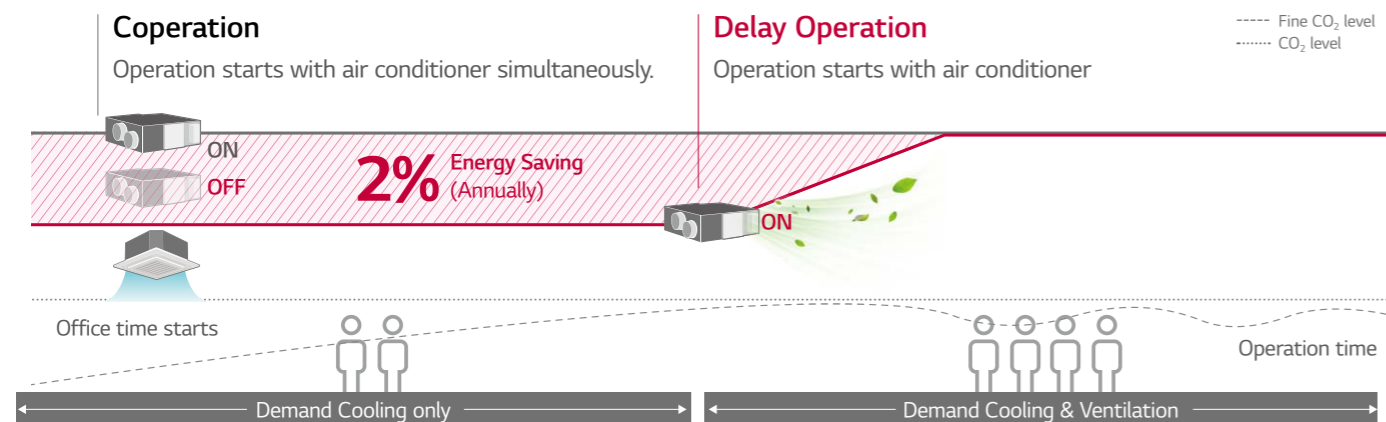

※ This function is operated with 'Night Time Free Cooling' on remote controller. (with MULTI V only)
 ※ Energy saving ratio can be differed by weather condition.
 ※ Test Condition
 - Office (49,000ft²) / Occupancy : 30 / Area : London, UK
 - ERV (1000 CMH) + MULTI V 4 (12HP) Unit Combination
 - Other conditions are subject to BREEAM.

Seasonal Auto Operation

LG ERV senses outdoor temperature and operates automatically following weather condition.

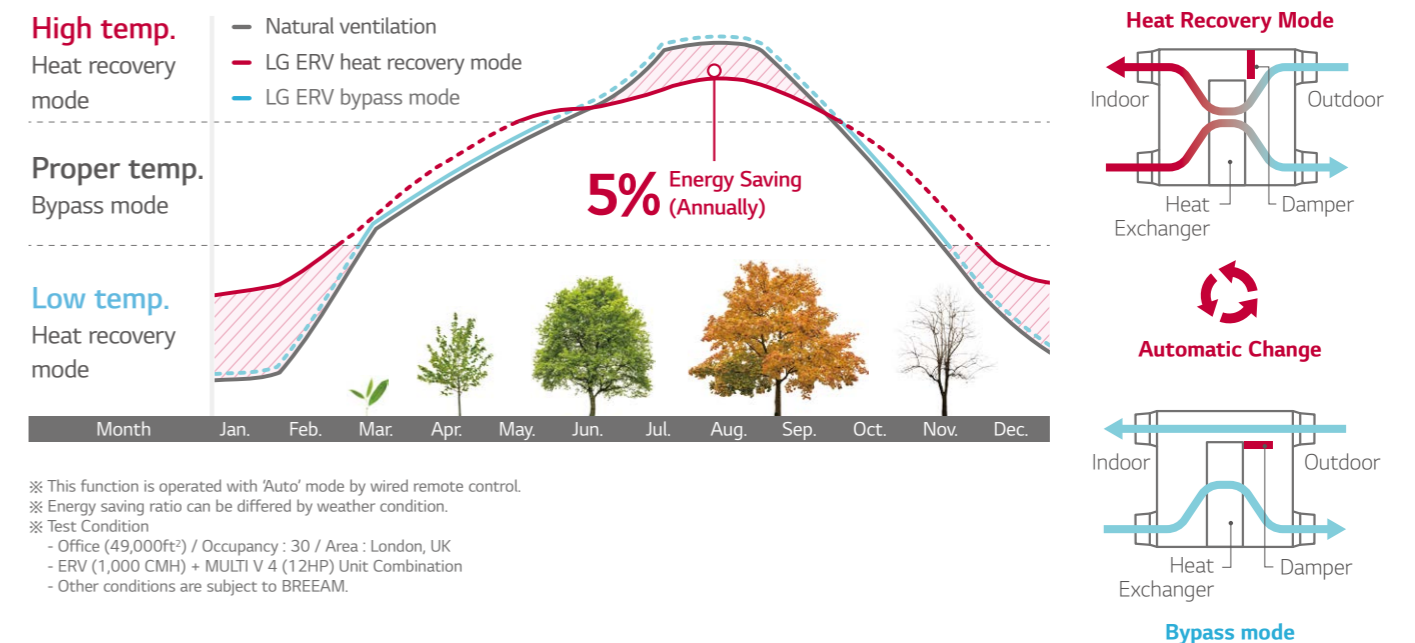

※ This function is operated with 'Auto' mode by wired remote control.
 ※ Energy saving ratio can be differed by weather condition.
 ※ Test Condition
 - Office (49,000ft²) / Occupancy : 30 / Area : London, UK
 - ERV (1,000 CMH) + MULTI V 4 (12HP) Unit Combination
 - Other conditions are subject to BREEAM.

ERV

CO₂ Level Monitoring

CO₂ sensor senses CO₂ level in the room. Users can monitor CO₂ level on new wired remote controller, and ERV controls the fan speed automatically following the level.

CO₂ Level Visualization

CO₂ sensor senses indoor CO₂ level and displays it on new wired remote controller.

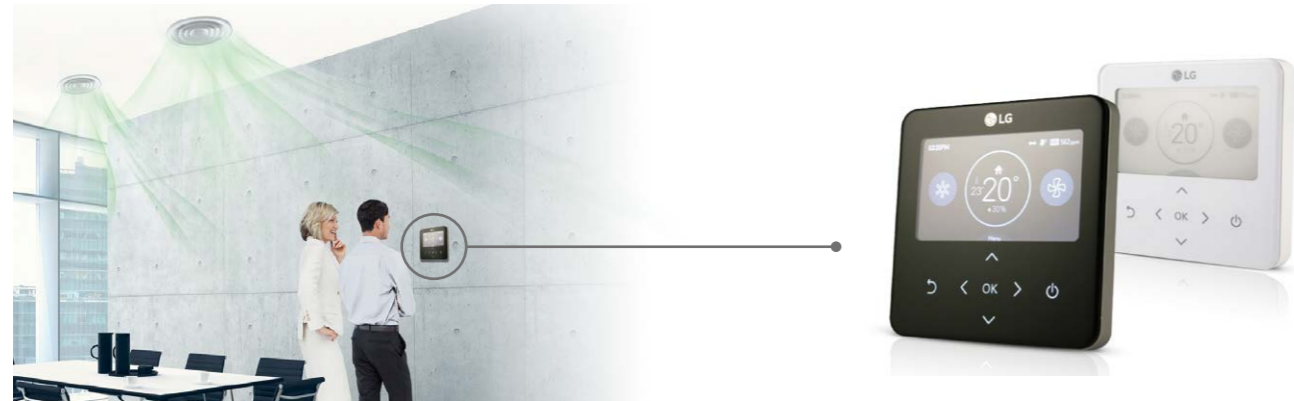

Main Display

If the CO₂ level is above 900ppm in the room, the red mark is on.



※ The remote controller screen image may change.
 ※ Applicable to only Standard III, Premium remote controller.

Further Information

CO₂ level and room condition are displayed continuously.

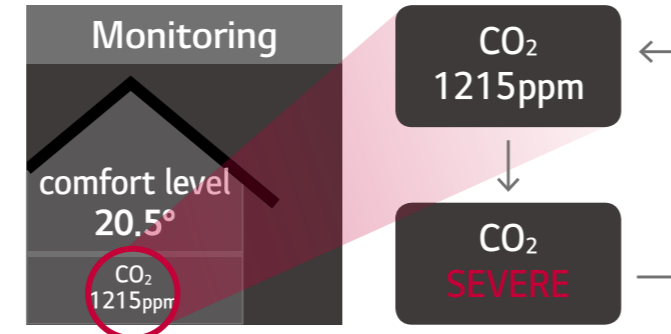

CO₂ Concentration Control

Using CO₂ sensor, LG ERV controls exhaust air flow automatically to keep indoor air fresh under settled CO₂ concentration.

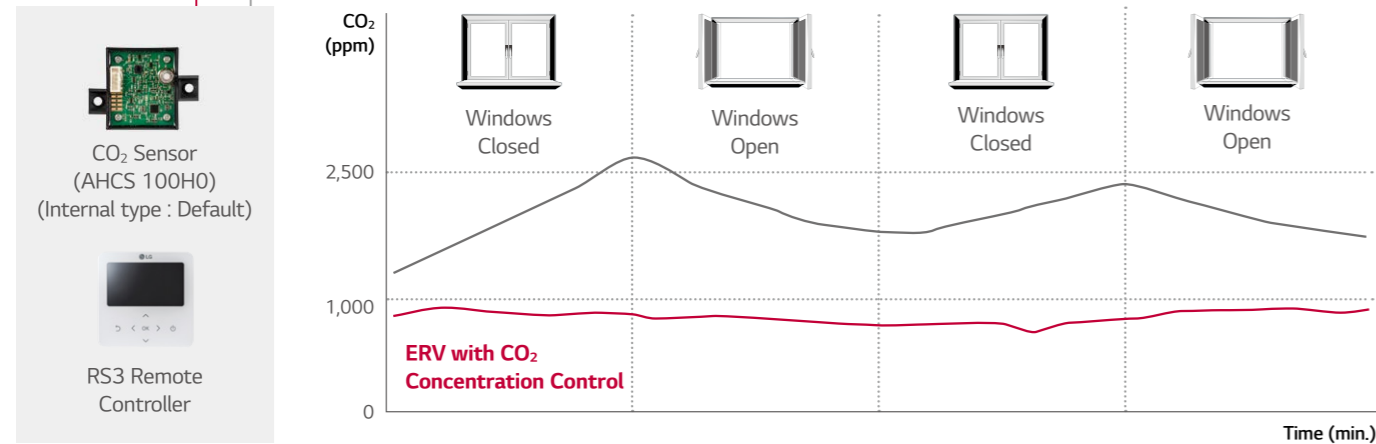
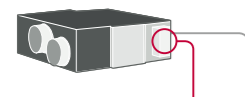

External Static Pressure Control

The high static pressure fan can control the air volume depending on the length of the duct. It is also easy to control the pressure level by using the remote controller for a more flexible duct installation and easier testing.

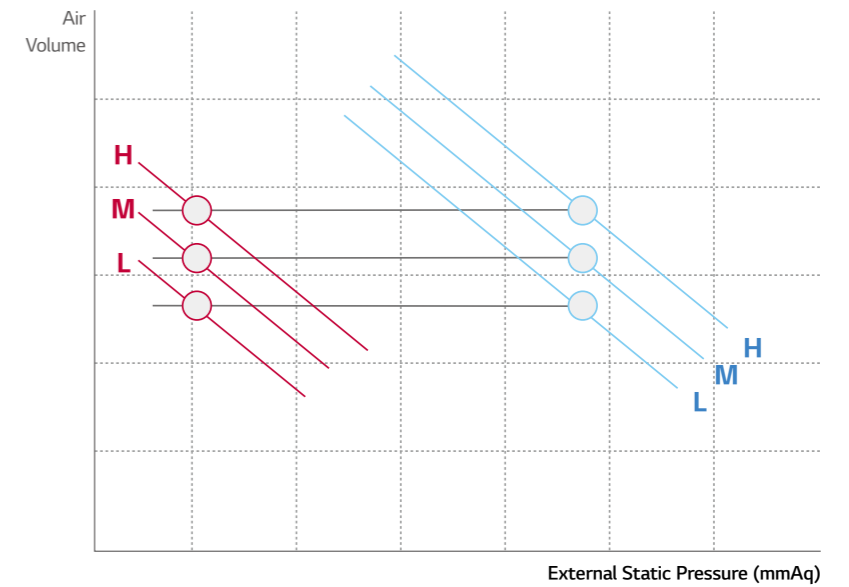

Fast Ventilation Mode

Fast ventilation mode prevents the spread of contaminants under negative indoor pressure, and makes indoor air fresh and comfortable quickly.

Only Exhausting

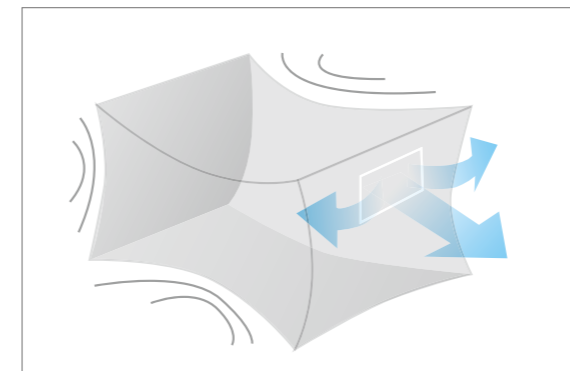

Exhausting operation causes negative indoor air pressure, and cannot fully ventilate.

Fast Ventilation Mode

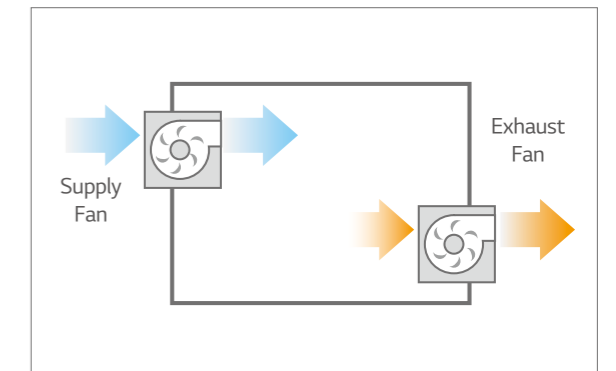

Exhausting and Supplying Simultaneously

ERV

High Durability

LG ERV durability is increased through bacteria-resistant material of heat exchanger and corrosion protection coating. It prevents shortening product life due to corrosion and mold and supplies high quality air to inside by minimizing the bacteria.

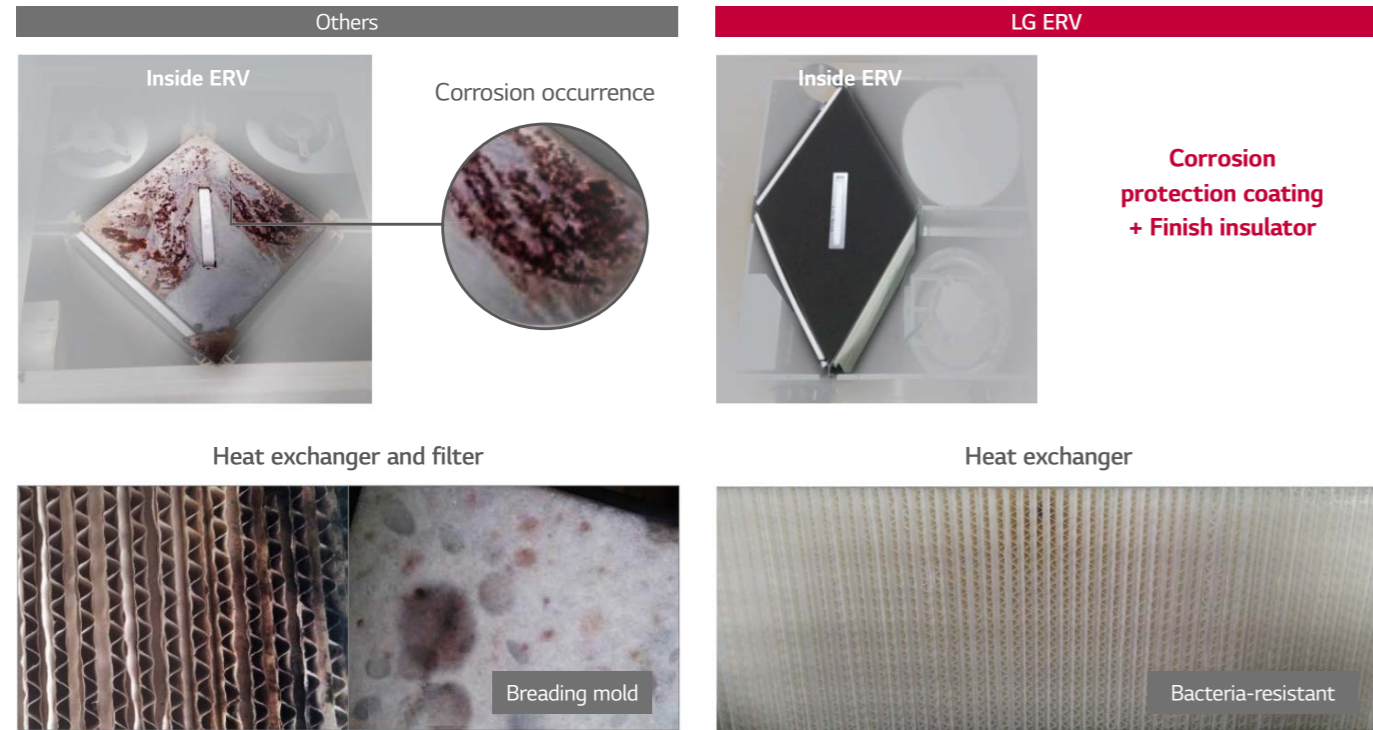

Easy Controller

Wired remote controller is easy for usage.

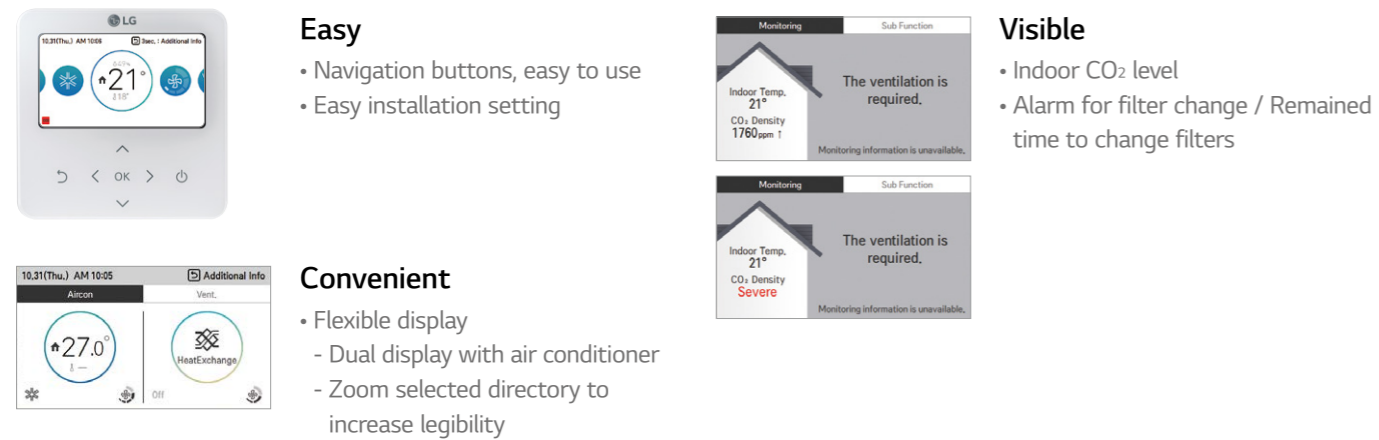

Group Control

One wired remote control up to sixteen ERV (Including air conditioning) you can reduce the remote installation costs and enjoy good looking interior wall effect.

Several units combination

16 units group control is available with 1 remote controller.



※ 16 units (Including ERV, air conditioner) + 1 remote controller

Good looking interior

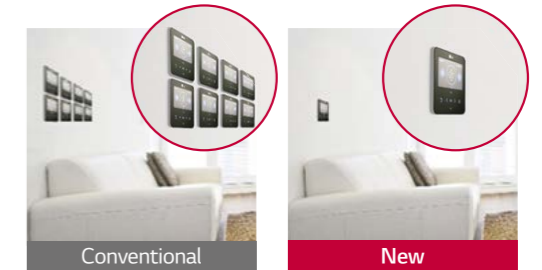

Controller & installation cost saving



Easy Cleaning and Filter Change

It is easy and convenient to change and clean the filter.

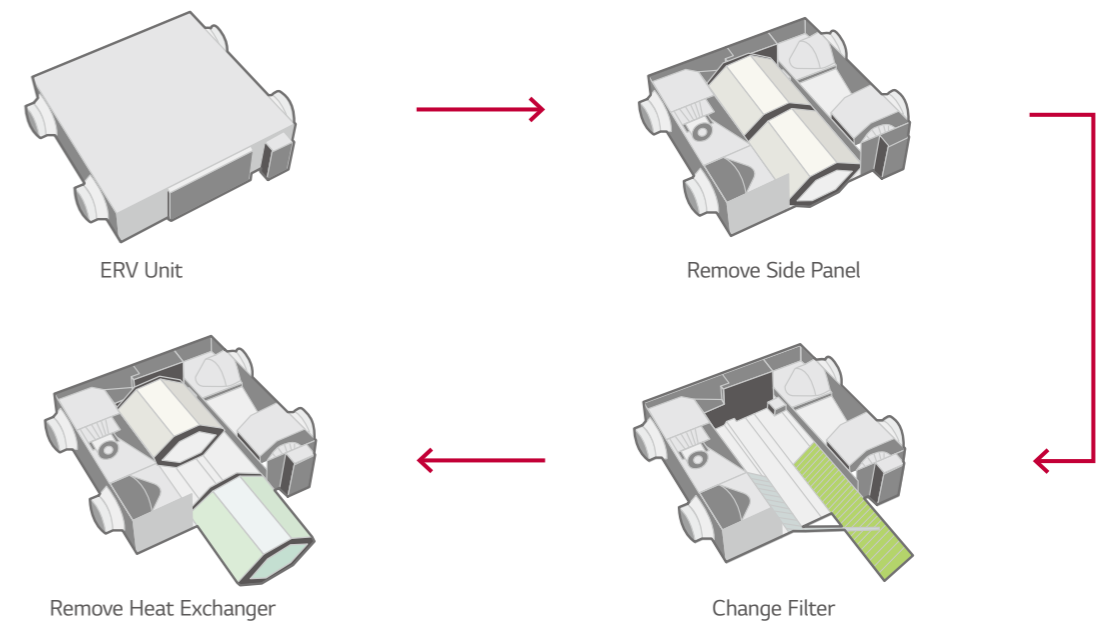

ERV

LZ-H025GBA4 / LZ-H035GBA4 / LZ-H050GBA4



Model		LZ-H025GBA4	LZ-H035GBA4	LZ-H050GBA4
Nominal Capacity	CMH (CFM)	250 (147)	350 (206)	500 (294)
Power Supply	Ø, V, Hz	1, 220 - 240, 50 / 60		
ERV Mode	Step	SUPER-HIGH / HIGH / LOW		
	Current	SH / H / L	Amps	0.70 / 0.60 / 0.42
	Power Input	SH / H / L	W	97 / 78 / 52
	Air Flow	SH / H / L	CMH (CFM)	250 / 250 / 150 (147 / 147 / 88)
	External Static Pressure	SH / H / L	Pa (inWTR)	100 / 70 / 50 (0.40 / 0.28 / 0.20)
	Temperature Exchange Efficiency	SH / H / L	%	80 / 80 / 83
	Enthalpy Exchange Efficiency	Heating (SH / H / L) %		70 / 70 / 72
		Cooling (SH / H / L) %		66 / 66 / 68
	Noise Level (Sound Level, 1.5m)	SH / H / L	dB(A)	29 / 28 / 24
Bypass Mode	Step	SUPER-HIGH / HIGH / LOW		
	Current	SH / H / L	Amps	0.70 / 0.60 / 0.42
	Power Input	SH / H / L	W	97 / 78 / 52
	Air Flow	SH / H / L	CMH (CFM)	250 / 250 / 150 (147 / 147 / 88)
	External Static Pressure	SH / H / L	Pa (inWTR)	100 / 70 / 50 (0.40 / 0.28 / 0.20)
Heat Exchanger	Type	Air to air cross flow heat exchange		
Net Weight	kg	44	44	44
Dimension	W x H x D	mm	988 x 273 x 1,014	988 x 273 x 1,014
Duct Work*	Qty	EA	4	
	Size (Ø)	mm	Ø200	
Supply Air Fan	Qty	EA	1	
	Type	-	Direct-Drive (Sirocco Fan)	
Exhaust Air Fan	Qty	EA	1	
	Type	-	Direct-Drive (Sirocco Fan)	
Filters (Default)	Qty	EA	2	2
	Type	-	Cleanable fibrous fleeces	
Filters (Optional)	Size (W x H x D)	mm	855 x 10 x 160	855 x 6 x 230
	Model	-	AHFT035H0	AHFT050H0
	Qty	EA	2	2
	Type	-	F7	F7
Dry Contact		PDRYCB000		

- Note : 1. ERV mode : Total Heat Recovery Ventilation mode
 2. * : Refer to dimensional drawings.
 3. Noise level : - The operating conditions are assumed to be standard.
 - Sound measured at 1.5m below the center the body.
 - Sound level will vary depending on a range of factors such as the construction(Acoustic absorption coefficient) of particular room in which the equipment is installed.
 - The sound level at the air discharge port is about 8 dB(A) higher than the unit's operating sound.
 4. Temperature and Enthalpy Exchange Efficiency at cooling Indoor Temperature : 26.5°C DB, 64.5% RH, Outdoor Temperature : 34.5°C DB, 75% RH
 5. Temperature and Enthalpy Exchange Efficiency at heating Indoor Temperature : 20.5°C DB, 59.5% RH, Outdoor Temperature : 5°C DB, 65% RH
 6. Temperature Exchange efficiency is tested at heating condition.
 7. F7 Filter is 2 pieces in 1 filter package.

Premium	Standard III	Standard II	CO ₂ Sensor
PREMTA000 PREMTA000A PREMTA000B	PREMTB100	PREMTBB10	AHCS100H0 (Internal Type)
PREMTBB01	PREMTB001		

LZ-H080GBA4 / LZ-H100GBA4
 LZ-H150GBA4 / LZ-H200GBA4

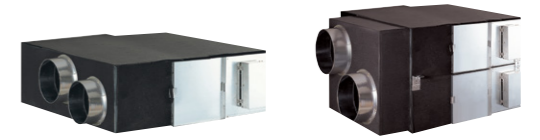

Model		LZ-H080GBA4	LZ-H100GBA4	LZ-H150GBA4	LZ-H200GBA4
Nominal Capacity	CMH (CFM)	800 (471)	1,000 (589)	1,500 (883)	2,000 (1,177)
Power Supply	Ø, V, Hz	1, 220 - 240, 50 / 60			
ERV Mode	Step	SUPER-HIGH / HIGH / LOW			
	Current	SH / H / L	Amps	2.77 / 2.16 / 1.44	3.41 / 2.90 / 1.76
	Power Input	SH / H / L	W	390 / 280 / 187	480 / 385 / 210
	Air Flow	SH / H / L	CMH (CFM)	800 / 800 / 660 (471 / 471 / 388)	1,000 / 1,000 / 800 (589 / 589 / 471)
	External Static Pressure	SH / H / L	Pa (inWTR)	200 / 110 / 60 (0.80 / 0.44 / 0.24)	160 / 90 / 50 (0.64 / 0.36 / 0.20)
	Temperature Exchange Efficiency	SH / H / L	%	79 / 79 / 82	77 / 77 / 78
	Enthalpy Exchange Efficiency	Heating (SH / H / L) %		72 / 72 / 74	70 / 70 / 72
		Cooling (SH / H / L) %		63 / 63 / 66	59 / 59 / 63
	Noise Level (Sound Level, 1.5m)	SH / H / L	dB(A)	40 / 37 / 31	41 / 38 / 32
Bypass Mode	Step	SUPER-HIGH / HIGH / LOW			
	Current	SH / H / L	Amps	2.77 / 2.16 / 1.44	3.41 / 2.90 / 1.76
	Power Input	SH / H / L	W	390 / 280 / 187	480 / 385 / 210
	Air Flow	SH / H / L	CMH (CFM)	800 / 800 / 660 (471 / 471 / 388)	1,000 / 1,000 / 800 (589 / 589 / 471)
	External Static Pressure	SH / H / L	Pa (inWTR)	200 / 110 / 60 (0.80 / 0.44 / 0.24)	160 / 90 / 50 (0.64 / 0.36 / 0.20)
Heat Exchanger	Type	Air to air cross flow heat exchange			
Net Weight	kg	62	140		
Dimension	W x H x D	mm	1,062 x 365 x 1,140	1,313 x 738 x 1,140	
Duct Work*	Qty	EA	4	4 + 2	
	Size (Ø)	mm	Ø250	Ø250 + Ø350	
Supply Air Fan	Qty	EA	1	2	
	Type	-	Direct-Drive (Sirocco Fan)		
Exhaust Air Fan	Qty	EA	1	2	
	Type	-	Direct-Drive (Sirocco Fan)		
Filters (Default)	Qty	EA	2	4	
	Type	-	Cleanable fibrous fleeces		
Filters (Optional)	Size (W x H x D)	mm	1,056 x 6 x 212.5		
	Model	-	AHFT100H0		
	Qty	EA	2	4	
	Type	-	F7		
Dry Contact		PDRYCB000			

- Note : 1. ERV mode : Total Heat Recovery Ventilation mode
 2. * : Refer to dimensional drawings.
 3. Noise level : - The operating conditions are assumed to be standard.
 - Sound measured at 1.5m below the center the body.
 - Sound level will vary depending on a range of factors such as the construction(Acoustic absorption coefficient) of particular room in which the equipment is installed.
 - The sound level at the air discharge port is about 8 dB(A) higher than the unit's operating sound.
 4. Temperature and Enthalpy Exchange Efficiency at cooling Indoor Temperature : 26.5°C DB, 64.5% RH, Outdoor Temperature : 34.5°C DB, 75% RH
 5. Temperature and Enthalpy Exchange Efficiency at heating Indoor Temperature : 20.5°C DB, 59.5% RH, Outdoor Temperature : 5°C DB, 65% RH
 6. Temperature Exchange efficiency is tested at heating condition.
 7. F7 Filter is 2 pieces in 1 filter package.

Premium	Standard III	Standard II	CO ₂ Sensor
PREMTA000 PREMTA000A PREMTA000B	PREMTB100	PREMTBB10	AHCS100H0 (Internal Type : Default)
PREMTBB01	PREMTB001		

ERV

LZ-H025GBA4



Ventilation

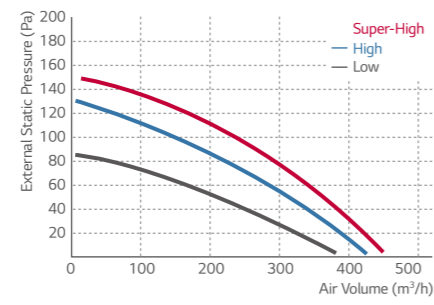

Efficiency

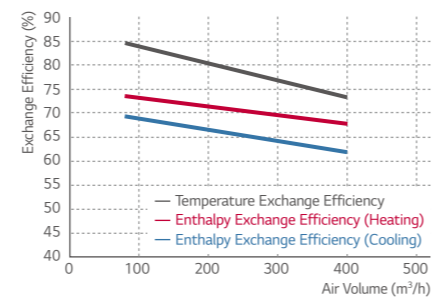

LZ-H100GBA4



Ventilation

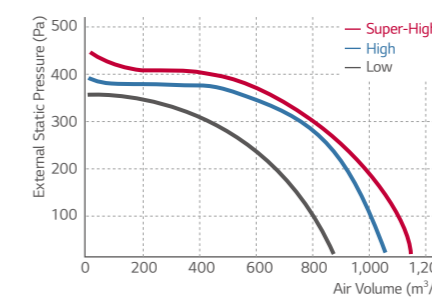

Efficiency

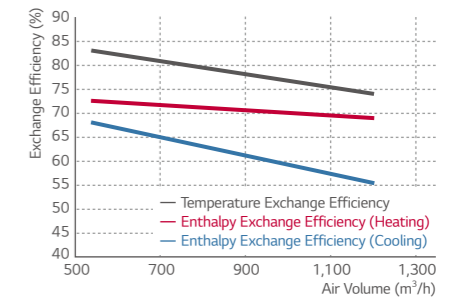

LZ-H035GBA4



Ventilation

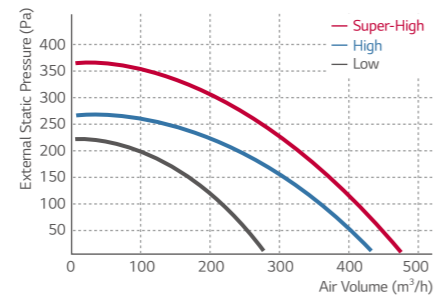

Efficiency

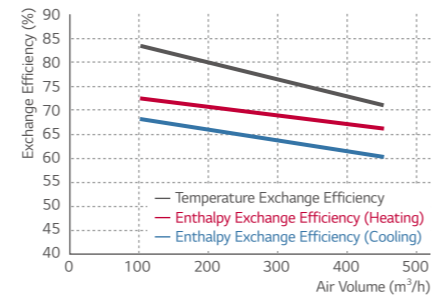

LZ-H150GBA4



Ventilation

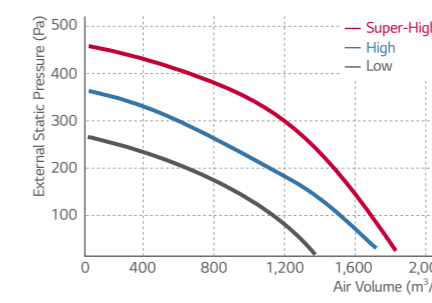

Efficiency

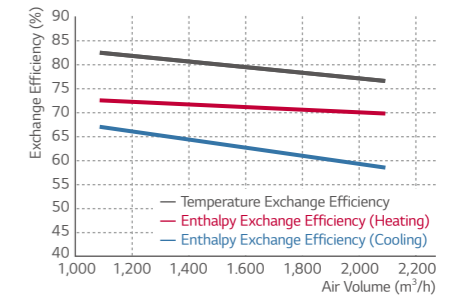

LZ-H050GBA4



Ventilation

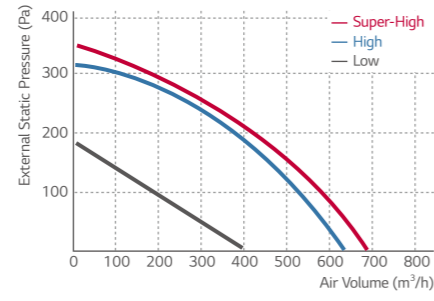

Efficiency

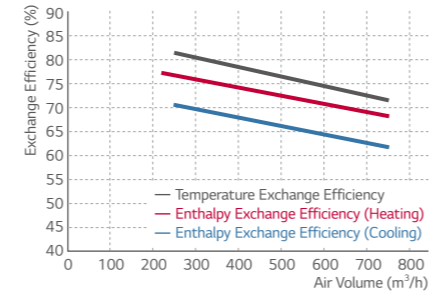

LZ-H200GBA4



Ventilation

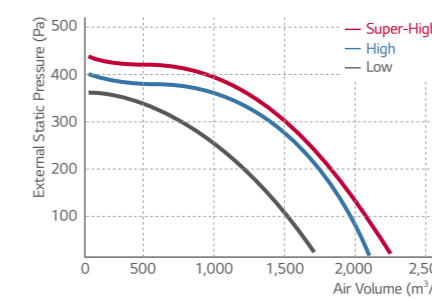

Efficiency

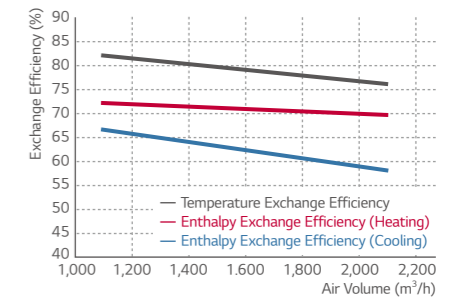

LZ-H080GBA4



Ventilation

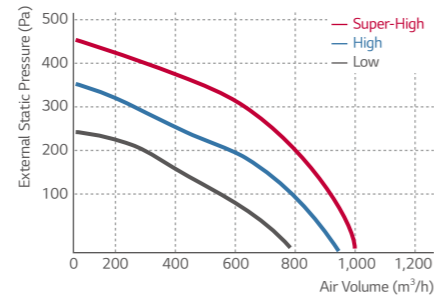

Efficiency

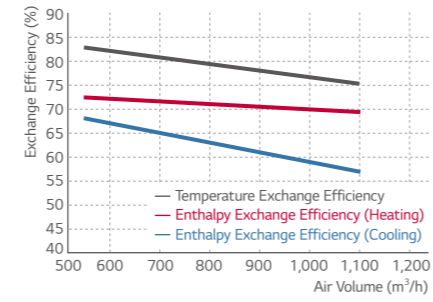

ERV WITH DX COIL

Providing Cool & Warm Fresh Air

During the summer, ERV DX can transform outdoor warm air into cool air for indoors, and it can prevent cold drafts during the winter by supplying warm air.

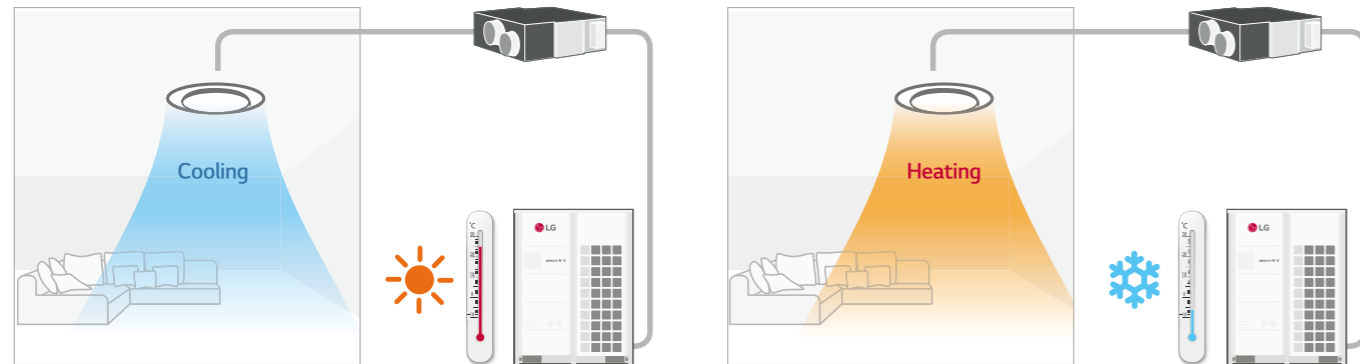

Total Air Conditioning Solution

LG ERV DX can be used as a Total Air Conditioning Solution. It can control condition of incoming air with the DX coil and humidifier for making comfortable indoor air. In the summer, LG ERV DX controls the air indoors by cooling and dehumidifying incoming air. In winter, it can provide warm air by heating and humidifying the incoming air.

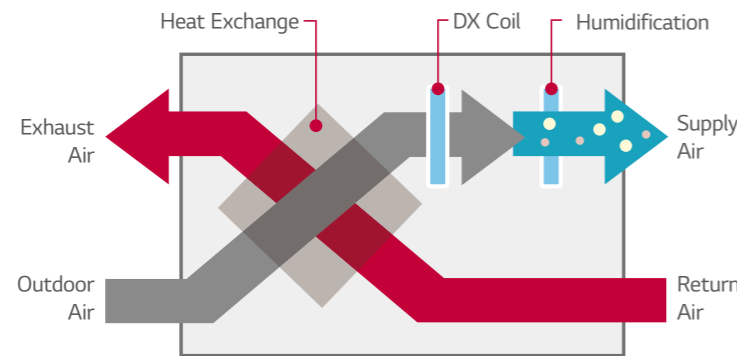

Interlocking with MULTI V

LG ERV DX can be interlocked with MULTI V. It can be controlled individually by a wired remote controller connected to MULTI V indoor units.

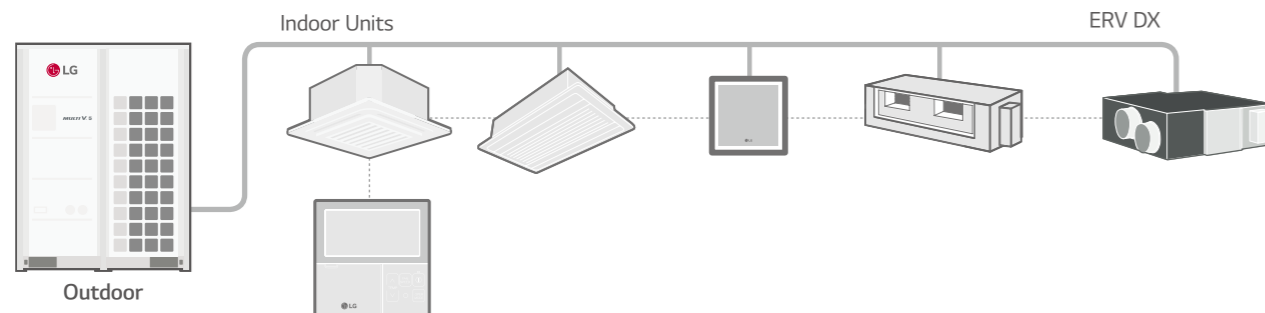

ERV WITH DX COIL

LZ-H050GXH4 / LZ-H080GXH4 / LZ-H100GXH4
LZ-H050GXN4 / LZ-H080GXN4 / LZ-H100GXN4



Model		LZ-H050GXH4	LZ-H080GXH4	LZ-H100GXH4	LZ-H050GXN4	LZ-H080GXN4	LZ-H100GXN4			
Fresh Air Conditioning Load	Cooling	kW	4.93	7.46	9.12	4.93	7.46	9.12		
	Heating	kW	6.73	9.80	11.72	6.73	9.80	11.72		
Temperature Exchange Efficiency	SH / H / L		%	86 / 86 / 87	80 / 80 / 81	76 / 76 / 78	86 / 86 / 87	80 / 80 / 81	76 / 76 / 78	
	Cooling (SH / H / L)		%	61 / 61 / 63	50 / 50 / 53	45 / 45 / 50	61 / 61 / 63	50 / 50 / 53	45 / 45 / 50	
	Heating (SH / H / L)		%	76 / 76 / 77	67 / 67 / 69	64 / 64 / 66	76 / 76 / 77	67 / 67 / 69	64 / 64 / 66	
Operation Range	Outdoor air Temperature		°C	-15 - 45	-15 - 45	-15 - 45	-15 - 45	-15 - 45	-15 - 45	
	Heat Exchange Mode (SH / H / L)		CMH	500 / 500 / 440	800 / 800 / 640	1,000 / 1,000 / 820	500 / 500 / 440	800 / 800 / 640	1,000 / 1,000 / 820	
Air Flow Rate	Bypass Mode (SH / H / L)		CMH	500 / 500 / 440	800 / 800 / 640	1,000 / 1,000 / 820	500 / 500 / 440	800 / 800 / 640	1,000 / 1,000 / 820	
	External Static Pressure (SH / H / L)		Pa	160 / 120 / 100	140 / 90 / 70	110 / 70 / 60	180 / 150 / 110	170 / 120 / 80	150 / 100 / 70	
Fan	System		Natural Evaporating Type							
	Amount		kg/h	2.70	4.00	5.40				
	Pressure Feed Water		Mpa	0.02 - 0.49						
Sound Pressure	Heat Exchange Mode (SH / H / L)		dB(A)	38 / 36 / 33	39 / 37 / 34	40 / 38 / 35	39 / 37 / 35	41 / 38 / 36	41 / 39 / 36	
	Bypass Mode (SH / H / L)		dB(A)	39 / 37 / 34	40 / 38 / 35	40 / 38 / 35	39 / 37 / 35	41 / 38 / 36	41 / 39 / 36	
Refrigerant		R410A								
Power Supply		∅, V, Hz	1, 220 - 240, 50 / 60							
Power Input (Nominal)	Heat Exchange Mode (SH / H / L)		kW	0.25 / 0.20 / 0.15	0.42 / 0.35 / 0.25	0.48 / 0.42 / 0.27	0.25 / 0.20 / 0.15	0.42 / 0.35 / 0.25	0.48 / 0.42 / 0.27	
	Bypass Mode (SH / H / L)		kW	0.25 / 0.20 / 0.15	0.42 / 0.35 / 0.25	0.48 / 0.42 / 0.27	0.25 / 0.20 / 0.15	0.42 / 0.35 / 0.25	0.48 / 0.42 / 0.27	
Nominal Running Current (RLA)	Heat Exchange Mode (SH / H / L)		A	1.5 / 1.3 / 1.0	2.5 / 2.0 / 1.5	3.6 / 3.2 / 2.3	1.5 / 1.3 / 1.0	2.5 / 2.0 / 1.5	3.6 / 3.2 / 2.3	
	Bypass Mode (SH / H / L)		A	1.5 / 1.3 / 1.0	2.5 / 2.0 / 1.5	3.6 / 3.2 / 2.3	1.5 / 1.3 / 1.0	2.5 / 2.0 / 1.5	3.6 / 3.2 / 2.3	
Heat exchange system		Air to air cross flow total heat (sensible + latent heat) exchange			Air to air cross flow total heat (sensible + latent heat) exchange					
Heat exchange element		Specially processed non-flammable paper			Specially processed non-flammable paper					
Air Filter		Multidirectional fibrous fleeces			Multidirectional fibrous fleeces					
Dimensions		W x H x D	mm	1,667 x 365 x 1,140			1,667 x 365 x 1,140			
Net Weight			kg	105			98			
Piping Connection		Liquid		mm	∅6.35			∅6.35		
		Gas		mm	∅12.7			∅12.7		
		Water		mm	∅6.35			-		
Drain Pipe (Internal Dia.)		mm (inch)	∅25 (1)			∅25 (1)				
Connection Duct Diameter		mm	∅250							

- Note : 1. Cooling Capacity Test condition - Indoor temperature : 27°C DB, 19°C WB / Outdoor temperature : 35°C DB
- 2. Heating Capacity Test condition - Indoor temperature : 20°C DB / Outdoor temperature : 7°C DB, 6°C WB
- 3. Humidifying capacity is based on the following conditions - Indoor temperature : 20°C DB, 15°C WB / Outdoor temperature : 7°C DB, 6°C WB
- 4. Cooling and heating capacities are based on the following conditions. : Fan is based on High and Super-high.
- 5. The operating sound measured at the point 1.5 m below the center of the unit is converted to that measured at an anechoic chamber.
- 6. The specifications, designs and information here are subject to change without notice.

Accessories

Chassis	LZ-H050GXH4	LZ-H080GXH4	LZ-H100GXH4	LZ-H050GXN4	LZ-H080GXN4	LZ-H100GXN4
Drain Pump	-	-	-	-	-	-
Cassette Cover	-	-	-	-	-	-
Refrigerant Leakage Detector	-	-	-	PRLDNV50	-	-
EEV Kit	-	-	-	-	-	-
Independent Power Module	-	-	-	-	-	-
Robot Cleaner	-	-	-	-	-	-
Pre Filter (Washable / Anti-fungus)	-	-	-	-	-	-
Ion Generator	-	-	-	-	-	-
CO ₂ Sensor	-	-	-	AHCS100H0	-	-
Ventilation Kit	-	-	-	-	-	-
IR Receiver	-	-	-	-	-	-
Zone Controller	-	-	-	-	-	-
Dry Contact (with Additional Accessory)	-	-	-	PDRYCB000 (1 point contact)	PDRYCB500 (Modbus)	-
External Input (1 point)	-	-	-	○	-	-
Wi-Fi	-	-	-	-	-	-

※ ○ : Applied, - : Not applied
Option : Refer to model name in table



















CONTROL SOLUTIONS

- INDIVIDUAL CONTROL
- CENTRALIZED CONTROL























- INTEGRATION DEVICE



LG HVAC CONTROL LINE-UP

INDIVIDUAL CONTROL		CENTRALIZED CONTROL			
Wired Remote Controller		Wireless Remote Controller	Display	Platform	Gateway
Standard	Simple				
<p>Standard III (White)</p>  <p>PREMTB100</p>	 <p>PQRCVCLQW</p>	<p>NEW PWLSSB21H (H/P) NEW PWLSSB21C (C/O)</p>	<p>AC Ez</p>  <p>PQCSZ250S0 (Indoor Unit -32)</p>	<p>ACP 5</p>  <p>PACP5A000 (Indoor Unit ~256) BACnet IP/Modbus TCP Gateway</p>	<p>ACP LonWorks</p>  <p>PLNWK000 (Indoor Unit -64)</p>
		<p>Wi-Fi Controller</p>			
		<p>LG Wi-Fi Modem</p>  <p>For Indoor Unit PWFMD200</p>	<p>AC Ez Touch</p>  <p>PACEZA000 (Indoor Unit -64)</p>	<p>AC Manager 5</p>  <p>PACM5A000 (Indoor Unit -8,192)</p>	<p>Modbus RTU Gateway</p>  <p>PMBUS00A</p>
<p>Standard III (Black)</p>  <p>PREMTBB10</p>	 <p>PQRCVCLQ</p>				
<p>Standard II (White)</p>  <p>PREMTB001</p>	 <p>PQRCHCAQW (Simple for Hotel)</p>		<p>AC Smart 5</p>  <p>PACSSA000 (Indoor Unit -128) BACnet IP/Modbus TCP Gateway</p>		<p>PI-485</p>  <p>For Indoor Unit (ERV) PHNFP14A0</p>
<p>Standard II (Black)</p>  <p>PREMTBB01</p>	 <p>PQRCHCA0Q (Simple for Hotel)</p>				
<p>Premium</p>					
 <p>PREMTA000 PREMTA000A PREMTA000B</p>					

Note
1. AC Smart 5 & ACP 5 provides BACnet IP / Modbus TCP. 2. KNX Gateway is provided by INTESIS.

CENTRALIZED CONTROL	INTEGRATION DEVICE			
Facility Integrator	Indoor Units		Outdoor Units	AHU Kit
	Dry Contact	Control Accessory		
<p>PDI (Power Distribution Indicator)</p>  <p>Premium (8 port) PQNUD1S40 Standard (2 port) PPWRDB000</p>	 <p>Simple Dry Contact PDRYCB000</p>	<p>Group Control Wire</p>  <p>PZCWRCG3</p>	<p>IO Module (Input / Output Module)</p>  <p>For MULTI V 5 PVDSMN000</p>	<p>Communication Kit</p>  <p>Return / Room Air control PAHCMR000</p>
<p>ACS IO Module (Input / Output Module)</p>  <p>PEXPMB000</p>	 <p>Dry Contact for Thermostat PDRYCB300</p>	<p>Remote Temperature Sensor</p>  <p>PQRSTA0</p>	<p>Variable Water Flow Control kit</p>  <p>For MULTI V WATER IV PWFCKN000</p>	<p>Discharge / Supply Air control PAHCMS000</p>
<p>Chiller Option Kit</p>  <p>PCHLLN000</p>	 <p>Dry contact for Thermostat (For using universal input) NEW PDRYCB320</p>	<p>Low Profile Remote Temperature Button Sensor</p>  <p>ZRTBS01</p>	<p>Low Ambient Kit</p>  <p>For MULTI V IV, 5 PRVC2</p>	<p>Controller Module</p>  <p>Main Module NEW PAHCM000</p>
<p>ACU IO Module</p>  <p>UIO PEXPMB300</p>	 <p>2 Points Dry Contact (For Setback) PDRYCB400</p>	<p>Zone Controller</p>  <p>4 Zones by thermostat ABZCA</p>	<p>Cool / Heat Selector</p>  <p>PRDSBM</p>	<p>Communication Module</p>  <p>NEW PAHCMC000</p>
<p>UO PEXPMB200</p>	 <p>For Modbus PDRYCB500</p>		<p>Water Communication Module</p>  <p>NEW PAHCMW000</p>	<p>Control kit</p>  <p>NEW PAHCNM000 (Max. 3 Outdoor Units)</p>
<p>UI PEXPMB100</p>				<p>EEV Kit</p>  <p>PRLK048A0 (- 28 kW) PRLK096A0 (- 56 kW)</p>
				<p>NEW PRLK396A0 (- 112 kW)</p>
				<p>NEW PRLK594A0 (- 168 kW)</p>

LG CONTROL SOLUTIONS







MULTI V 5 offers a diverse range of effective control solutions that satisfy specific needs of each building and its user scene. These controlling systems are equipped with user friendly interface, flexible interlocking environment, energy management and smart individual controller for optimized controlling conditions and smart building management.



INDIVIDUAL CONTROL



Feature Functions

Controller Name	Wired Remote Controller					Wireless Remote Controller	Wi-Fi Controller
	Premium	Standard III	Standard II	Simple	Simple(Hotel)		
Model Name							
	PREMTA000 PREMTA000A PREMTA000B	PREMTB100 PREMTBB10	PREMTB001 PREMTBB01	PQRCVCL0Q PQRCVCL0QW	PQRCHCA0Q PQRCHCA0QW	NEW PWLSSB21H (H/P) PWLSSB21C (C/O)	PWFMD200
Basic	On / Off	○	○	○	○	○	○
	Fan Speed Control	○	○	○	○	○	○
	Temperature Setting	○	○	○	○	○	○
	Mode Change	○	○	○	○	-	○
	Auto Swing	○	○	○	○	○	○
	Vane Control (Louver Angle)	○	○	○	○	○	○
	E.S.P (External Static Pressure)	○	○	○	○	○	-
	Electric Failure Compensation	○	○	○	○	○	-
Advanced	Indoor Temperature Display	○	○	○	○	○	○
	ALL Button Lock (Child Lock)	○	○	○	○	○	-
	Schedule / Timer	Weekly-Yearly	Weekly-Yearly	Weekly	-	-	Sleep / On / Off
	Additional Mode Setting ¹⁾	○	○	○	-	-	-
	Time Display	○	○	○	-	-	○
	Humid. Display	○	○	-	-	-	-
	Advanced Lock (Mode, Set point, Set point range, On / Off Lock)	Advanced Lock	Advanced Lock	-	-	-	-
	Filter Sign	○	○	○	-	-	-
ETC	Energy Management ²⁾	○	○	○	-	-	-
	Dual Set Point	○	○	-	-	-	-
	Human Detection	-	○	-	-	-	-
	Temp, Humidity Compensation	○	○	-	-	-	-
	Wi-Fi AP Mode Setting	○	○	○	○	○	○
	Operation Status LED	○	○	○	○	○	-
ETC	Wireless Remote Controller Receiver	○ ³⁾	-	○ ³⁾	○ ³⁾	○ ³⁾	-
	Display	5 inch Color	4.3 inch Color	4.3 inch mono	2.6 inch mono	2.6 inch mono	2 inch mono
	Size (W x H x D, mm)	137 x 121 x 16.5	120 x 120 x 16	120 x 120 x 16	64 x 120 x 15	64 x 120 x 15	51 x 153 x 26
	Black Light Control for Screen Saver	○	○	-	-	-	-

※ ○ : Applied, - : Not Applied

1) It might not be indicated or operated at the partial product.

2) Centralized control (PACEZA000 / PACS5A000 / PACP5A000 / PLNWK8000) and PDI (PQNUD1S40 / PPWRDB000) should be installed for this function.

3) For ceiling type duct

Note : 1. Indoor unit should have functions requested by the controller.

2. If you need more detail, please refer to the manual of product. (<http://partner.lge.com>: Home > Doc.Library > Manual)

INDIVIDUAL CONTROL

Standard III Wired Remote Controller

Features & Benefit

4.3 inch Color screen with a modern design.



PREMTB100 (White) PREMTBB10 (Black)

- The optimized controller for MULTI V 5
 - Humidity sensor embedded
 - Comfort cooling setting
 - Smart Load Control setting
 - Outdoor unit low noise setting
 - Defrost mode setting
- New modern design & easy interface
 - Seamless design / Touch button
 - 4.3 inch color LCD / Intuitive GUI
- Energy saving functions
 - Instantaneous power monitor
 - Energy consumption check (Power consumption, Operation time)
 - Temp. Setback timer, time limit control
 - Target setting (ODU capacity, Instantaneous power--etc)
- Group control
 - Up to 16 Indoor units can be controlled with one remote control
- External device On / Off (1 point)
 - Customized interlocking control with indoor unit is possible without dry contact
- 2 set points control
 - Increase convenience and comfort
 - Auto changeover, Setback (Home leave)

Model Name	PREMTB100 / PREMTBB10
On / Off	○
Fan Speed Control	○
Temperature Setting	○
Mode Change	Cooling / Heating / Auto / Dehumidification / Fan
Additional Mode Setting ¹⁾	Energy-Saving Cooling / Robot Cleaning / Heater / Humidification / Comfort Cooling
Auto Swing	○
Vane Control (Louver direction)	○
E.S.P (External Static Pressure) ²⁾	○
Reservation	Simple / Sleep / On & Off Timer / Weekly / Yearly / Holiday
Time Display	○
Electric Failure Compensation	○
Lock	All / On & Off / Mode / Set Temperature Range
Filter Sign	○ (Remain time + Alarm)
Energy Management	Check Energy Usage ³⁾ / Check Operation Time / Target Setting (Energy, Operation Time) / Time Limit Operation / Alarm Popup / Initialization Usage Data
Operation Status LED	○
Indoor Temperature Display	○
Indoor Humidity Display	○
Human Detection	○
Display	4.3 inch TFT color LCD (480 x 272)
Size (W x H x D, mm)	120 x 120 x 16
Black light for Screen saver	○
Home Leave	2 set points control

※ ○ : Applied, - : Not Applied
 1) It might not be indicated or operated at the partial product.
 2) This function is available for duct type.
 3) This function requires PDI (PQNUD1540 / PPWRDB000) to be installed.
 Note : 1. Indoor unit needs to have functions requested by the controller.
 2. 2 set points control works normally with MULTI V Heat Recovery and Single Split Heat Pump. But in case of MULTI V Heat Pump, It may not work properly.

Energy Saving Function

Energy Management

- Energy Monitoring & Alarm
 Real-time and day / week / month / year energy usage monitoring is possible. In addition, it can set target for energy usage and operation time, and alarm will be displayed when exceeded.
 ※ PDI (PQNUD1540 / PPWRDB000) is required.



Instantaneous Power Check

Energy Usage Target Setting

Time Limit Control

- The time-limit operation controls product by amount of time. By setting the device operation time in advance, you can control for how long a device works and have it stop automatically.



2 Set Points Control

Auto Changeover (Convenience)

- The indoor unit automatically manages room temperature with heating and cooling with extended setting temperature ranges. With setting heating and cooling set temp. just one time, comfortable condition will continue at all times.

Setback (Home Leave) (Energy saving & Comfort)

- In the absence, room temperature can be kept in the range of 2 set points instead of power off. It provides comfortable indoor environment quickly when the mode is changed to occupied.

※ This function is for Heat Recovery system or Single heat pump. Otherwise it is not guaranteed.

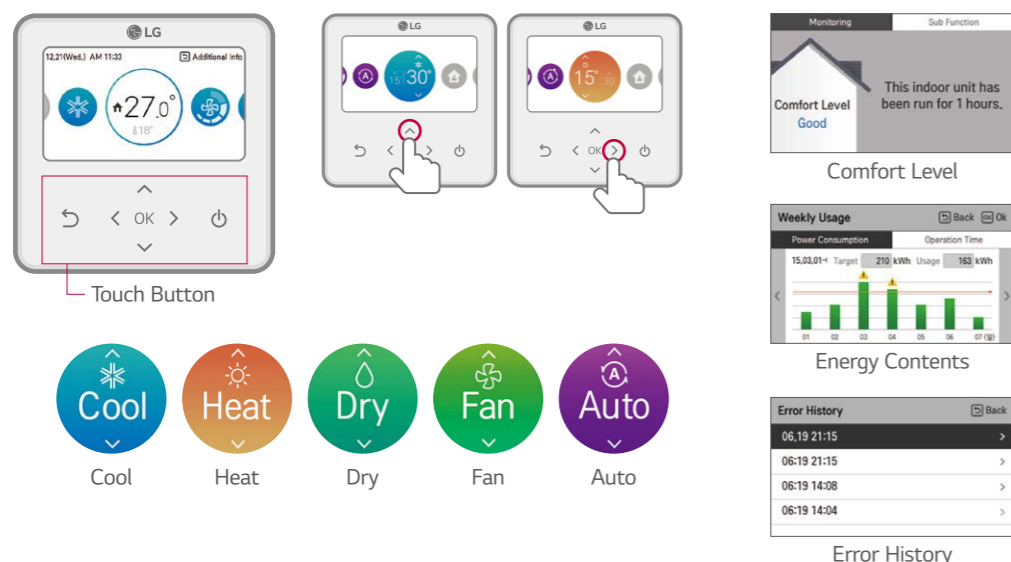
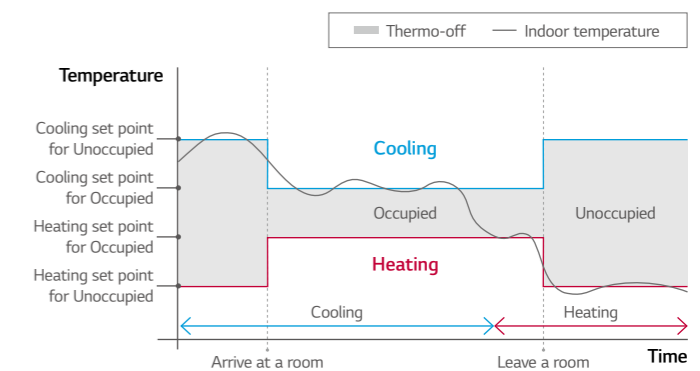

External Device On / Off

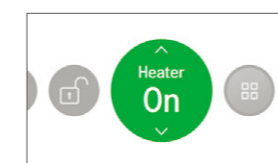

External Equipment Control
 User can turn on or off the external equipment through contact point output.

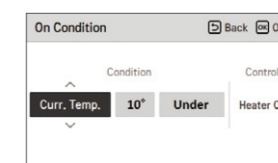

Customized Interlocking Control
 User can make control scenario. For example when temperature is under 10 degree, turn on the external heater.

Schedule Function

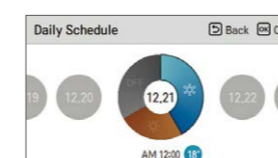

Easy Checking Schedule
 Standard III remote controller provides clock type daily schedule.

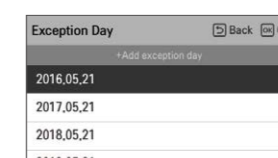

Exception Day settings
 Possible to set up exceptional date on regular schedule.

INDIVIDUAL CONTROL

Premium Wired Remote Controller

Features & Benefit

5 inch full touch screen with a premium design.



PREMTA000 ¹⁾ / PREMTA000A ²⁾ / PREMTA000B ³⁾

- 1) English / Portuguese / Spanish / French
- 2) English / Italian / Russian / Chinese
- 3) English / German / Polish / Czech

- Full Touch screen
- The Optimized Controller in MULTI V 5
 - Comfort cooling setting
 - Smart Load Control setting
 - Outdoor unit low noise setting
 - Defrost mode setting
- Design with User's Convenience
 - Intuitive GUI
 - Main display simple mode
 - 5 inch color LCD
- Energy Saving Functions
 - Instantaneous power monitor
 - Energy consumption check (Power consumption, Operation time)
 - Temp. Setback Timer, Time Limit Control
 - Target setting (ODU Capacity, Instantaneous power... etc)
- Group Control
 - Up to 16 Indoor units can be controlled with one remote control
- 2 Set Points Control
 - Increase convenience and comfort
 - Auto changeover, Setback (Home leave)

Model Name	PREMTA000 / PREMTA000A / PREMTA000B
On / Off	○
Fan Speed Control	○
Temperature Setting	○
Mode Change	Cooling / Heating / Auto / Dehumidification / Fan
Additional Mode Setting ¹⁾	Energy-Saving Cooling / Robot Cleaning / Heater / Humidification
Auto Swing	○
Vane Control (Louver direction)	○
E.S.P (External Static Pressure) ²⁾	○
Reservation	Simple / Sleep / On / Off / Weekly / Yearly / Holiday
Time Display	○
Electric Failure Compensation	○
Child Lock	○
Filter Sign	○ (Remain time + Alarm)
Energy Management	Check Energy Usage ³⁾ / Check Operation Time / Target Setting (Energy, Operation Time) / Time Limit Operation / Alarm Popup / Initialization Usage Data
Operation Status LED	○
Indoor Temperature Display	○
Wireless Remote Controller Receiver	○ ⁴⁾
Display	5 inch TFT color LCD (480 x 272)
Size (W x H x D, mm)	137 x 121 x 16.5
Black Light for Screen Saver	○
Home Leave	2 set points control

※ ○ : Applied, - : Not Applied
 1) It might not be indicated or operated at the partial product.
 2) This function is available for duct type.
 3) This function requires PDI (PQNUD1S40 / PPWRDB000) to be installed.
 4) For ceiling type ducted unit.
 Note : 1. Indoor unit needs to have functions requested by the controller.
 2. 2 set points control works normally with MULT V Heat Recovery and Single Split Heat Pump. But in case of MULTI V Heat Pump, It may not work properly.



Full Touch Screen

Easy Energy Management

- Check the operation hour or electricity usage
- Comparison of usage compared to last year
- Set the target usage and time



Easy Scheduling

- Daily, Weekly, Yearly schedule function
- Schedule pattern setting
- Schedule copy



2 Set points Control

- Auto changeover switching the operation mode automatically
- Setback (Home Leave) Changing status by occupied / unoccupied
- ※ This function is only for Heat Recovery system and Single heat pump.

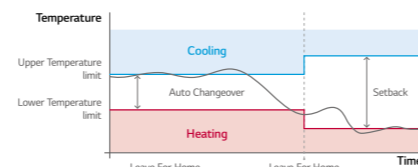

Group Control

- Max. 16 Indoor units by one remote controller.

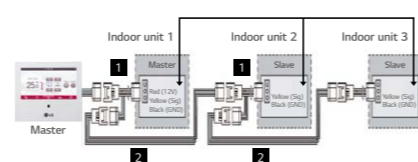

Standard II Wired Remote Controller

Features & Benefit

Providing easy control of one or a group of indoor units with various functions.



PREMTB001 (White)



PREMTBB01 (Black)

- Wired remote controller that can implement various functions such as schedule, filter sign.

Model Name	PREMTB001 / PREMTBB01
On / Off	○
Fan Speed Control	○
Temperature Setting	○
Mode Change	Cooling / Heating / Auto / Dehumidification / Fan
Additional Mode Setting	Energy-Saving Cooling / Robot Cleaning / Heater / Humidification
Auto Swing	○
Vane Control (Louver direction)	○
E.S.P (External Static Pressure)	○
Reservation	Simple / Sleep / On / Off / Weekly / Holiday
Time Display	○
Electric Failure Compensation	○
Child Lock	○
Filter Sign	○ (Remain time + Alarm)
Operation Status LED	○
Indoor Temperature Display	○
Wireless Remote Controller Receiver	○ ¹⁾
Size (W x H x D, mm)	120 x 120 x 16
Blacklight	○
Power Consumption Monitoring	○ ²⁾
Check Model Information	○

※ ○ : Applied, - : Not Applied
 1) For ceiling type ducted unit.
 2) This function requires PDI (PQNUD1S40 / PPWRDB000) to be installed.
 Note : Indoor unit needs to have functions requested by the controller.

Simple Wired Remote Controller

Features & Benefit

A simple way to control office or hotel systems in a compact design



PQRCVCLOQW (White) / PQRCVCLOQ (Black)



PQRCHCA0QW (White) / PQRCHCA0Q (Black)

- Small remote control with minimal functionality.

Model Name	PQRCVCLOQW / PQRCVCLOQ	PQRCHCA0QW / PQRCHCA0Q
On / Off	○	○
Fan Speed Control	○	○
Temperature Setting	○	○
Mode Change	Cooling / Heating / Auto / Dehumidification / Fan	-
Auto Swing	○	○
Vane Control (Louver direction)	○	○
E.S.P (External Static Pressure)	○	○
Electric Failure Compensation	○	○
Child Lock	○	○
Indoor Temperature Display	○	○
Wireless Remote Controller Receiver	○ ¹⁾	○ ¹⁾
Size (W x H x D, mm)	70 x 121 x 16	70 x 121 x 16
Blacklight	○	○

※ ○ : Applied, - : Not Applied
 1) For ceiling type ducted unit.
 Note : Indoor unit needs to have functions requested by the controller.

Wireless Remote Controller

Features & Benefit



NEW PWLSSB21H (H/P)
NEW PWLSSB21C (C/O)

- Easy to use while moving.
- Main functions are available.

Model Name	PWLSSB21H (H/P) / PWLSSB21C (C/O)
On / Off	○
Fan Speed Control	○ ¹⁾
Temperature Setting	○
Mode Change	Cooling / Heating / Auto / Dehumidification / Fan
Additional Mode Setting	Plasma Purification / Energy-Saving Cooling / Robot Cleaning / Auto Dry
Auto Swing	○
Vane Control (Louver direction)	○
Reservation	Sleep / On / Off
Time Display	○
Indoor Temperature Display	○
Sleep Mode Auto	Max. 7 hours
Size (W x H x D, mm)	51.4 x 153 x 26

※ ○ : Applied, - : Not Applied
 1) For some products, you can use "slow" fan speed function.

INDIVIDUAL CONTROL

LG Wi-Fi Modem

Features & Benefit

Control LG air conditioners via using the internet devices as Android or iOS smartphones.



PWFMD200

- Access LG air conditioner anytime and from anywhere with Wi-Fi equipped device.
- It is possible to check whether the air conditioner is turned off when the user goes out (energy saving), and can be operated in advance before entering the house (comfort improvement).
- LG's exclusive Home Appliances control app (LG ThinQ) is available.
- Simple operation for various functions
 - On / Off
 - Operation Mode
 - Current/Set Temperature
 - Fan Speed
 - Vane Control ¹⁾
 - Reservation (Sleep, Weekly On / Off)
 - Energy Monitoring ²⁾
 - Filter Management
 - Error Check

Model Name	PWFMD200
Size (W x H x D, mm)	48 x 68 x 14
Interfaceable Products	MULTI V Indoor unit ³⁾
Connection Type	Indoor unit 1:1
Communication Frequency	2.4 GHz
Wireless Standards	IEEE 802.11b/g/n
Mobile Application	LG ThinQ (Android v4.1 (Jellybean) or higher, iPhone iOS 9.0 or higher)
Optional Extension Cable	PWYREW000 (10m extension)

1) Vane Control may not be possible according to the type of Indoor unit.
 2) LG Centralized controller and PDI installation is required for this function.
 3) For the compatibility with Indoor unit, please contact regional LG office.
 Note : 1. Functionality may be different according to each IDU model.
 2. User interface of application shall be revised for its design and contents improvement.
 3. Application is optimized for smartphone use, so it may not be well functioning with tablet devices.

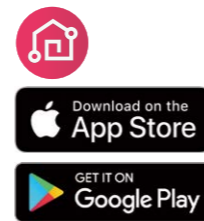

Connected Diagram

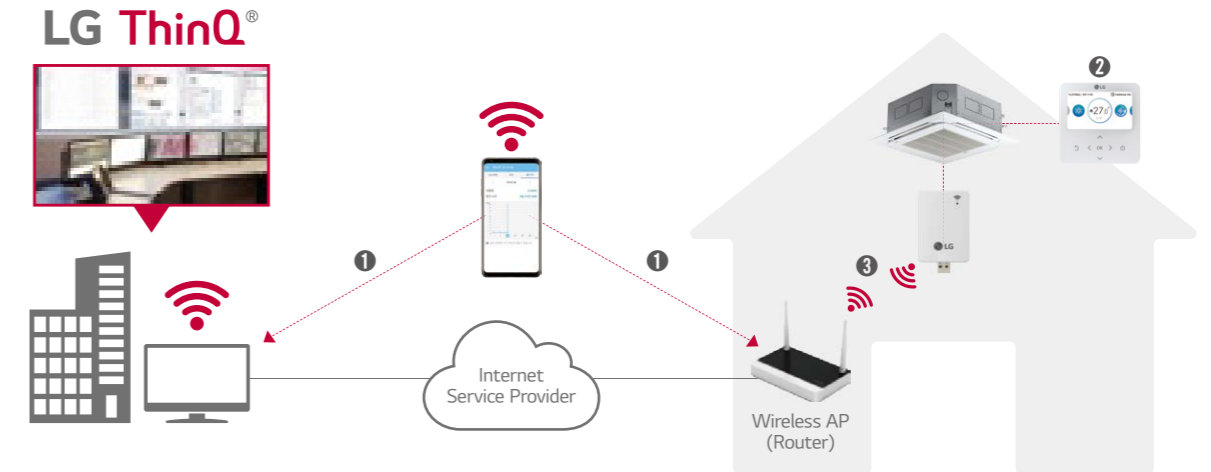

Connection (Pairing) Order

- 1) Make LG account on LG ThinQ and select the Router that will use.
- 2) Insert passwords of selected router and do set AP by LG remote controller.
- 3) Confirm the pairing between Wi-Fi Modem and Router.

Overview

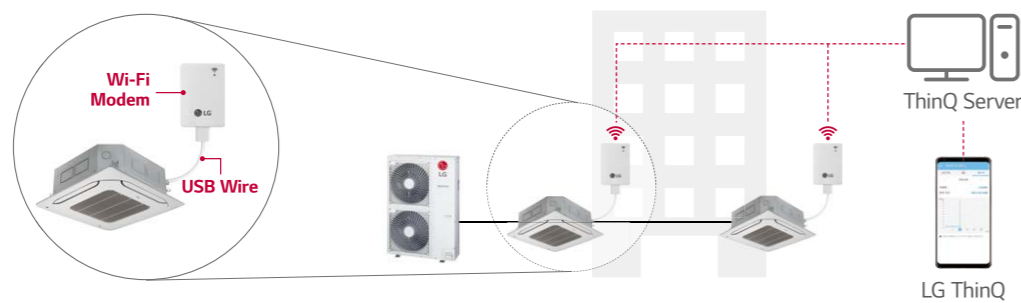

※ Search "LG ThinQ" on Google market or Appstore then download the app. ※ Internet service with Wi-Fi connection has to be available.

Installation Scene

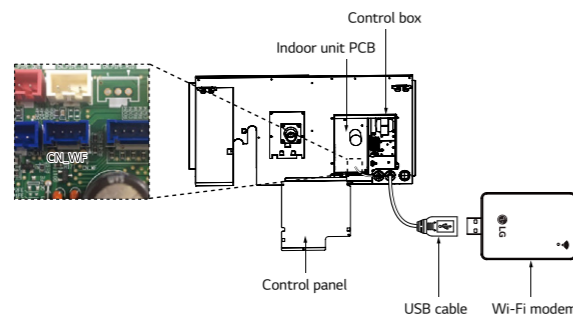

※ Each indoor unit has a Wi-Fi modem installation location inside the product, and it can be installed by exposure if necessary.

LG ThinQ

Simple operation for various functions

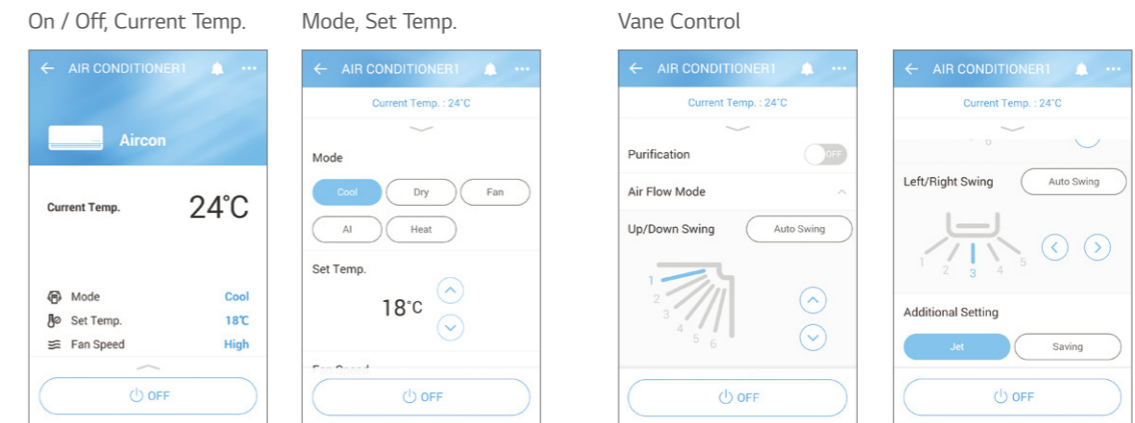



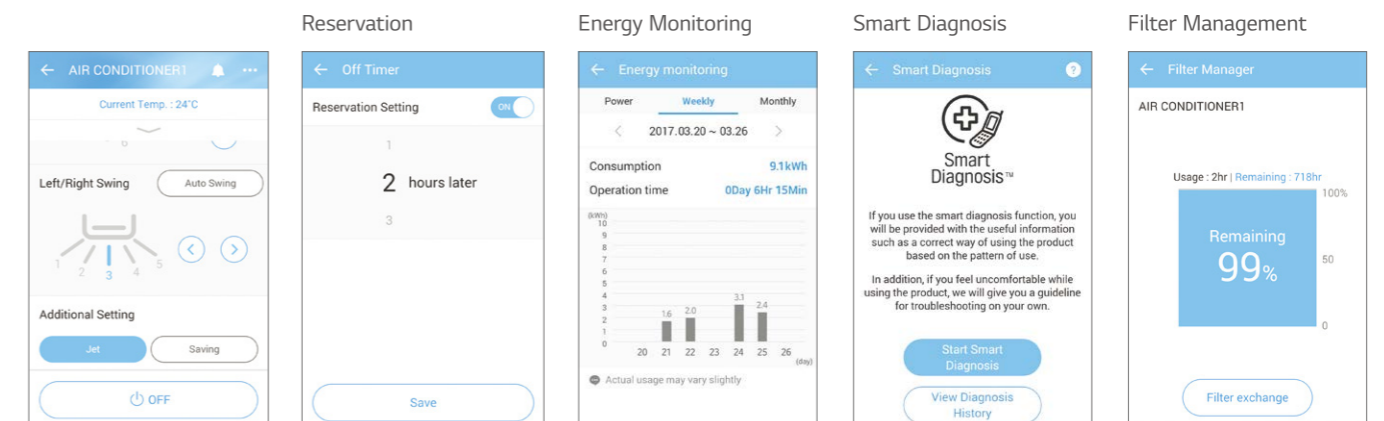

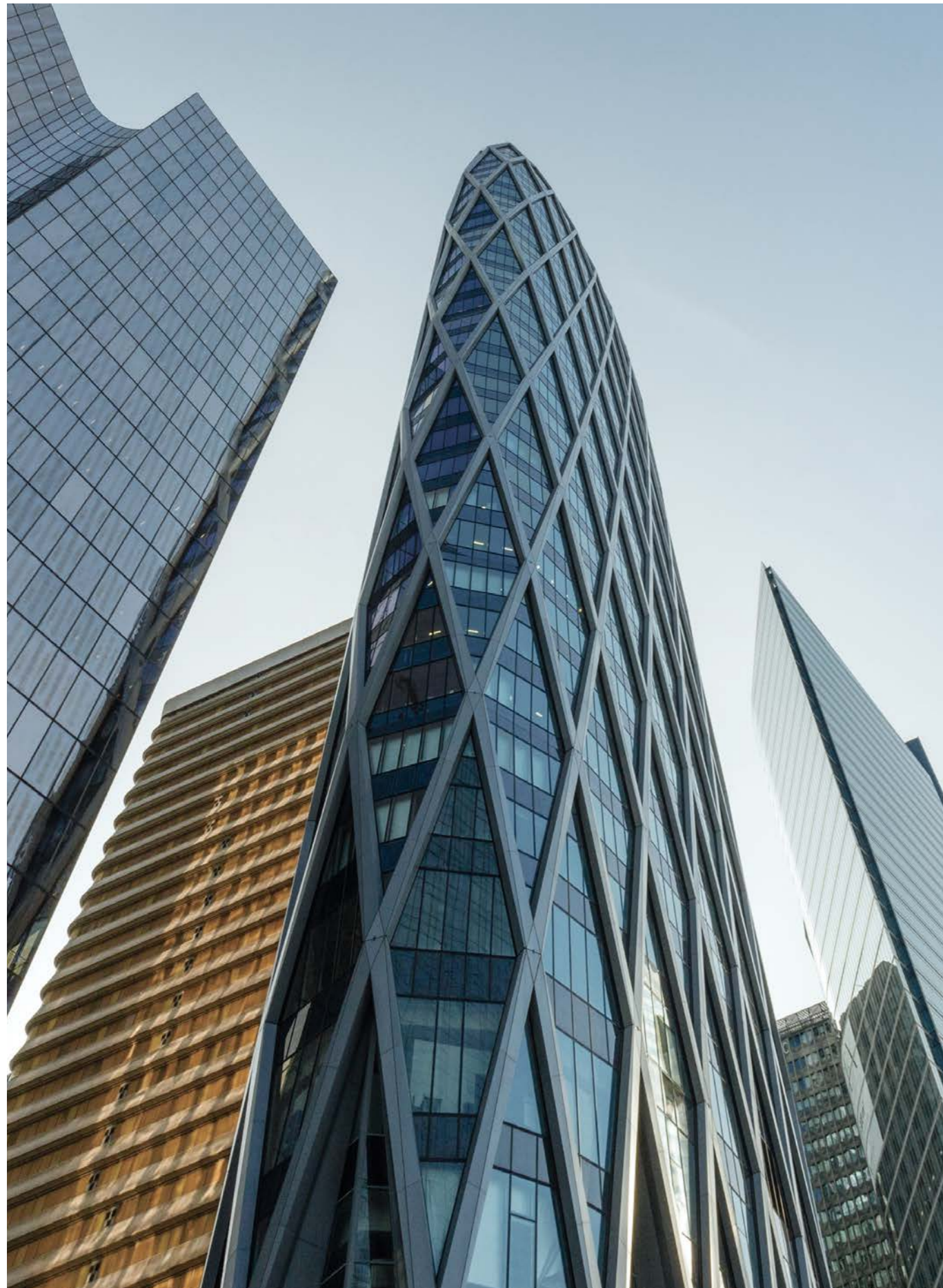

Straight forward Management



CENTRALIZED CONTROL



Centralized Controller Feature List

Controller Name		AC Ez	AC Ez Touch	AC Smart 5 ⁵⁾	ACP 5 ⁵⁾	ACP Lonworks	AC Manager 5 ³⁾
Model Name							
		PQCSZ250S0	PACEZA000	PACS5A000	PACP5A000	PLNWKB000	PACM5A000
Product	DO	-	-	2	4	2	-
	DI	-	1	2	10	2	-
	IDUs	32	64	128	256	64	8,192
	Max. Connectable No.	32	64	128	256	64	8,192
	A/C + ERV	32	64	128	256	64	8,192
	AHU	-	-	16	16	16 ⁴⁾	16 x 32
Chiller	-	-	5 Optional ²⁾	10 Optional ²⁾	-	10 x 32	
Compatibility	Air Conditioner	○ ¹⁾	○	○	○	○	○
	Ventilation (ERV / ERV DX)	○ ²⁾	○	○	○	○	○
	Heating	-	○	○	○	○	○
	AHU	-	-	○	○	○	○
	Chiller	-	-	○ ⁴⁾	○ ⁴⁾	-	○
	ACS IO	-	-	○ ⁴⁾	○ ⁴⁾	○ ⁴⁾	○
Additional Function	Add Drawing	-	-	○ ⁴⁾	○ ⁴⁾	○ ⁴⁾	○
	Group Management	-	-	○ ⁴⁾	○ ⁴⁾	○ ⁴⁾	○
	Auto Changer Over	-	○	○ ⁴⁾	○ ⁴⁾	○ ⁴⁾	○
	Set Back	-	○	○ ⁴⁾	○ ⁴⁾	○ ⁴⁾	○
	2 Set	-	○	○	○	○ ⁴⁾	○
	Change Alarm	-	Filter	Filter	Filter	Filter	Filter
	Indoor Unit Lock	-	○	○	○	○ ⁴⁾	-
	Cycle	-	-	○	○	○ ⁴⁾	○
Schedule	○	○	○ ⁴⁾	○ ⁴⁾	○ ⁴⁾	○	
Auto Control	Priority Control	-	○	○	○	○ ⁴⁾	○
	Outdoor Unit Capacity Control	-	-	○ ⁴⁾	○ ⁴⁾	○ ⁴⁾	○
	Time limit control	-	-	○ ⁴⁾	○ ⁴⁾	○ ⁴⁾	○
	InterLocking	-	-	○ ⁴⁾	○ ⁴⁾	○ ⁴⁾	○
Energy Navigation	-	-	○ ⁴⁾	○ ⁴⁾	-	○	
Energy Report	Power	-	○	○	○	○ ⁴⁾	○
	Gas	-	-	○	○	○ ⁴⁾	○
	Run time	-	-	○ ⁴⁾	○ ⁴⁾	○ ⁴⁾	○
	Email	-	-	-	-	○ ⁴⁾	-
Trend Reporting	PC / USB	-	-	○ ⁴⁾	PC	PC	PC
	History	-	-	-	-	-	○
History	Report (Control / Error)	-	Error	○ ⁴⁾	○ ⁴⁾	○ ⁴⁾	○
	Send Email	-	-	○ ⁴⁾	○ ⁴⁾	○ ⁴⁾	○
	Save to PC / USB ⁶⁾	-	-	-	-	○ ⁴⁾	-
etc	Summer Time	-	○	○ ⁴⁾	○ ⁴⁾	○ ⁴⁾	○
	Outdoor Unit Oil-Return Operation	-	-	○ ⁴⁾	○ ⁴⁾	○ ⁴⁾	-
	User Authority	-	Password	○ ⁴⁾	○ ⁴⁾	○ ⁴⁾	○
	PC Access	-	○	○ ⁴⁾	○ ⁴⁾	○ ⁴⁾	○

※ ○ : Applied, - : Not Applied
 1) Except for some feature (Individual lock, Limit, Temp., etc.)
 2) Except for some feature (User mode, Additional function, etc.)
 3) ACP 5 or AC Smart 5 is required.
 4) This function is possible to use in Web Only. (BMS Point is not applied)
 5) Without additional device, ACP 5 and AC Smart 5 provide BACnet IP and Modbus TCP interface for BMS.
 6) ACS, ACP, ACM 5 Expected to 4Q, 2020

CENTRALIZED CONTROL

AC EZ Touch

Features & Benefit

Smart management with 5 inch touch screen for small site.



PACEZA000

- Remote Access with Graphical User Access Control
- Total 200 Schedule Events
- Energy saving mode
- Energy Monitoring (with PDI)
- 2 Set point function (Upper / Lower Temperature setting)
- Temperature Set points Range Limit
- Remote Controller Lock (All, Temp, Mode, Fan Speed)
- Operation History
- Change alarm (Filter change)
- Emergency stop

Model Name	PACEZA000
Size (W x H x D, mm)	137 x 121 x 25
Interfaceable Products	MULTI V / ERV / ERV DX / HYDRO KIT / THERMA V
Maximum number of units	64
Individual / Group Control	On & Off / Mode / Temperature / Fan speed
Individual Controller Lock	Temperature / Mode / Fan speed / All
Error Check	○
Slave Mode (Interlocking with higher level controller)	○
Schedule	Weekly / Monthly / Yearly / Exception day
Remote Access	By client S/W
Emergency Stop & Alarm Display	○
Power Consumption Monitoring (with PDI)	○
Auto Changeover / Setback	○
Temperature Limit	○
Operation History	Error record
ODU Low Noise ¹⁾	○
Daylight Saving Time	○
External IO Port	DI 1
IPv6 Support	○

※ ○ : Applied, - : Not Applied
1) It is only available in some products.

Overview

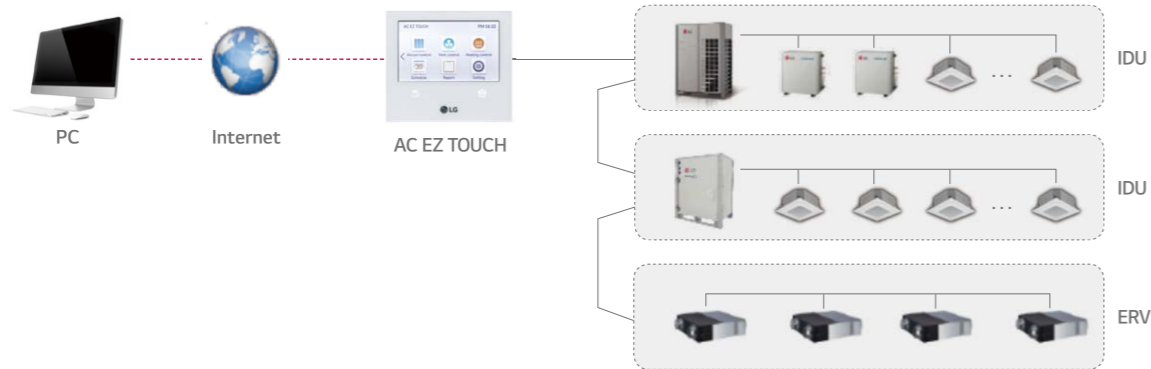

Feature

PC Access

Users can control each space efficiently through PC access.



Energy Statistics (with PDI)

Statistics of operational status (Time, Power consumption) are provided to help make intelligent system operation decisions.

Energy		
2016. 2. 8 ~ 2016. 3. 19		
	Today	Week
Name	Usage(kWh)	Accumulated(kWh)
Group1	110	3021
Group2	150	6186
Group3	130	4267
Group4	120	7614

Energy Mode

When using energy mode function, operation mode changes from cooling to fan or heating to off mode by force. (It is available only 'on' mode indoor unit)



Alarm Indicator

It works when there are some errors or it's time to change the filter. Users can respond immediately according to alarm indicator therefore HVAC system is monitored consistently.

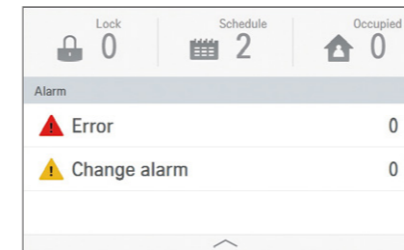

Schedule

Schedule control allows user to set the events in advance to maximize system performance. Also, by blocking unnecessary operation, it prevents a waste of energy.

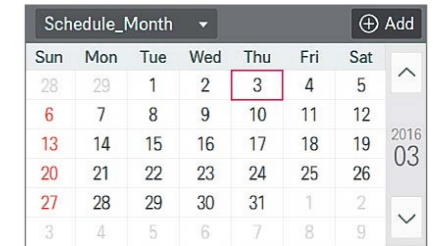

Group / Individual Control

According to the situation, it can be controlled by group or each indoor unit. It is useful to monitor or control for the best fit of request.

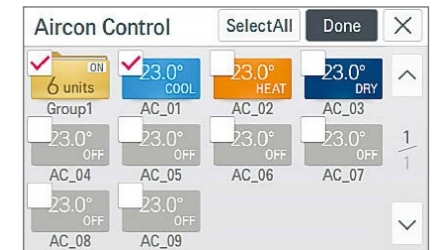

AC EZ

Features & Benefit

Easy to manage up to 32 indoor units, including ERV with simple interface.



PQCSZ250S0

- 32 indoor units control
- Weekly Schedule
- Individual / Group Control

Model Name	PQCSZ250S0
Size (W x H x D, mm)	190 x 120 x 20
Interfaceable Products	MULTI V / ERV / ERV DX
Display	LED / LCD Display
Power	DC 12V
Maximum number of units	32
Individual / Group Control	On & Off / Mode / Temperature / Fan speed
Individual Controller Lock	All
Error Check	○
Slave Mode (Interlocking with higher level controller)	○
Schedule	Weekly

※ ○ : Applied, - : Not Applied



• Appropriate PI 485 should be used according to PDB

- MULTI V S
- MULTI V WATER I
- MULTI V WATER II
- MULTI S
- MULTI SPLIT
- SINGLE SPLIT
- ERV

CENTRALIZED CONTROL

AC SMART 5

Features & Benefit

Control LG air conditioners via using the internet devices as Android or iOS bases smartphones.



PAC5A000

- The central controller allows control of the LG HVAC system to various platforms. (Touch screen, PC, Smartphone, Tablet)
 - DI : 2 / DO : 2
 - Max. 128 IDU control
 - BACnet IP / Modbus TCP
 - Schedule
 - Map View (Visual Navigation)
 - Time limit control / Auto change over
 - Energy monitoring
 - History / Operation Trend
 - Interlock with 3rd party equipment (ACS IO, ACU IO Module is needed)
 - Multi level grouping
 - Emergency stop & alarm
 - Error alarm by E-mail

Model Name	PAC5A000
Size (W x H x D, mm)	253.2 x 167.7 x 28.9
Interfaceable Products	MULTI V / ERV / ERV DX / HYDRO KIT / THERMA V / AHU kit / LG Chiller ¹⁾
Maximum number of units	128
Individual / Group Control	On & Off / Mode / Temperature / Fan speed
Individual Controller Lock	Temperature / Mode / Fan speed / All
Advanced Function Setting and Display ²⁾	Comfort Cooling / ODU Low Noise / ODU Defrost Mode / Comfort Level display / CO ₂ Level display (for ERV / ERV DX) / Night Time Free Cooling (for ERV / ERV DX)
Error Check	○
Slave Mode (Interlocking with higher level controller)	○
Schedule	Weekly / Monthly / Yearly / Exception day
Web Access	○
Emergency Stop & Alarm Display	○
Power Consumption Monitoring (with PDI)	○
Auto Changeover / Setback	○
Temperature Limit	○
Operation Time Limit	○
Visual Navigation	○
Operation Trend	○
Interlock Control	○
Virtual Group Control	○
ODU Capacity Control	○
Energy Navigation (with PDI)	○
Daylight Saving Time	○
External IO Port	DI 2 / DO 2
BMS Integration ³⁾	BACnet IP / Modbus TCP
IPv6 Support	○

※ ○ : Applied, - : Not Applied
 1) Chiller Option Kit (PCHLLN000) is required.
 2) It is only available in some products.
 3) For the detail point list, please refer to the installation manual.

Overview

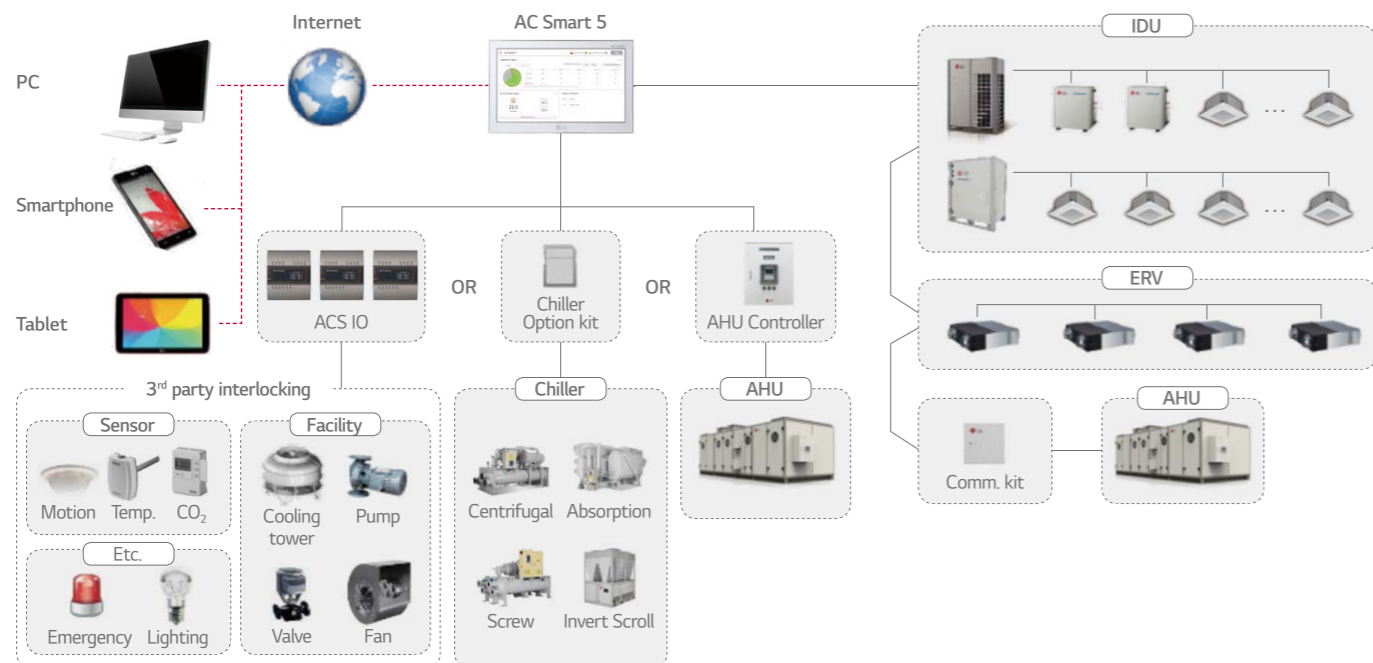

Feature

BMS Integration

Without additional device, AC Smart 5 provides BACnet IP / Modbus TCP interface for BMS (Building Management System) integration as well as its own management function.

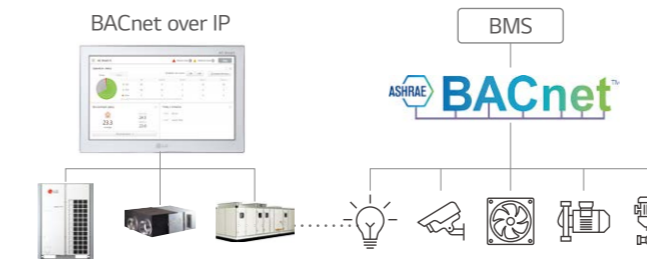

Energy Management / Operation Trend

Energy navigation function allows air conditioners operation to be managed under the monthly (Weekly / Yearly) plan of energy usage. By analyzing present energy consumption and comparing with the plan, overuse of system operational costs can be prevented.

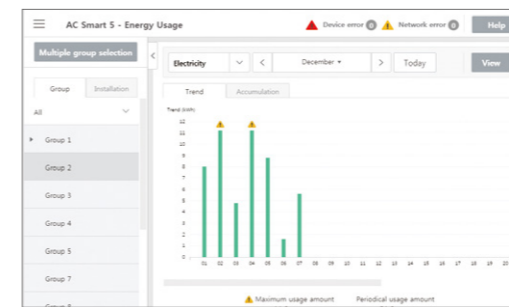

Advanced Network Accessibility

AC Smart 5 reflects the state of the art of network technology trend. IPv6 (Internet Protocol version 6), which is the most recent version of the Internet Protocol, provides accessibility to the IPv6 compatible network environment. In addition, HTML5 allows you to easily control LG HVAC system on a variety of platforms (PC, Mobile, Tablet), at any time and from any location, not just on the touch screen.



Visualized Control

Visual navigation enables controlling and monitoring the unit on floor plan view for the intuitive management.

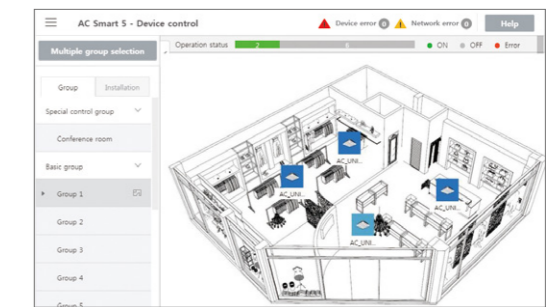

Multi Level Group Composition

You can freely apply layer structure such as building, floor, zone, etc. and set the group as the same as the site composition to control and monitor the devices. Special control group You can additionally compose frequently used groups such as VIP Room, executive room, etc. regardless of the building structure.

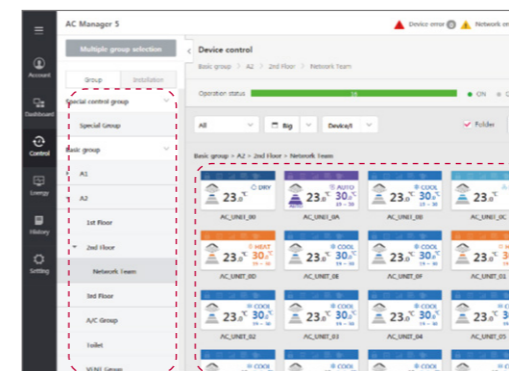

Interlocking with 3rd party equipment

AC Smart 5 can make operation scenario with 3rd party equipment by ACS IO Module. Control coverage is expanded. (Air conditioner only → Sensors, Fans, Pumps, Switches...)

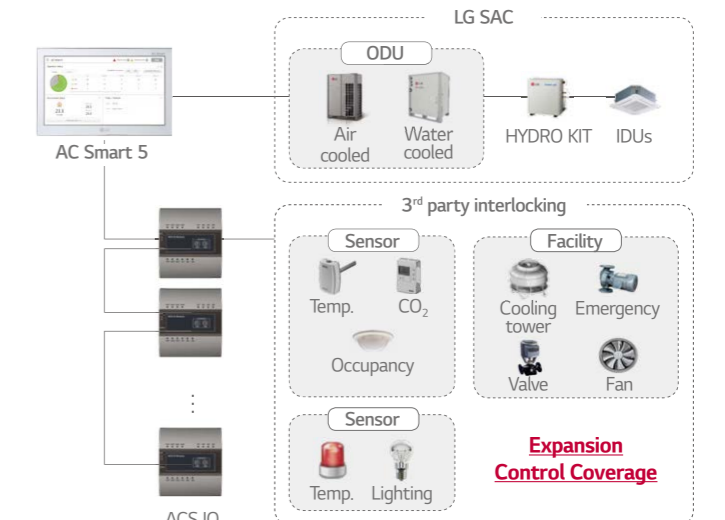

CENTRALIZED CONTROL

ACP 5

Features & Benefit

Advanced solution for BMS integration up to 256 units via BACnet and Modbus protocol as well as its own smart management function with web server interface.



PACP5A000

- The central controller allows control of the LG HVAC system to various platforms. (PC, Smartphone, Tablet)
 - DI :10 / DO : 4
 - Max. 256 IDU control
 - BACnet IP / Modbus TCP
 - Schedule
 - Map View (Visual Navigation)
 - Time limit control / Auto change over
 - Energy monitoring
 - History / Operation Trend
 - Interlock with 3rd party equipment (ACS IO, ACU IO Module is needed)
 - Multi level grouping
 - Emergency stop & alarm
 - Error alarm by E-mail

Model Name	PACP5A000
Size (W x H x D, mm)	270 x 155 x 65
Interfaceable Products	MULTI V / ERV / ERV DX / HYDRO KIT / THERMA V / AHU kit / LG Chiller ¹⁾
Maximum number of units	256
Individual / Group Control	On & Off / Mode / Temperature / Fan speed
Individual Controller Lock	Temperature / Mode / Fan speed / All
Advanced Function Setting and Display ²⁾	Comfort Cooling / ODU Low Noise / ODU Defrost Mode / Comfort Level display / CO ₂ Level display (for ERV / ERV DX) / Night Time Free Cooling (for ERV / ERV DX)
Error Check	○
Schedule	Weekly / Monthly / Yearly / Exception day
Web Access	○
Emergency Stop & Alarm Display	○
Power Consumption Monitoring (with PDI)	○
Auto Changeover / Setback	○
Temperature Limit	○
Operation Time Limit	○
Visual Navigation	○
Operation Trend	○
Interlock Control	○
Virtual Group Control	○
ODU Capacity Control	○
Energy Navigation (with PDI)	○
Daylight Saving Time	○
External IO Port	DI 10 / DO 4
BMS Integration ³⁾	BACnet IP / Modbus TCP
IPv6 Support	○

※ ○ : Applied, - : Not Applied
 1) Chiller Option Kit (PCHLLN000) is required.
 2) It is only available in some products.
 3) For the detail point list, please refer to the installation manual.

Overview

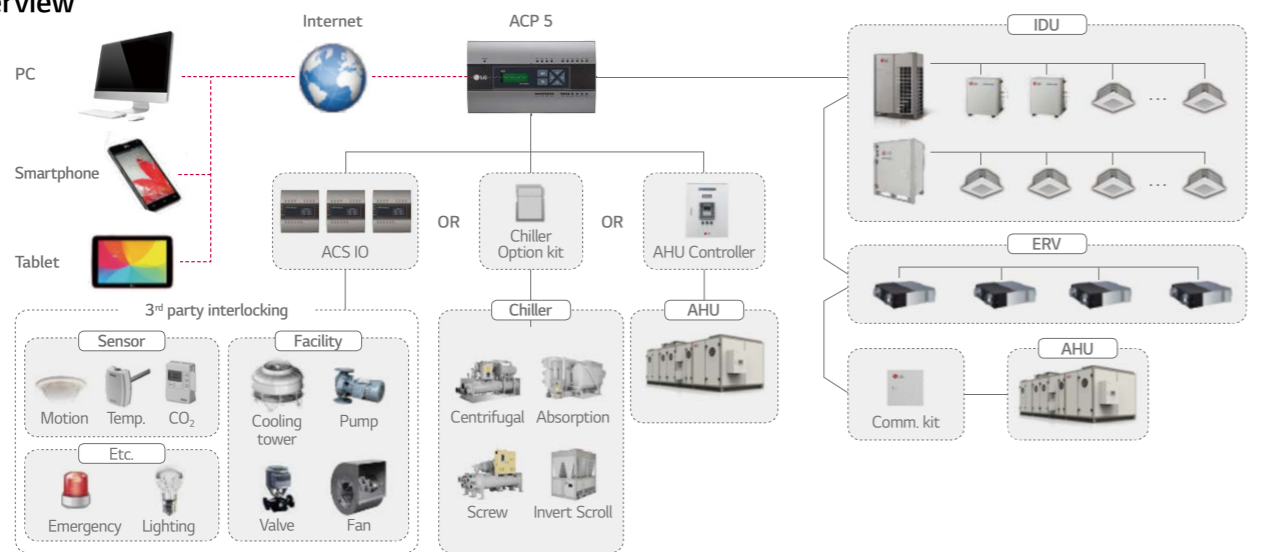

Advanced Network Accessibility



Energy Navigation

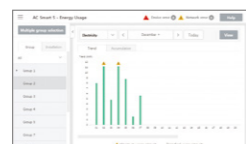

BACnet IP / Modbus TCP



Multi level group / Special control group



ACP LonWorks Gateway

Features & Benefit

LonWorks easily link LG air conditioners and other existing building systems. By including ACP control function, the controlling continues even when error occurs with BMS.



PLNWKB000

- Connect to use LonWorks[®] protocol and LG air conditioner protocol.
- Process Ability (Max. connection) : Indoor unit 64EA, AHU Control Kit : Max. 16EA
- Self installation verification using interne. (Web Server Included)
 - Diagnosis of communication status on LG Air-conditioner network.
- It offers a variety of functions as ACP which allows the customer to efficiently control various types of equipment from the customer's own Integration.

Control	Monitoring
On / Off Command	On / Off
Operation Mode Setting	Operation Mode
Lock	Lock
Temperature	Temperature
Fan Level	Fan Level
Fan Direction Auto	Fan Direction Auto
Mode Lock	Mode Lock
Fan Level Lock	Fan Level Lock
Temperature Lock	Temperature Lock
Temperature Lower Limit	Temperature Lower Limit
Temperature Higher Limit	Temperature Higher Limit
Peak Convert Cycle	Peak Convert Cycle
Peak Setting	Peak Setting
Temperature Unit	Temperature Unit
Total Temperature Lock	-
Total On / Off	-
Total Temperature	-
-	Product Type
-	Product Address
-	Current Temperature
-	Alarm
-	Power
-	Error Code
-	Peak Current Operating Percent
-	Total Accumulate Power

※ ○ : Applied, - : Not Applied

Overview

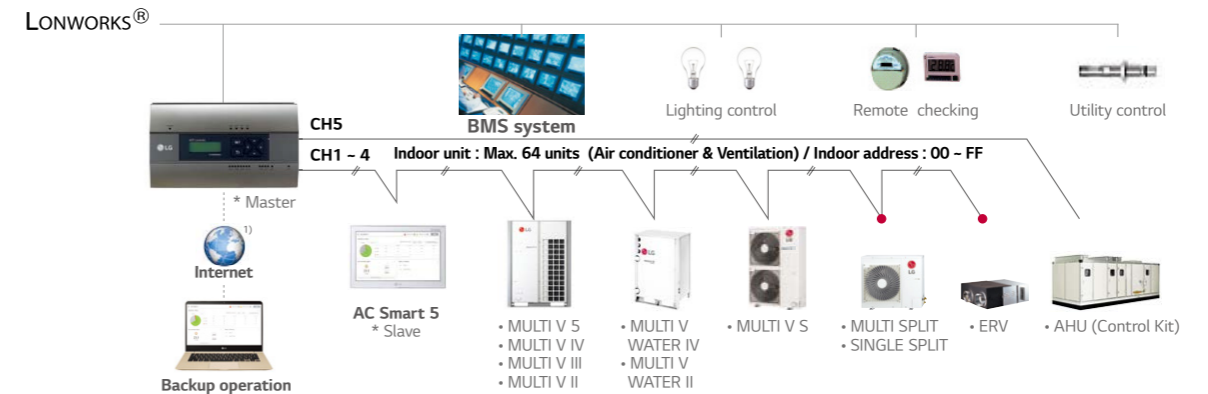

1) Assignment of public IP address is required to access central controller through internet. ● Appropriate PI 485 should be used according to PDB (Product Data Book).

PI 485

Features & Benefit

PI 485 converts LG air conditioner's protocol to the RS485 protocol for the central controller.



PHNFP14A0

- Power : Connected with the Indoor Units
- 1 for Each Indoor Unit - Indoor Unit (ERV)

CENTRALIZED CONTROL

AC Manager 5

Features & Benefit

Multiple ACP and AC Smart integration solution to manage multi sites up to 8,192 units as a single system.



PACM5A000

- Consol Type : No needs software installation and lock-key
- Max. 8,192 IDU Control
- Schedule
- Map View (Visual Navigation)
- Time limit control / Auto change over
- Energy Monitoring / Navigation
- History / Operation Trend
- Emergency stop & alarm
- Error alarm by E-mail
- Multi Language
(Eng, Ita, Spa, Por, Rus, Fra, Ger, Tur, Pol, Chi, Kor)

Model Name	PACM5A000
Size (W x H x D, mm)	270 x 155 x 65
Interfaceable Products	MULTI V / ERV / ERV DX / HYDRO KIT / THERMA V / AHU kit / LG Chiller ¹⁾
Maximum number of units	8,192 (supports 32 ACP 5 or AC Smart 5)
Individual / Group Control	On & Off / Mode / Temperature / Fan speed
Individual Controller Lock	Temperature / Mode / Fan speed / All
Error Check	○
Schedule	Weekly / Monthly / Yearly / Exception day
Web Access	○
Emergency Alarm Display	○
Power Consumption Monitoring (with PDI)	○
Auto Changeover / Setback	○
Temperature Limit	○
Operation Time Limit	○
Visual Navigation	○
Operation Trend	○
Interlock Control	○
Virtual Group Control	○
ODU Capacity Control	○
Energy Navigation (with PDI)	○

※ ○ : Applied, - : Not Applied
 1) Chiller Option Kit (PCHLLN000) is required.
 Note : AC Manager 5 requires ACP 5 or AC Smart 5.

Overview

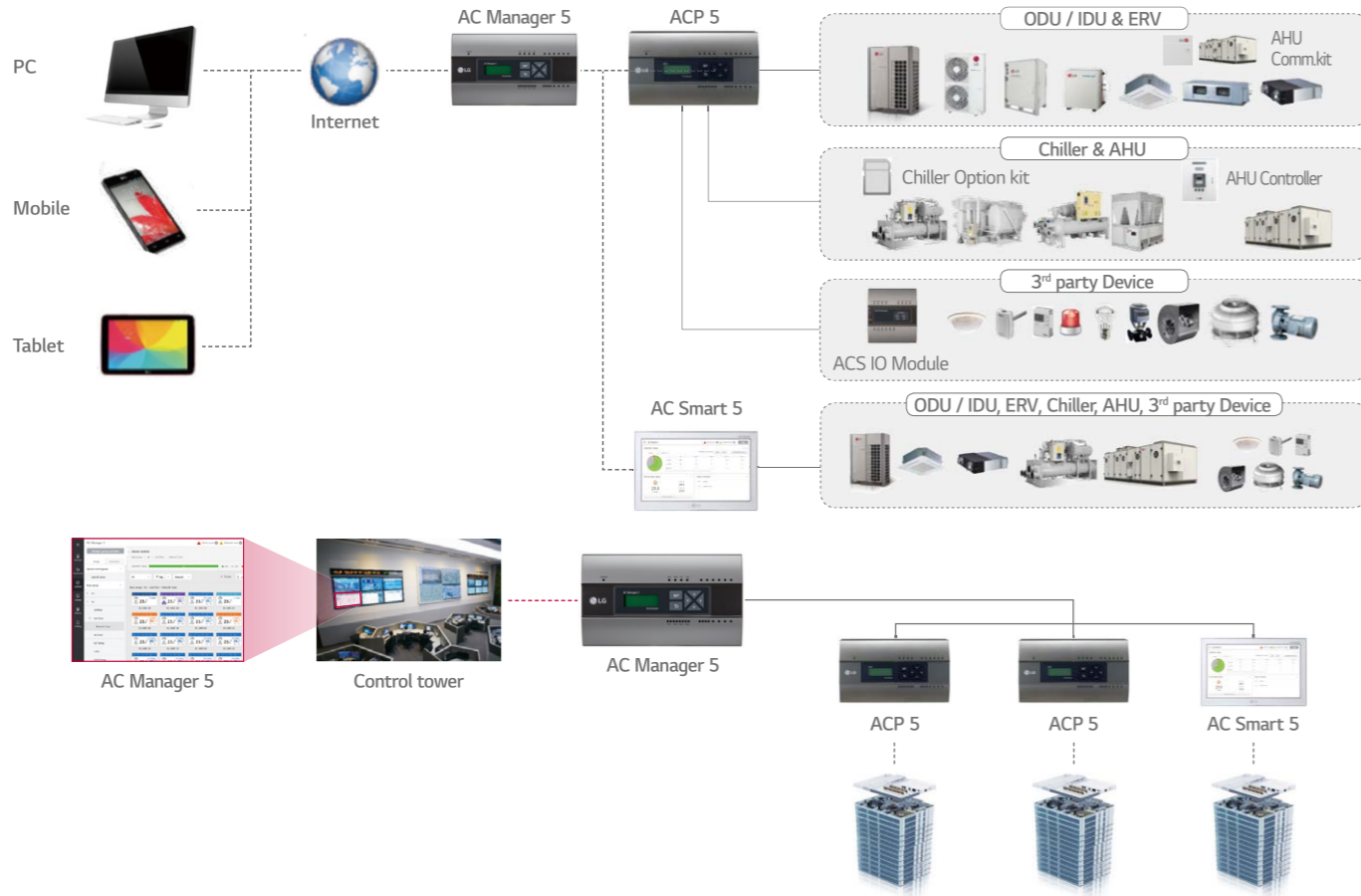

Feature

Stand-alone

Integrated with S/W program and H/W platform, it is convenient to install since users no longer need to install program with lock-key on PC.



Up to 8,192 Connections for Indoor Units

Administrators can easily and conveniently manage a variety of LG HVAC equipment. Also, it is available to manage many buildings or areas at one place via AC Manager 5.

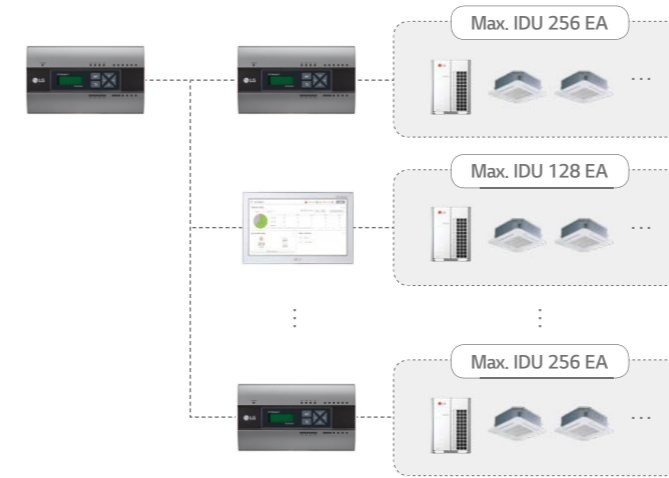

Peak Control

This function can reduce electricity use. There are two kinds of control logic. Energy saving effect by indoor unit operation rate control. Load management effect by outdoor unit capacity control.

Operation ratio (IDUs) Control



ODU Capacity Control

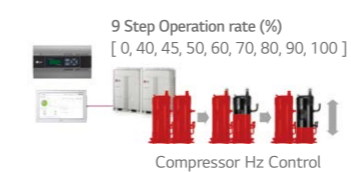

Advanced Network Accessibility & User Friendly GUI (Reddot award)

As an advanced central controller, AC Manager 5 offers flexible interface for each user by assessing the device screen and automatically customizing the layout to provide the most optimized interface.



Energy Navigation & Energy Usage Trend

Energy navigation is the function to set the target usage amount to limit the monthly power consumption and to control so that the total accumulated power consumption does not exceed the target usage amount. It performs total of 7 control levels with the estimated/actual usage amount exceeding ratio compared to the monthly target usage amount. For the control method, there are indoor unit operation ratio, outdoor unit capacity control, and indoor unit operation control.

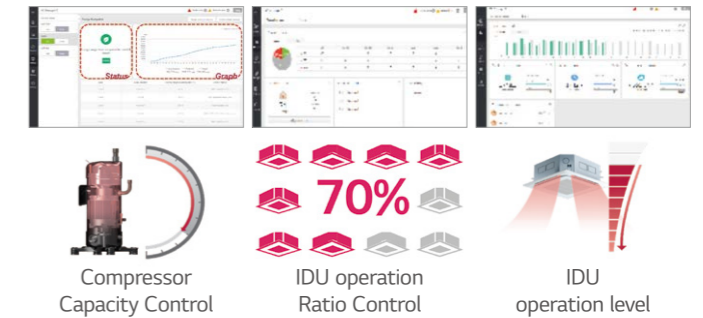

Multi Level Group Composition

You can freely apply layer structure such as building, floor, zone, etc. and set the group as the same as the site composition to control and monitor the devices. Special control group You can additionally compose frequently used groups such as VIP Room, executive room, etc. regardless of the building structure.

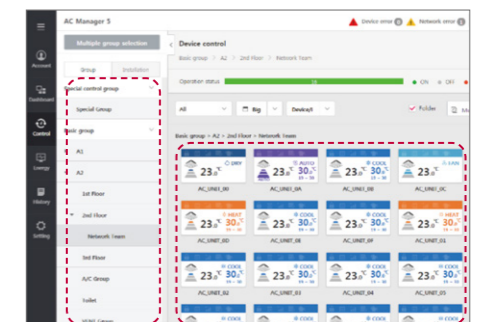

CENTRALIZED CONTROL

Modbus RTU Gateway

Features & Benefit

Providing Modbus RTU connection between LG Air conditioners and BMS.



PMBUSB00A

- Function
 - MODBUS RTU communication with MODBUS master controller
 - MODBUS RTU slave (RS485) / 9,600 bps
 - Applicable for MULTI V 5, MULTI V S, ERV, THERMA V
 - Size (W x H x D) : 53.6 x 89.7 x 60.7
 - Max.16 IDUs with single module / Max. 64 IDUs with 4 modules
 - Power : DC 12V

Modbus Gateway Memory Map

Baud Rate : 9,600 bps, Stop Bit : 1 stop bit, Parity : None Parity

Coil Register (0 x 01)

① No.	Data Bit			Function	Register
	Air Conditioner	ERV / DX ERV	HYDRO KIT & THERMA V		
1	Operate (On / Off)	Operate (On / Off)	Operate (On / Off)	0: Stop / 1: Run	Register = N x 16 + ① (N = Indoor Unit Central Address)
2	Auto Swing	Air conditioner Operate (On / Off)	Hot Water Mode (On / Off)	0: Disable / 1: Enable	
3	Filter Alarm Release	Filter Alarm Release ¹⁾	Reserved	0: Normal / 1: Alarm Release	
4	Lock Remote Controller	Lock Remote Controller	Lock Remote Controller	0: UnLock / 1: Lock	
5	Lock Operate Mode	Lock Operate Mode ¹⁾	Reserved	0: UnLock / 1: Lock	
6	Lock Fan Speed	Lock Fan Speed ¹⁾	Reserved	0: UnLock / 1: Lock	
7	Lock Target Temp.	Lock Target Temp. ¹⁾	Reserved	0: UnLock / 1: Lock	
8	Lock IDU Address	Lock IDU Address ¹⁾	Reserved	0: UnLock / 1: Lock	
9	Reserved	Quick Ventilate	Reserved	0: Disable / 1: Enable	
10	Reserved	EnergySave	Reserved	0: Disable / 1: Enable	

1) : This register value is applied 'DX Ventilator' ONLY.

Discrete Register (0 x 02)

① No.	Data Bit			Function	Register
	Air Conditioner	ERV / DX ERV	HYDRO KIT & THERMA V		
10001	Connected IDU	Connected IDU	Connected IDU	0 : Disconnected / 1: Connected	Register = N x 16 + ① (N = Indoor Unit Central Address)
10002	Alarm	Alarm	Alarm	0: Normal / 1: Alarm	
10003	Filter Alarm	Filter Alarm ¹⁾	Hot Water Only ²⁾	0 : Normal / 1: Alarm HYDRO KIT - 0 : Normal / 1: Hot Water Only	
10004	Reserved	Reserved	Target Temp. Select	0: Air / 1: Water	
10005	Reserved	Reserved	Error Division ²⁾	0 : CH type error / 1: BC type error	

1) : This register value is applied 'DX Ventilator' ONLY.
2) : This register value is applied 'HYDRO KIT' ONLY.

Holding Register (0 x 03)

① No.	Data Bit			Function	Register
	Air Conditioner	ERV / DX ERV	HYDRO KIT & THERMA V		
40001	Operate Mode	Operate Mode	Connected IDU	0 : Cooling, 1: Dehumidifying, 2 : Fan, 3 : Auto, 4: Heating HYDRO KIT (Middle Temp. DHW)/AWHP - 0 : Cooling, 3 : Auto, 4:Heating HYDRO KIT (High Temp. DHW) - 3 : Auto, 4 : Heating	Register = N x 20 + ① (N = Indoor Unit Central Address)
40002	Fan Speed	Fan Speed	Target Temp. DHW ²⁾	1 : Low, 2 : Mid, 3 : High, 4 : Auto	
40003	Target Temp.	Target Temp. ¹⁾	Target Temp. ²⁾	16.0 ~ 30.0 [°C] x 10	
40004	Target Temp. Limit (Upper)	Target Temp. Limit ¹⁾ (Upper)	Reserved	16.0 ~ 30.0 [°C] x 10	
40005	Target Temp. Limit (Lower)	Target Temp. Limit ¹⁾ (Lower)	Reserved	16.0 ~ 30.0 [°C] x 10	
40006	Reserved	Vent. Operate Mode	Reserved	0 : HEX, 1 : Auto, 2 : Normal	

1) : This register value is applied 'DX Ventilator' ONLY.
2) : This value range can be between 0 ~ 127[°C]. And it would be limited by upper & lower value according to the setting of remote controller.

Input Register (0 x 04)

① No.	Data Bit			Function	Register
	Air Conditioner	ERV / DX ERV	HYDRO KIT & THERMA V		
30001	Error Code	Error Code	Error Code	0 ~ 255 ※ Please refer to the product error table.	Register = N x 20 + ① (N = Indoor Unit Central Address)
30002	Room Temp.	RA Temp.	Room Temp.	-99.0 ~ 99.0 [°C] x 10	
30003	Pipe In Temp.	OA Temp. ¹⁾	Water Inlet Temp.	-99.0 ~ 99.0 [°C] x 10	
30004	Pipe Out Temp.	SA Temp. ¹⁾	Water Outlet Temp.	-99.0 ~ 99.0 [°C] x 10	
30005	Reserved	Pipe In Temp. ¹⁾	Sanitary Tank Temp.	-99.0 ~ 99.0 [°C] x 10	
30006	Reserved	Pipe Out Temp. ¹⁾	Solar Temp. ²⁾	-99.0 ~ 99.0 [°C] x 10	

1) : This register value is applied 'DX Ventilator' ONLY.
2) : This register value is applied 'AWHP' ONLY.

Installation Scene

- Single module
Max. 16 indoor units with a single module.

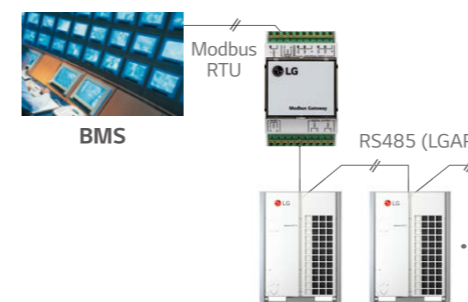

- Multiple module
Max. 64 indoor units with 4 modules in one Modbus communication line.

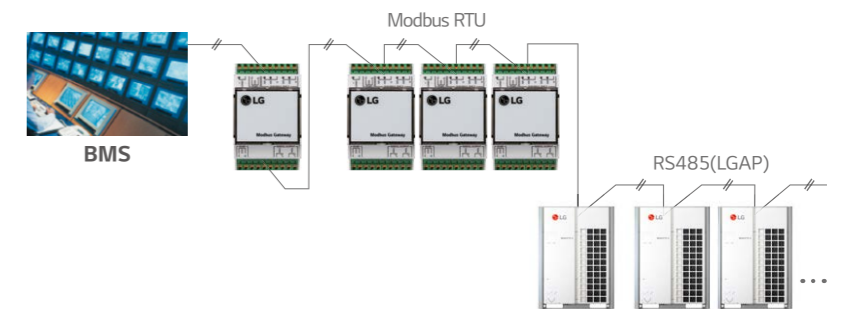

INTEGRATION DEVICE

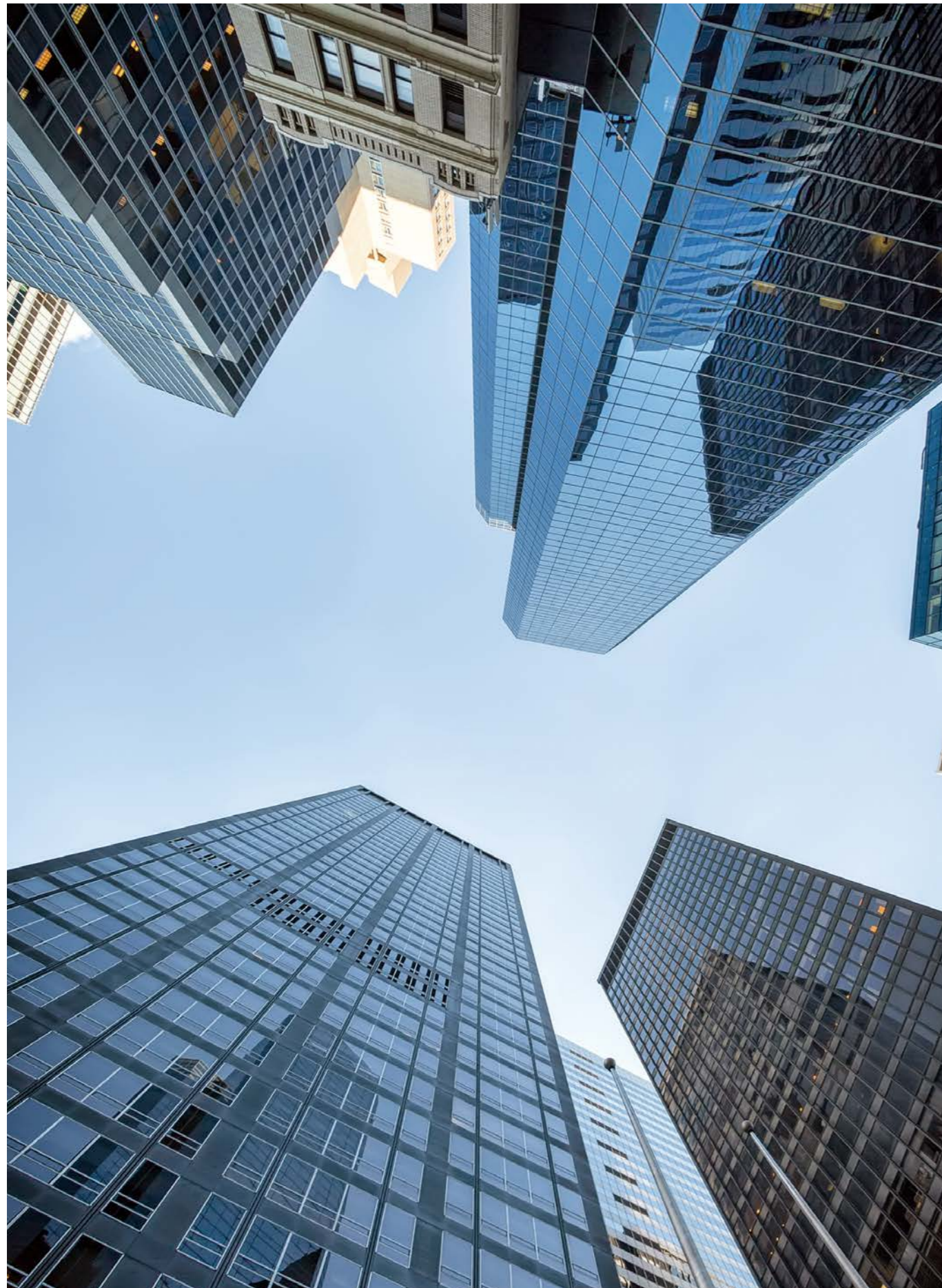

PDI (Power Distribution Indicator)

Features & Benefit

PDI shows distributed power consumption of up to 128 indoor units.



PQNUD1S40 (Premium, 8 port)
PPWRDB000 (Standard, 2 port)

Model Name	PQNUD1S40	PPWRDB000
Size (W x H x D, mm)	270 x 155 x 65	
Interfaceable Products	Air conditioner, ERV DX	
Maximum Number of Power Meters	EHP : 8 Watt meter / GHP : 4 Watt meter / 4 Gas meter	EHP : 2 Watt meter / GHP : 1 Watt meter / 1 Gas meter
Maximum Number of Indoor Units	MULTI V : 128	
Data Backup When Power Outage	○	
Power Input	PDI : AC 24V, Transformer : AC 220V	

※ ○ : Applied, - : Not Applied

- Total and indoor power consumption monitoring is possible.
- When connected to the LG central controller, it is possible to expand functions such as energy monitoring, energy saving operation and target usage setting.
- It is also possible to distribute gas consumption in addition to electricity.

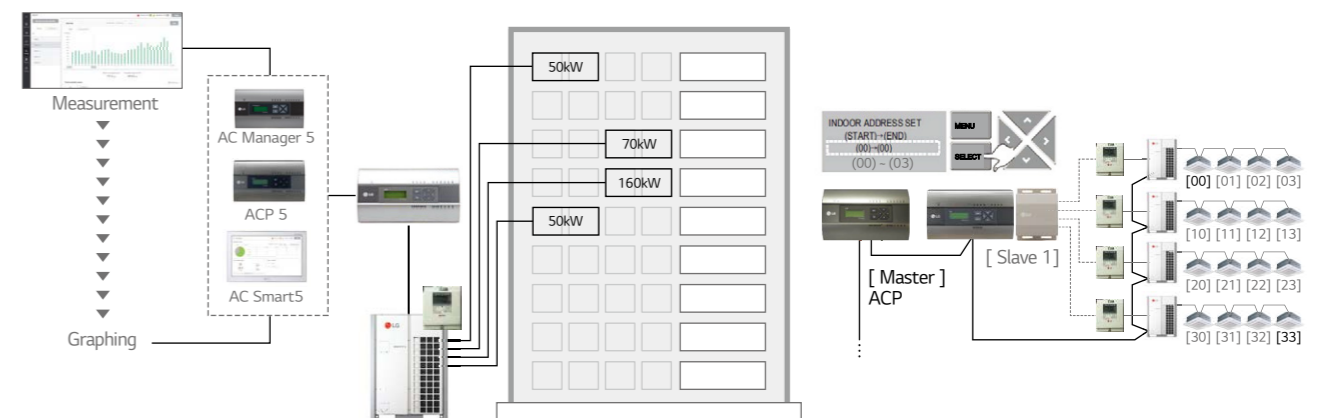
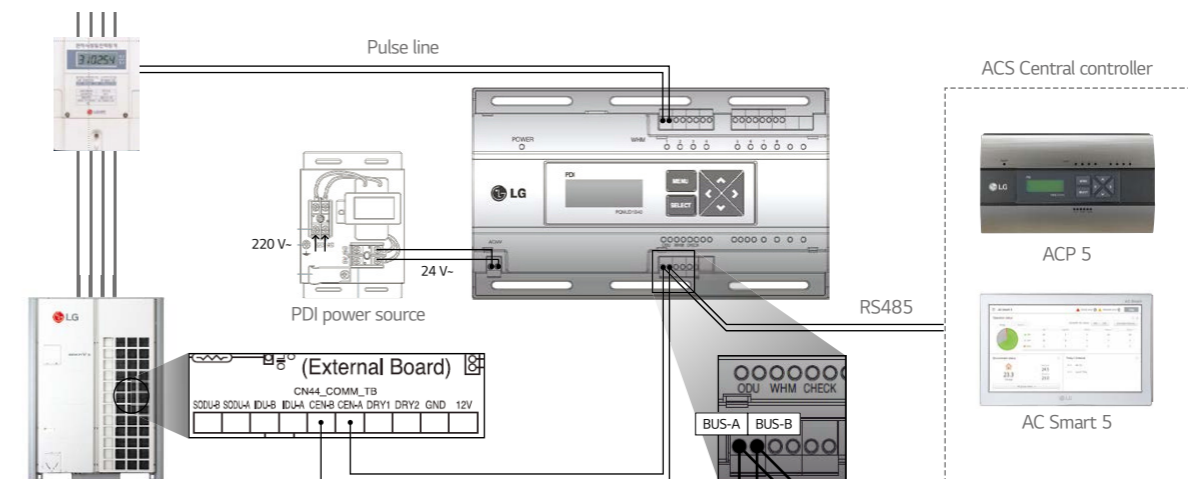

Note : 1. Power cable and type could be different from this scene depending on the Outdoor unit's specification.
2. Measured power consumption could be different between PDI and Watt meter.
3. Applicable Central Controller : ACP 5, ACP LonWorks, AC Smart 5, AC Ez Touch.
(Combination : we recommend to connect separated watt meter for Outdoor units to have correct power distribution value)

INTEGRATION DEVICE

ACS IO Module

Features & Benefit

This module can be connected with ACP 5 or AC Smart 5 controller if additional I/O points such as DI/DO and AI/AO for 3rd party devices control and monitoring are needed.



PEXPMB000

- Interlocking with 3rd party equipment LG Central controller can make operation scenario with 3rd party equipment by ACS IO Module.
- Control coverage is expanded.
(Air conditioner only → Sensors, Fans, Pumps, Switches...)

Model Name	PEXPMB000	
Linkable Products	PACS4B000 PACP4B000 PACS5A000 PACP5A000	
Communication	RS-485 1 ch.	
I/O	Digital Input	3 port
	Digital Output	3 port
	Universal Input ¹⁾	4 port
	Analog Output	4 port

Value Spec	Min.	Max.	
Analog Input	NTC 10k	0.68k Ω	177k Ω
	PT 1000	803 Ω	1,573 Ω
	Ni 1000	871.7 Ω	1,675.2 Ω
	DC (Voltage)	0V	10V
Analog Output	DC (Current)	0mA	20mA
	-	0V	10V
Digital Input	Binary Input (Non Voltage)	-	-
Digital Output	Normal open	-	30VAC / 30VDC, 2A

※ ○ : Applied, - : Not Applied
1) The type of UI (Universal Input) is selectable among Digital Input and Analog Input.

Key Application

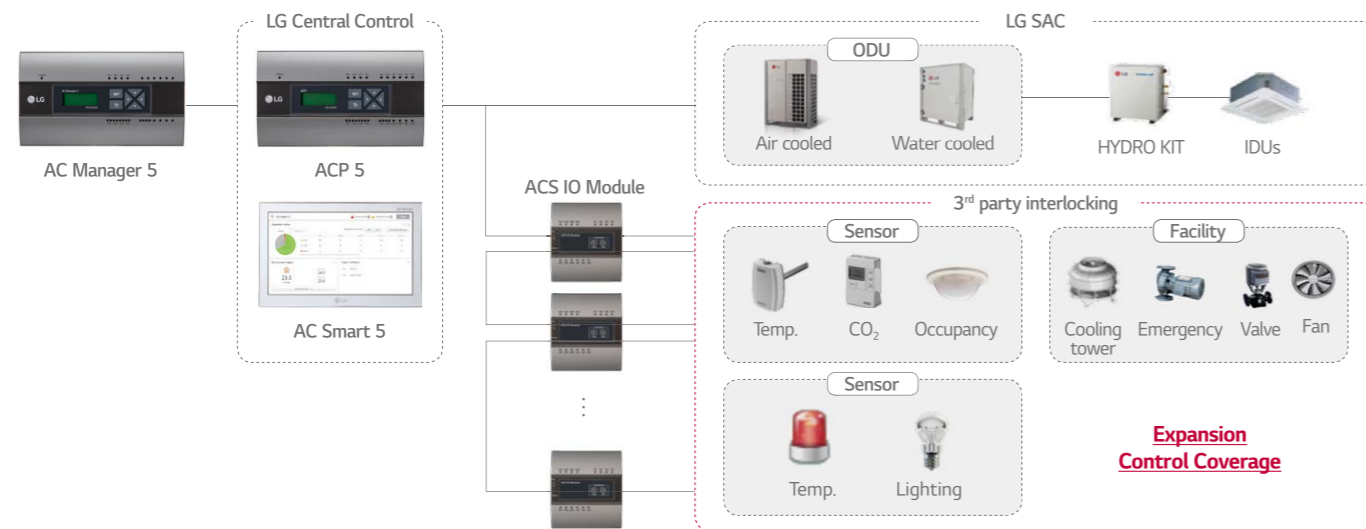

* DI : Digital Input, DO : Digital Output, UI : Universal Input, AO : Analog Output / Please contact our regional office to have connectable relay specification for analog output.

ACU IO Module

Features & Benefit

This module can be connected with ACP 5 or AC Smart 5 controller if additional I/O points such as UIO / UI / UO for 3rd party devices control and monitoring are needed.

ACU.UIO



PEXPMB300

ACU.UO



PEXPMB200

ACU.UI



PEXPMB100

- Interlocking with 3rd party equipment LG Central controller can make operation scenario with 3rd party equipment by ACU IO Module.
- Control coverage is expanded.
(Air conditioner only → Sensors, Fans, Pumps, Switches...)

Module Name	PEXPMB300	PEXPMB200	PEXPMB100
Linkable Products	PACS5A000, PACP5A000		
Communication RS-485	2 ch. ¹⁾	1 ch.	1 ch.
Digital Input	-	-	3port
Digital Output	2port	6port	-
Universal Input ²⁾	4port	-	6port
Analog Output	2port	4port	-

Value Spec		Min.	Max.
Analog Input	DC (Voltage)	0V	10V
Analog Output	DC (Voltage)	0V	10V
Digital Input	Binary Input (Non Voltage)	-	-
Digital Output	Normal Open	-	30VDC, 1A

※ ○ : Applied, - : Not Applied
1) 1ch. is reserved for internal communication.
2) The type of UI (Universal Input) is selectable among Digital Input and Analog Input.

Chiller Option kit

Features & Benefit

LG central controller 5 series with Chiller Option Kit can provide LG chiller remote control and cycle monitoring.



PCHLLN000

Model Name	PCHLLN000
Monitoring Points	Evaporator status / Compressor status (Scroll, Screw, Centrifugal chiller only) / Condenser status / Generator status (Abs. chiller only)
On / Off	○
Target Temp. setting	○
Mode Change	Scroll chiller only
Schedule	○
Interfaceable Products	Scroll, Screw, Centrifugal, Absorption (LG Only)

※ ○ : Applied, - : Not Applied

Cycle Display Example

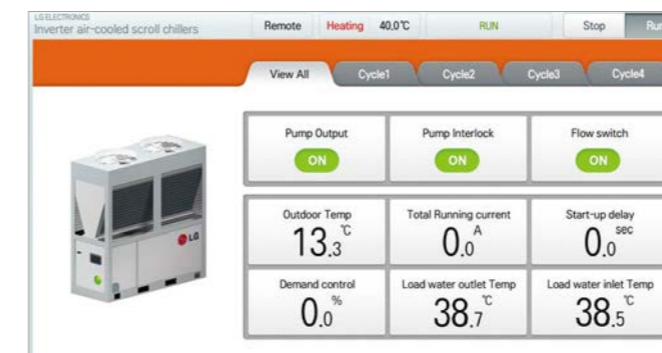

Installation Scene

- Chiller Option Kit installation of LG HVAC Solution product should be conducted by a specialized installation service engineer.
- Chiller Option Kit installation can be proceeded with a SD Card.
- The SD Card can install Chiller Option Kit in one LG HVAC Solution product.

Insert the SD Card in the LG HVAC Solution product. If a backup SD Card is inserted, replace it with a Chiller Option Kit SD Card.



INTEGRATION DEVICE

Dry Contact

Feature List

Connection between an indoor unit and external devices to control various functions.

Model Name	PDRYCB000	PDRYCB400	PDRYCB300	NEW PDRYCB320*	PDRYCB500
Case	○	○	○	○	○
Input Port	1	2	8	8	-
Universal Input port	-	-	-	1	-
Comm. Protocol	-	-	-	-	Modbus RTU
Power	AC 220V	Connect to Indoor unit PCB (CN_CC)			
Air conditioner	On / Off	○	○	○	○
	Oper Mode	-	○	○	○
	Set Temp.	-	(Select & Fix)	(Select & Fix)	(Select & Fix)
	Fan Speed	-	-	○	○
	Thermo-Off	-	(Select & Fix)	○	○
	Energy Saving	-	(Select & Fix)	-	-
	Lock/Unlock	-	(Select & Fix)	-	-
Control	On / Off	○	-	○	-
	DHW On / Off	-	-	○	-
	Thermo-Off	-	-	○	-
	Oper Mode	-	-	○	-
	Silent Mode	-	-	○	-
	Emergency Mode	-	-	○	-
	On / Off	○	-	-	-
Vent	Oper Mode	-	-	-	○
	Air conditioner Mode	-	-	-	○
	Additional Mode	-	-	-	○
Output	Operation Status	○	○	○	○
	Error	○	○	○	○
	Room Temp.	-	-	-	○

※ ○ : Applied, - : Not Applied

* Available from April 2020

Note : 1. Compatibility of PDRYCB300, PDRYCB320

- Can use with all types of air conditioner indoor units after 2010 (Cassette, Ducted, Convertible, Applied PAC, Wall mounted, Console)
- Can not use with single package models
- AWHP : 3 series split and monobloc models

2. Compatibility of PDRYCB400

- Can use with all types of air conditioner indoor units after 2010 (Cassette, Ducted, Convertible, Applied PAC, Wall mounted, Console)
- Can not use with single package models
- Can not use with AWHP, HYDRO KIT models

3. (Select & Fix) : This function is preset by rotary switch.

PDRYCB000

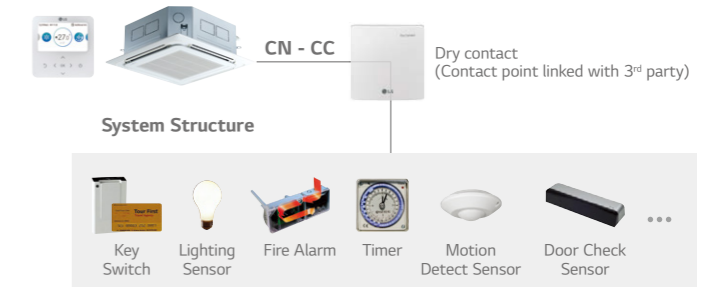

PDRYCB400



2 inputs interworking

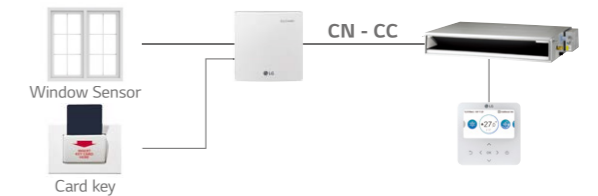

Refrigerant leakage detection alarm

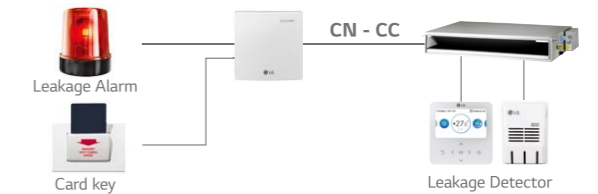

PDRYCB300 / PDRYCB320

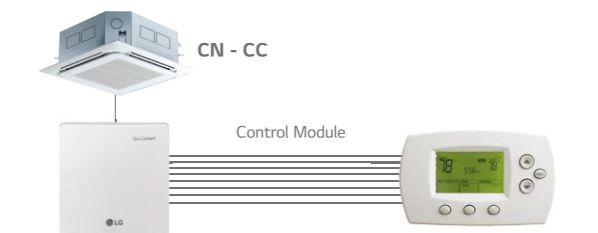
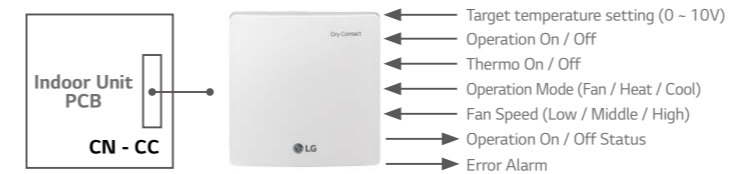

※ Can use a universal input port with PDRYCB320 model.

※ Please contact our regional office to have full compatible room controller list

PDRYCB500

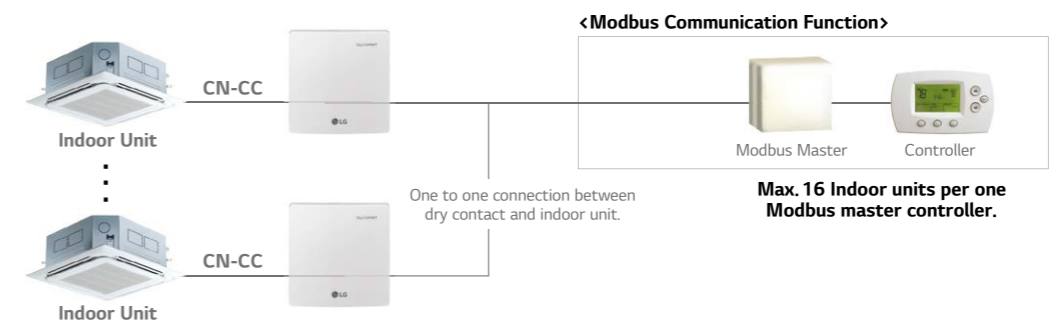

※ Please contact our regional office to check the compatibility with 3rd party room controller.

Max. 16 Indoor units per one Modbus master controller.

INTEGRATION DEVICE

Group Control Wire

Features & Benefit

Cables used to connect a wired remote controller up to 16 indoor units.



PZCWRCG3

Model Name	PZCWRCG3
Y-type Cable	0.25m Length
Long Cable	9.6m Length

Installation Scene

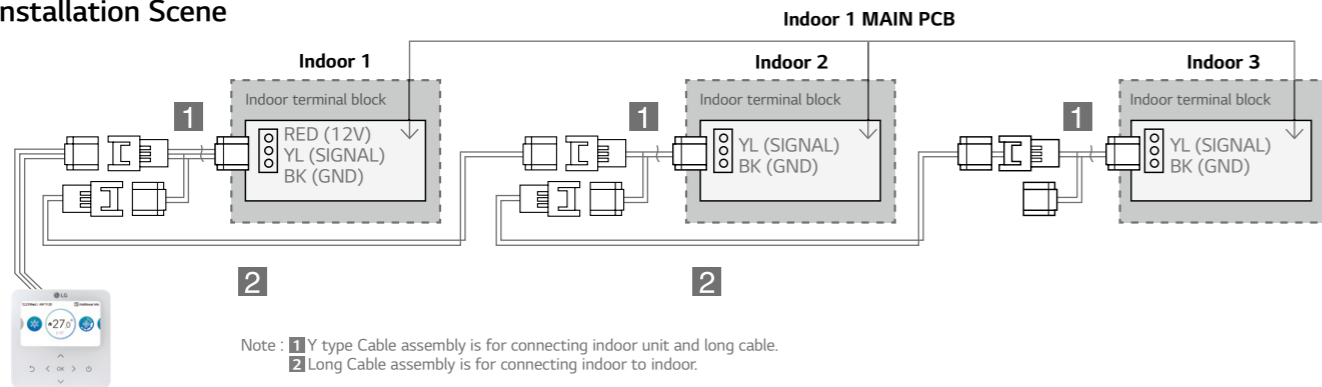

Remote Temperature Sensor

Features & Benefit

Sensor for detecting the room temperature.



PQRSTAO

- It detects the exact room temperature instead of indoor unit's air temperature sensor.
- Applied to Ceiling Mounted Cassette, Ceiling Concealed Duct, THERMA V and HYDRO KIT.
- Extension cable (15m) is included.

Installation Scene

1. Wire to the control box in the indoor unit by removing the existing thermistor and connect the extension cable its place.
2. Cut the extension cable to the appropriate length and connect the screw terminal of the remote sensor.

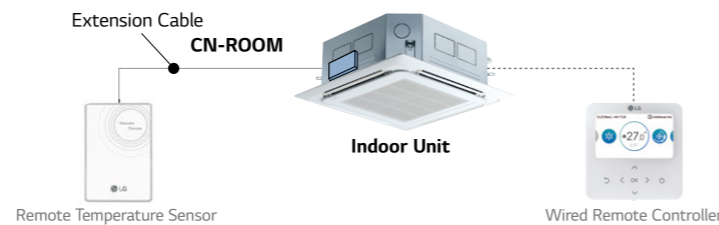

Low Profile Remote Temperature Button Sensor

Features & Benefit

This installs easily and discreetly into a wall and then connects to indoor unit.



ZRTBS01

Model Name	ZRTBS01	
Operation Range	-40°C to 85°C (0 to 100%RH, Non-condensing)	
Sensing Element	Thermistor	
Sensing Element Accuracy	0.2°C (0 to 70°C)	
Wire Leads	Material	Etched Teflon
	Length	15m
	Thickness	0.33mm ²
Mounting	10mm hole, push in plastic sheath with peel off tape strip	
Enclosure Material Ratings	Plastic, NEMA 1, UL94	

- Ideal for locations where aesthetics are as important as the temperature measurement.
- Inconspicuous wall sensor that mounts easily by pushing through a 10mm hole and secured with a peel off tape strip.
- Small flush sensor mounting.
- Accurate direct air measurement.
- Paintable with latex or oil base.

Key Application

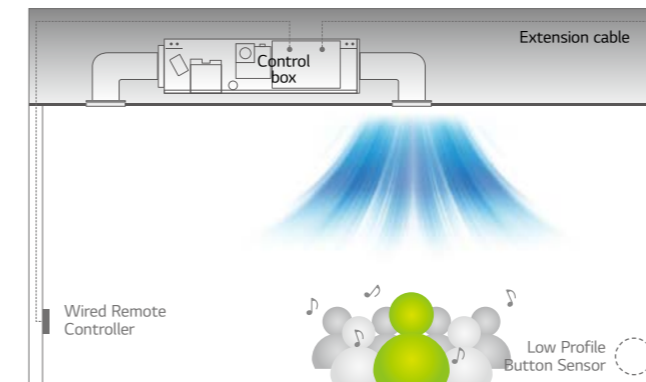

Models Applied

- LG indoor units excluding Wall-Mounted Type.

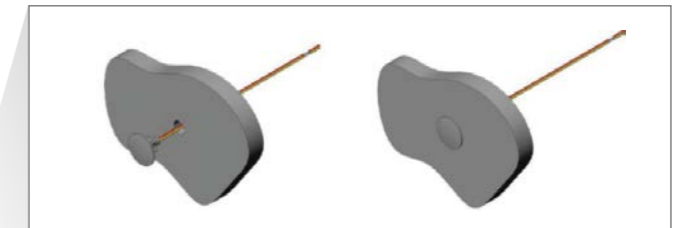

Installation Scene

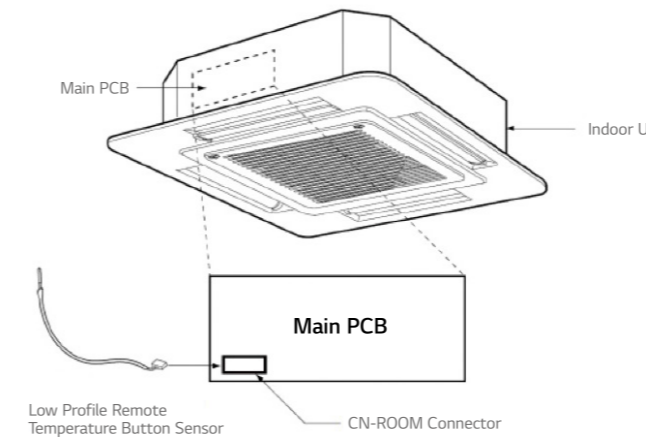

Drawing

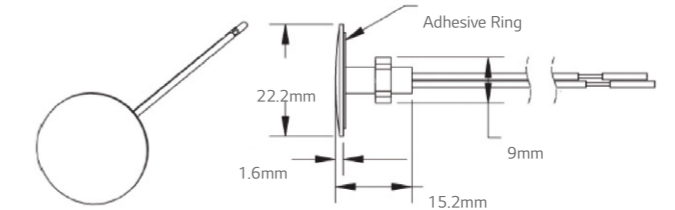

INTEGRATION DEVICE

Zone Controller

Features & Benefit

Controls air conditioning up to 4 zones by external thermostat.

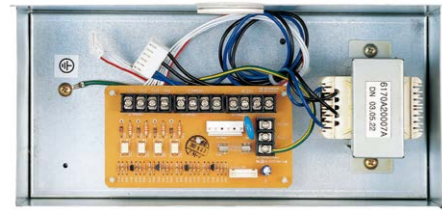

ABZCA

- Controls different zones (up to 4 zones) by external thermostat (AC 24V).
- Maintain proper air volume of each zone.
- Auto variation of dampers.
- Auto control of fan speed and On / Off operation.

Models Applied

- Ceiling Concealed Duct (refer to Product Data Book for applicable models).

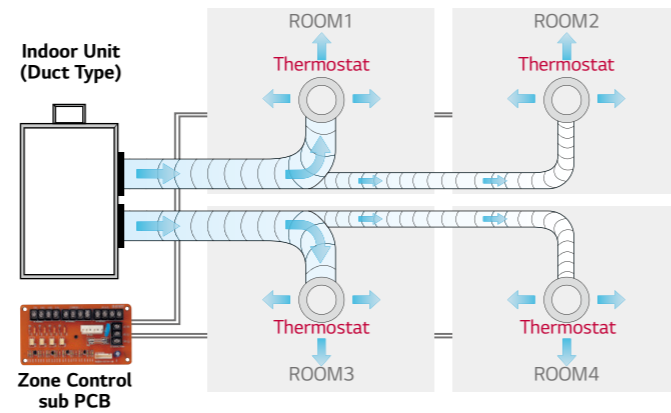

Wiring Diagram

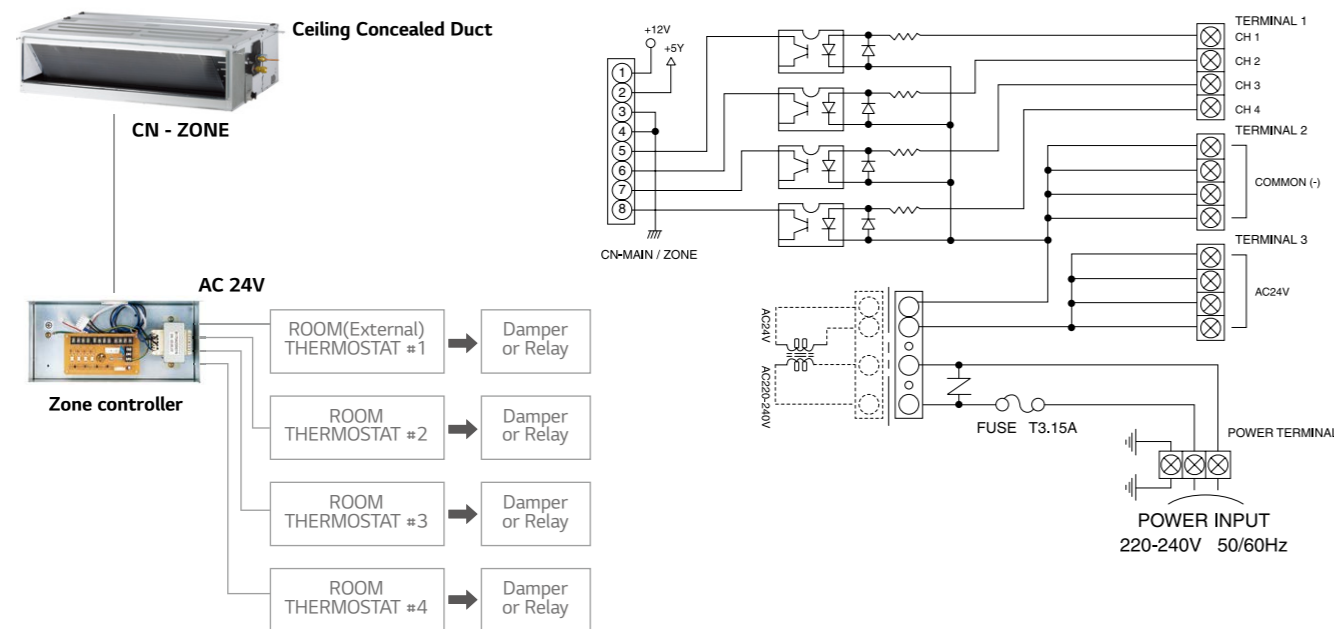

IO Module

Features & Benefit

Interface module between system air conditioner's outdoor unit and external device.



PVDSMN000

Function

- Demand control
- Low noise operation
- Output outdoor or indoor unit operation status
- Output error status

Description

• IO Module is communication interface module for connection between MULTI V 5 and external IO (Input / Output Module) devices.

Note : IO Module is not compatible for MULTI V III.

Models Applied

- MULTI V 5
- MULTI V S
- MULTI V WATER IV

Part Description

- 1) Digital Input Part (DI : Dry Contact Input)
 - Demand control by contact input (3 Step)
 - Low Noise Operation input
 - Priority Setting input : Setting the priority of demand control command (Capacity control for external signal from DDC vs Peak control by LG Central controller)
 - Open : External signal has priority to central controller (Default)
 - Close : Central controller has priority to external signal
- 2) Analog Input Part (AI : DC 0 ~ 10V)
 - Demand control by analog input (10 Step)
- 3) Digital Output Part (DO : AC 250V, Max. 1A)
 - Error status relay output
 - Operation status relay output
 - Valve control

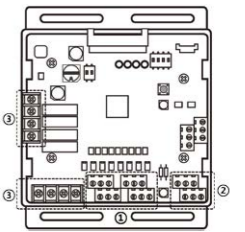

Key Application

Demand Control

Provides variable setting for demand control according to input method to reduce power consumption. This function supports 2 types of input signal : AI (0 ~ 10V, 10 Step) and contact signal (3 Step).

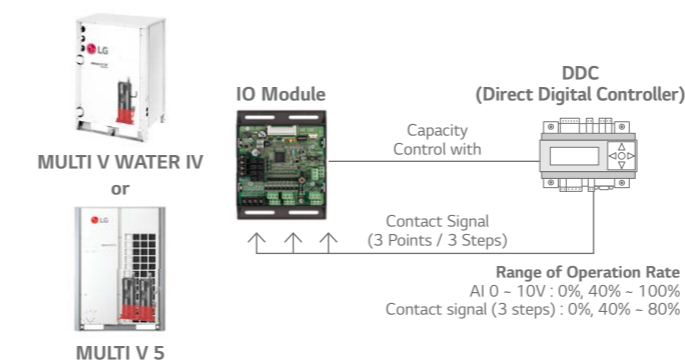

Low Noise Operation

To reduce noise level, control outdoor unit's fan speed by dry contact input.

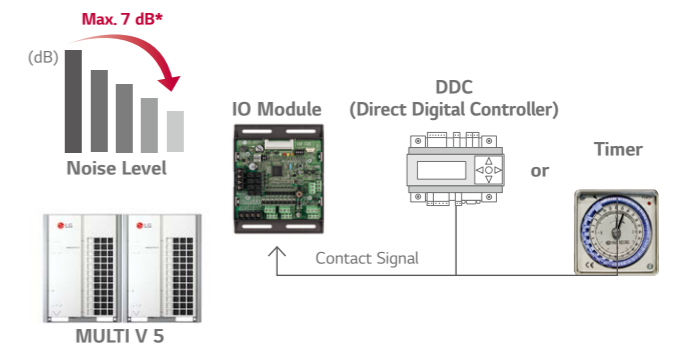

* 8 HP (22.4kW) model, Sound power level can be changed by outdoor unit operation status and low noise operation input signal.

Refrigerant Leakage detection with Pump-down

For safety, IO module close refrigerant valve when pump-down operation.

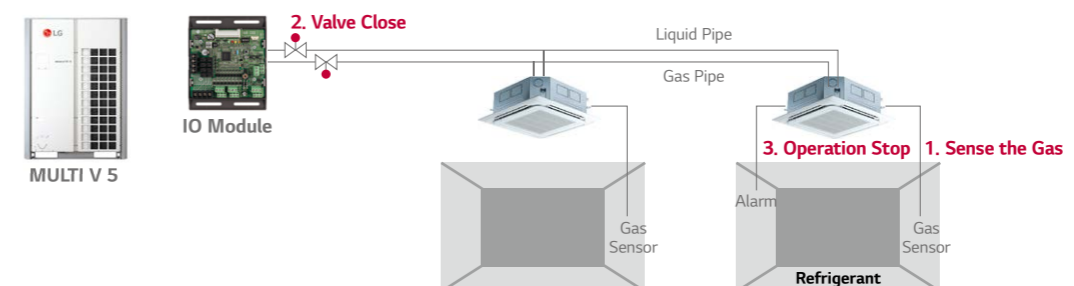

INTEGRATION DEVICE

Water Communication Module

Features & Benefit

This module is intended to connect 3rd party plate heat exchanger to LG outdoor unit with the ability to control water temperature from 3rd party DDC or LG remote controller.



NEW PAHCMW000

- Interlocking with 3rd parties can make various solution with LG MULTI V outdoor unit.

Contents	Connection Port	Function
RS485	CH1 (A+ / B-)	Module Comm. Port
	CH2 (A+ / B-)	IDU Comm. Port
Universal Input (Cooling / Heating Setting)	UI1	Flow Switch
	UI2	0 - 10V Set Temp
	UI3	Cooling Thermostat Signal
	UI4	Heating Thermostat Signal
Universal Input (DHW Only)	UI1	Flow Switch
	UI2	0-10V Set Temp
	UI3	DHW Temperature Transmitter 0 - 10V
	UI4	DHW Thermostat Signal
NTC	RI1	Water Inlet Sensor
	RI2	Water Outlet Sensor
REMO	+12V / SIG / GND	LG Remote Controller
Single	Reserved	-
Digital Output	DO1	Defrost / Mode
	DO2	Pump
	DO3	Bypass
NTC	RI3	Thermistor Pipe In
	RI4	Thermistor Pipe Out
EEV	+12V / 1 / 2 / 3 / 4	Expansion Valve

Compatibility & Accessory

EEV (LG MODEL)

Model	Capacity (kW)		PAHCMW000
	Min	Max	
PAEEVC000	3.6	28	HP/HR
PRLK048A0	3.6	28	HP/HR
PRLK096A0	28.1	56	HP

LG Controllers

Controller	Individual Controller	Centralized Controller		Dry Contact
	Standard III	AC EZ touch	AC smart 5	
	PREMTW101	PACEZA000	PAC55A000	PDRYCB000

LG Controllers

- The 3rd party can select the for best usable version.

Solenoid valve for Bypass

Capacity (kW)		EEV type	System	Kv Value of solenoid and Non-Return Valve	Pipe Size
Min.	Max.				
3.6	28	PAEEVC000	HP/HR	0.95	3/8" / 9.52mm
		PRLK048A0			
>28	56	PRLK096A0	HP	1.9	1/2" / 12.7mm

Flow switch

- The nominal flow and cut of flow can be calculated using the values below.

Controller	Nominal Flow	Flow switch Cut off
L/min*kW	3.29	1.23

* Example : ODU nominal Cooling Capacity 28 kW
 28 x 3.29 = 92.12 L/min nominal flow
 28 x 1.23 = 34.44 L/min flow switch cut off

Overview

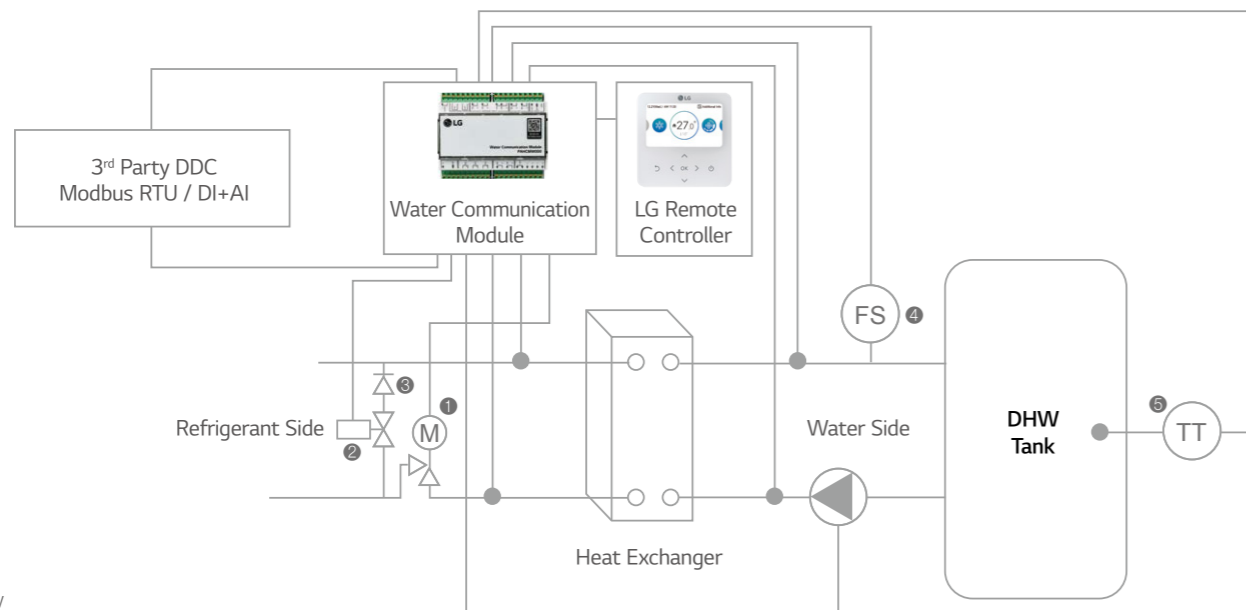

- ① EEV
- ② Solenoid Valve (NC)
- ③ Non-Return Valve
- ④ FS : Flow Switch
- ⑤ TT : DHW Temperature Transmitter

※ 3rd party solenoid, non-return valve, heat exchanger, flow switch and DHW temperature transmitter(optional) must be purchased separately (field supplied items)

INTEGRATION DEVICE

Water Communication Module Application

Installation scene with Contact connection

Contact signal + DHW Only Setting

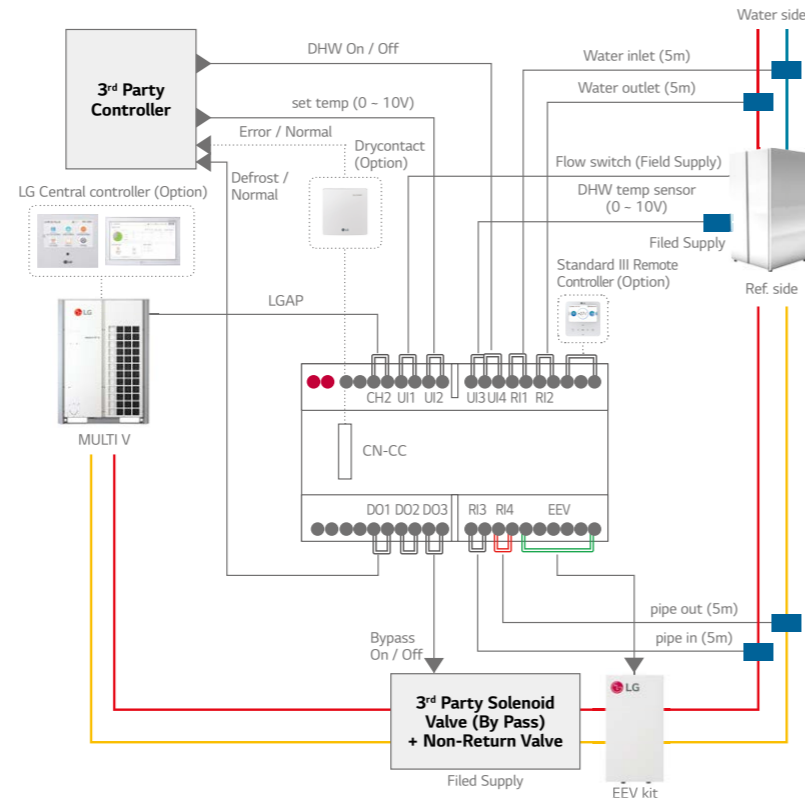

Installation scene with Modbus / LG Control (Optional) connection

Modbus + DHW Only Setting

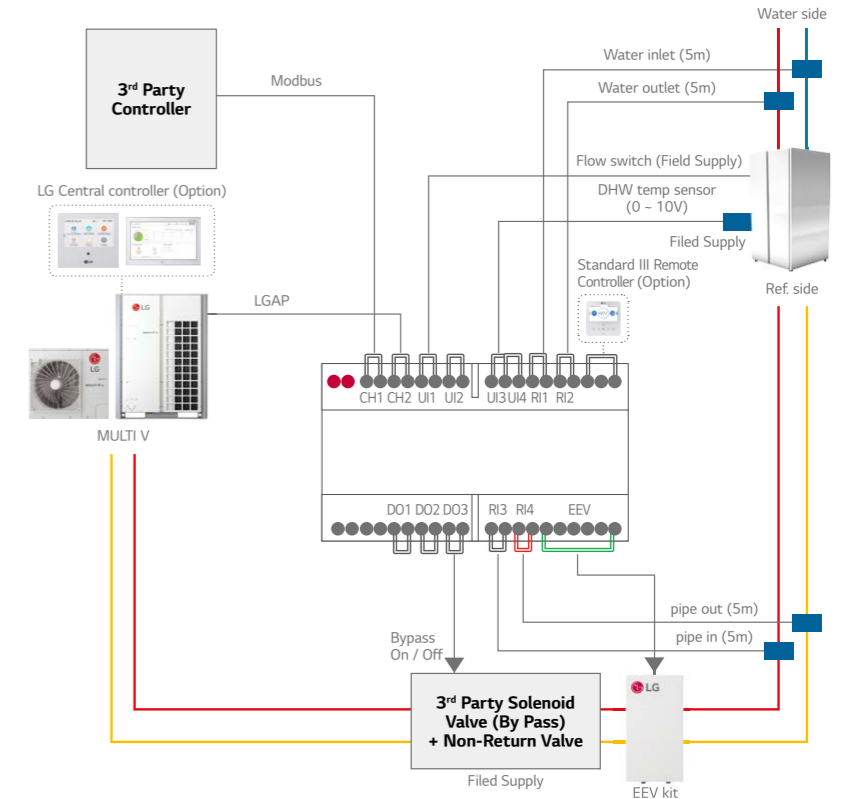

Contact signal + Heating / Cooling Setting

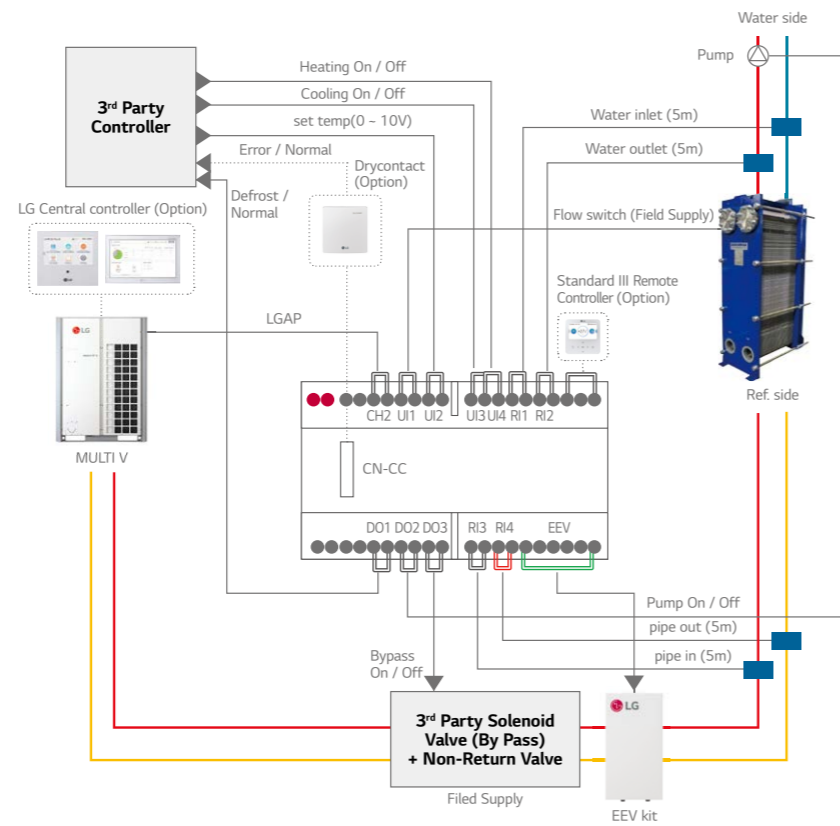

Modbus + Heating / Cooling Setting

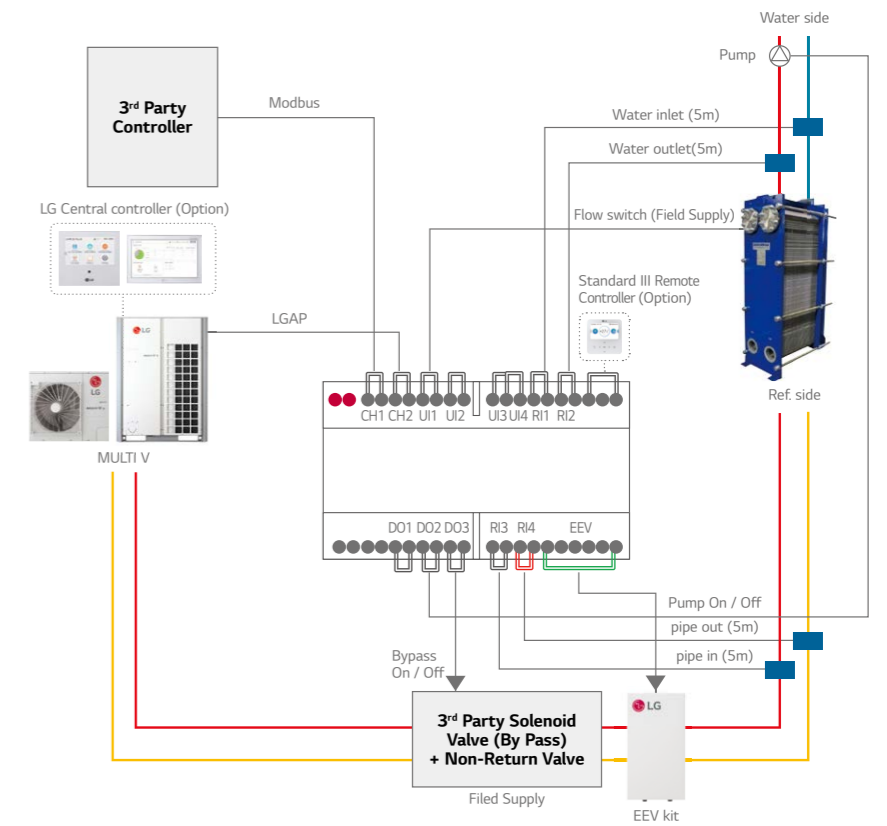

* In case of Contact control, LG controllers can only support monitoring functions

INTEGRATION DEVICE

Variable Water Flow Control Kit

Features & Benefit

Accessory developed for controlling the water flow.



PWFCKN000 (MULTI V WATER IV)

Function

- Water pump or valve control (0 ~ 10V)
- Minimum output voltage setting available
- Operation, error output (AC 250V, Max. 1A)
- Dry contact input and analog output for demand control
- Digital output for operation, error status (AC 250V, Max. 1A).

Advantage

- Water flow consumption reduction
- Pump electricity consumption reduction
- Including IO Module (Dry contact input, Analog input / output, Digital output)
- Using Dry contact and variable water flow control function simultaneously

Wiring Diagram

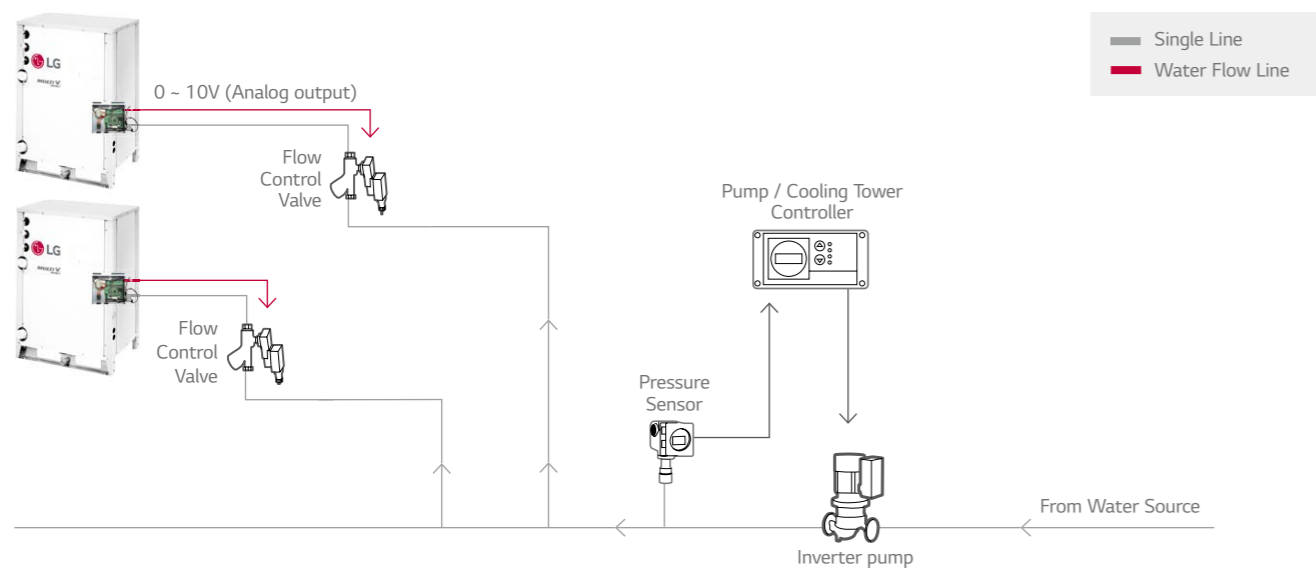

※ Flow control valve : Regulates the flow or pressure of a fluid, normally responding to signals generated by independent devices.
 ※ Flow Meter : Measures mass flow rate of a fluid traveling through a tube. (The mass flow rate is the mass of the fluid traveling past a fixed point per unit time.)
 ※ Pressure Sensor : Measures the pressure.

Low Ambient kit

Features & Benefit

External integration module for cooling operation with -25°C low ambient temperature.

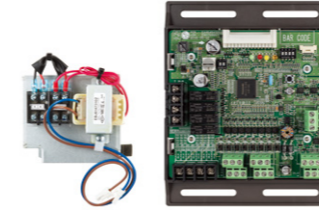

PRVC2

Function

- -25°C Low ambient cooling operation by Low ambient kit and hood with damper (Analog output 0 ~ 10V).
- Demand control
- Low noise operation
- Output outdoor or indoor unit operation status (AC 250V, Max. 1A)
- Output error status (AC 250V, Max. 1A)

Description

- Low ambient kit supports -25° C cooling operation by making stable condensing pressure with reducing air flow rate from hood and damper control given 0 ~ 10V proportional to condensing pressure.
- Low ambient kit provides IO Module function.
- External snow hood and air damper are required for this item.
- Transformer and terminal block are included.

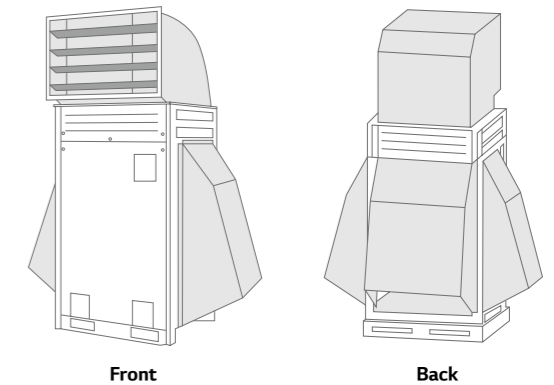

□ : Field Supply item

Models Applied

- MULTI V 5
- MULTI V IV

Installation Scene

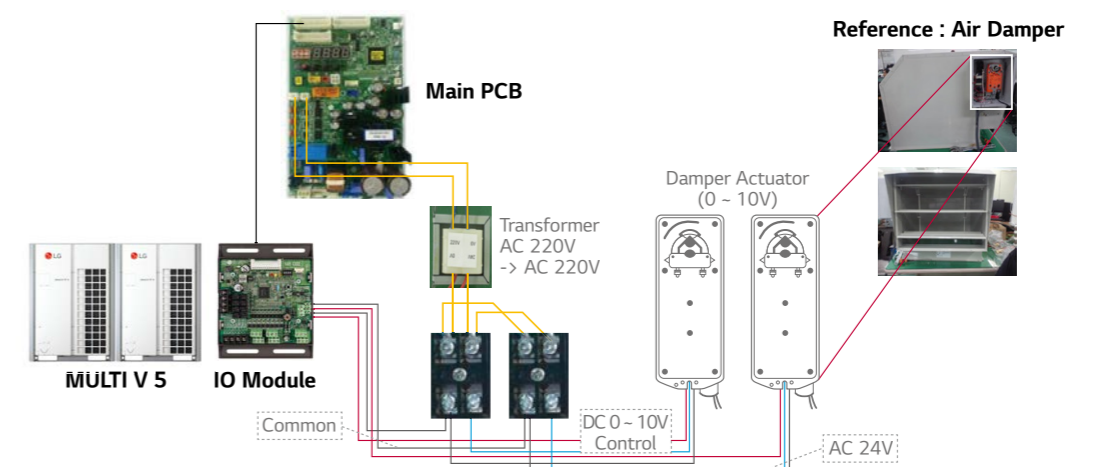

Note : The IO Module can control maximum three actuators. Please, review damper actuator's installation manual.

INTEGRATION DEVICE

Cool / Heat Selector

Features & Benefit

Cooling, heating, or fan mode can be selected to prevent cooling and heating mixing errors during seasonal changes.



PRDSBM

- Indoor unit mode control without central controller.
- Select operation mode : Cooling, Heating, Fan mode
- Mode lock for cooling & heating mixing error-proof during the change of season.

Models Applied

- MULTI V 5
- MULTI V IV
- MULTI V WATER II
- MULTI V S
- MULTI V PLUS II, MULTI V PLUS
- MULTI V WATER IV

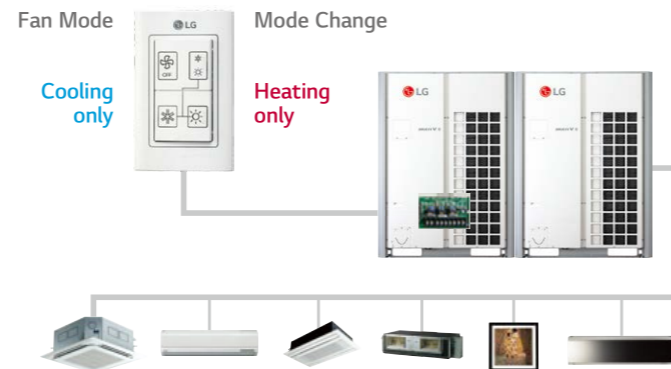

Wiring Diagram

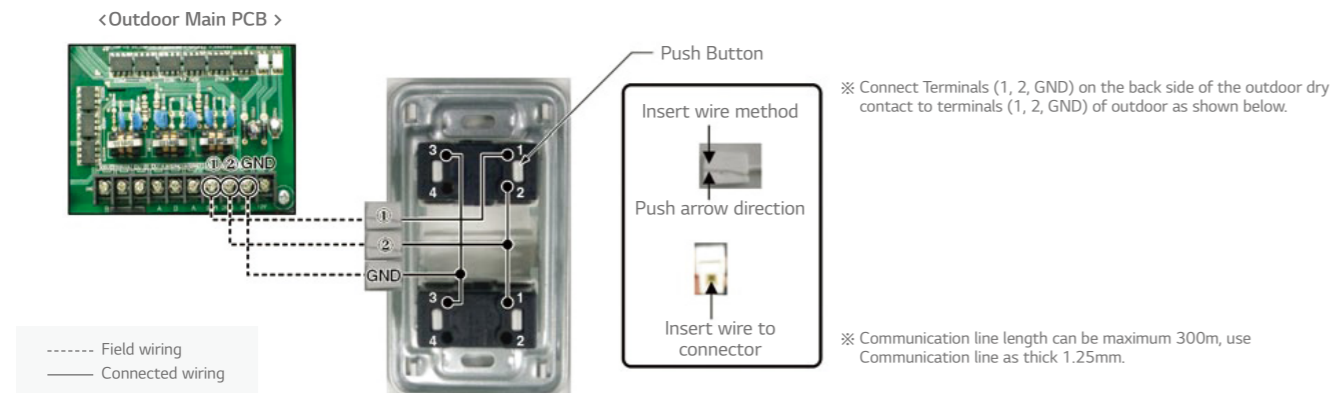

AHU Kits

Features & Benefit

A solution to connect LG's high efficiency system to the DX coil of an air handling unit for the maximum energy savings.



COMMUNICATION KIT

PAHCMR000

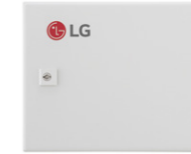

PAHCMS000

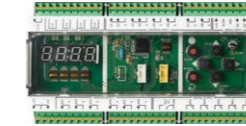

CONTROLLER MODULE

NEW PAHCMM000

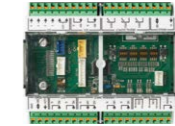

NEW PAHCMC000



CONTROL KIT

NEW PAHCNM000



EEV KIT

PRLK048A0
PRLK096A0



NEW PRLK396A0



NEW PRLK594A0

Specifications

Control Application Kit

Type	Model	Dimensions (mm)			Power Supply	IP Rating	Description
		W	H	D			
Communication Kit	PAHCMR000	300	300	155	1Ø, 220 ~ 240 V, 50/60 Hz	IP66	Return / Room air temperature control by DDC or LG individual / centralized controller
	PAHCMS000	380	300	155	1Ø, 220 ~ 240 V, 50/60 Hz	IP66	Discharge air / Supply air temperature control by DDC or LG individual / centralized controller
Controller Module	PAHCMM000	162	90	61	DC 12V	IP20	Main Controller module
	PAHCMC000	108	90	61	DC 12V	IP20	Communication Controller module
Control Kit	PAHCNM000	500	500	210	1Ø, 220 ~ 240 V, 50/60 Hz		Various AHU control functions with multiple DX coils (Maximum connectable ODU is 3 units)

※ O : Applied, - : Not Applied

Expansion Application Kit

Type	Model	Dimensions (mm)			Pipe Diameter (mm)	Capacity Index Range
		W	H	D		
EEV Kit	PRLK048A0	217	404	83	12.7	3.6 ~ 28 kW
	PRLK096A0	217	404	83	12.7	28.1 ~ 56 kW
	PRLK396A0	349.5	345.5	180	19.05	56.1 ~ 112 kW
	PRLK594A0	409.5	345.5	180	19.05	112.1 ~ 168 kW

※ O : Applied, - : Not Applied

INTEGRATION DEVICE

AHU Kits

Communication Kit

HIGH ENERGY EFFICIENCY

LG's DX AHU solutions are capable of performing all indoor air conditioning tasks with success under all operating conditions thanks to their superior performance with high efficiency heat source system.

Solution benefits offer the following advantages :

- High energy efficiency inverter system
- Large range of expansion application kit : Max. 168 kW EEV Kit ¹⁾
- Connected to various heat sources : MULTI V, MULTI V WATER, MULTI V S, SINGLE SPLIT

1) Maximum connectable EEV capacity for PAHCMR000, PAHCMC000 is 112 kW.

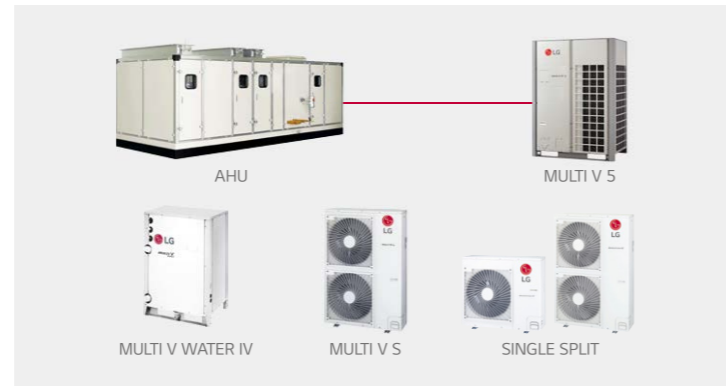

DIVERSE OPTIONS FOR CONTROL

AHU communication kit can be connected to various control system such as LG individual / central controller and DDC ¹⁾. It can be directly connected to DDC without separated controller, so DDC can receive product control and monitor information through contact signal or Modbus protocol.

- LG Individual / Central controller supported
- LG controller stand alone or combination with DDC
- Direct wiring between DDC and AHU communication kit
- Embedded Digital I/O and Analog Input
- Modbus RTU protocol supported

1) DDC : Direct Digital Controller

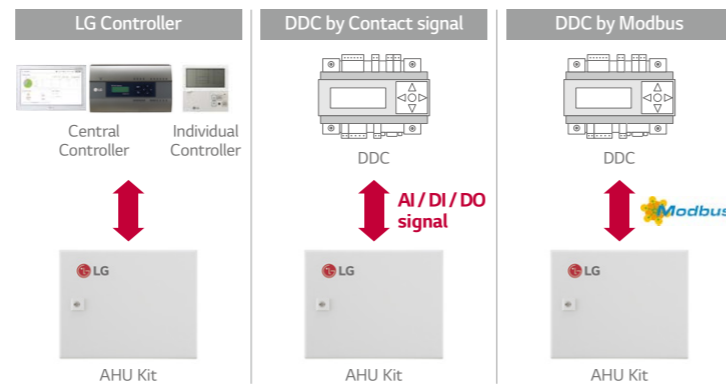

EXPANDABLE SYSTEM DESIGN

LG AHU system can be a suitable solution for various sites due to its application flexibility and wide range of line up with large capacity models. According to the required capacity, a single or multiple module combination is possible thanks to AHU communication kit's modular design.

- Multiple module combination for large capacity AHU.

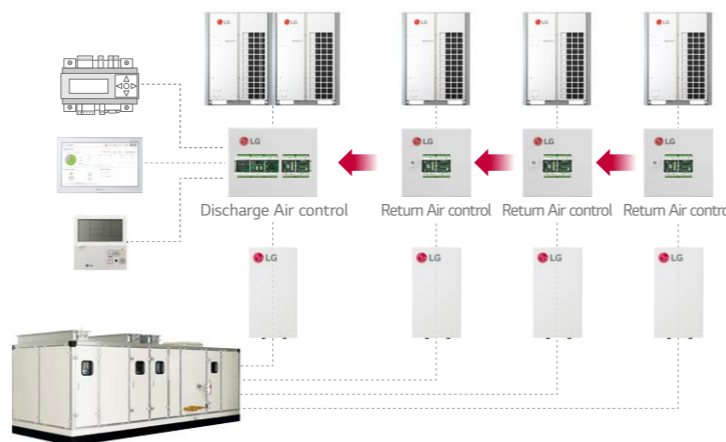

Single Split Application (Communication Kit & Controller Module)

Single Split + Return / Room Air Temperature Control

- Temp. Sensors
 - Comm. Line
 - Central Comm. Line to ODU
 - Ref. Pipe
- T_E = Evaporator Temperature (Liquid Pipe / Gas Pipe)
 T_R = Return Air Temperature
 T_{ROOM} = Room Air Temperature

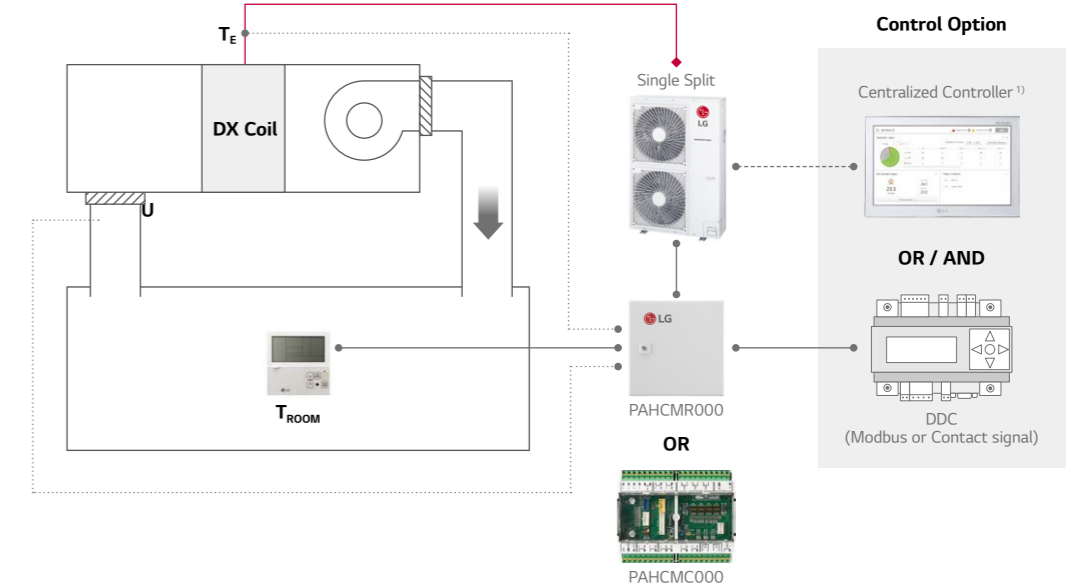

Single Split + Discharge Air Temperature Control

- Temp. Sensors
 - Comm. Line
 - Central Comm. Line to ODU
 - Ref. Pipe
- T_E = Evaporator Temperature (Liquid Pipe / Gas Pipe)
 T_D = Discharge Air Temperature
 T_{ROOM} = Room Air Temperature

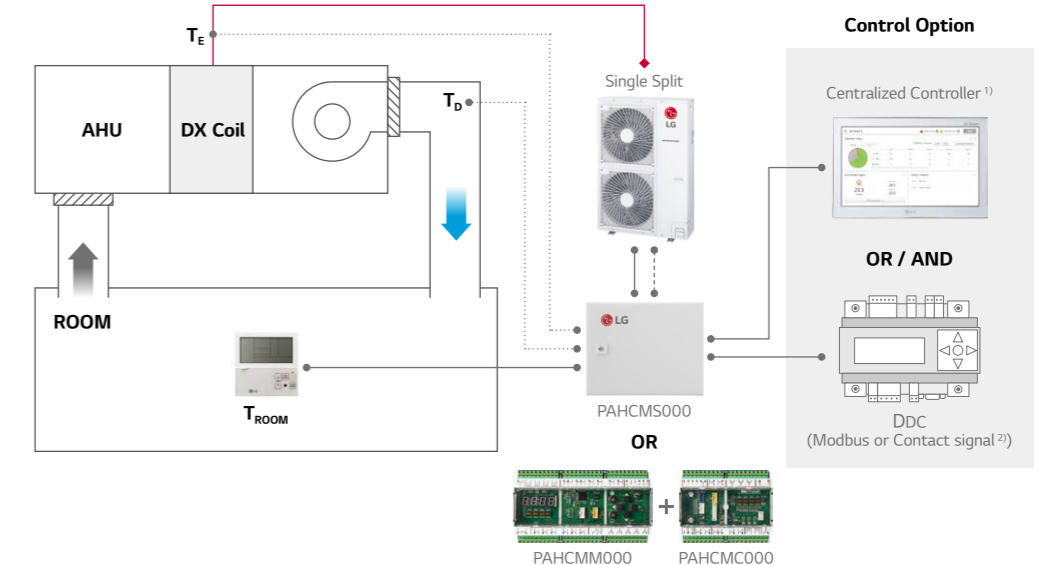

1) PI485 (PMNFP14A1) is required for centralized controller.

2) In case of applying DDC with contact signal, discharge air temperature should be measured and controlled by DDC.

Note : For more detail, please refer to the PDB.

INTEGRATION DEVICE

AHU Kits

MULTI V Application (Communication Kit & Controller Module)

MULTI V + EEV Kit + IDU + Return / Room Air Temperature Control

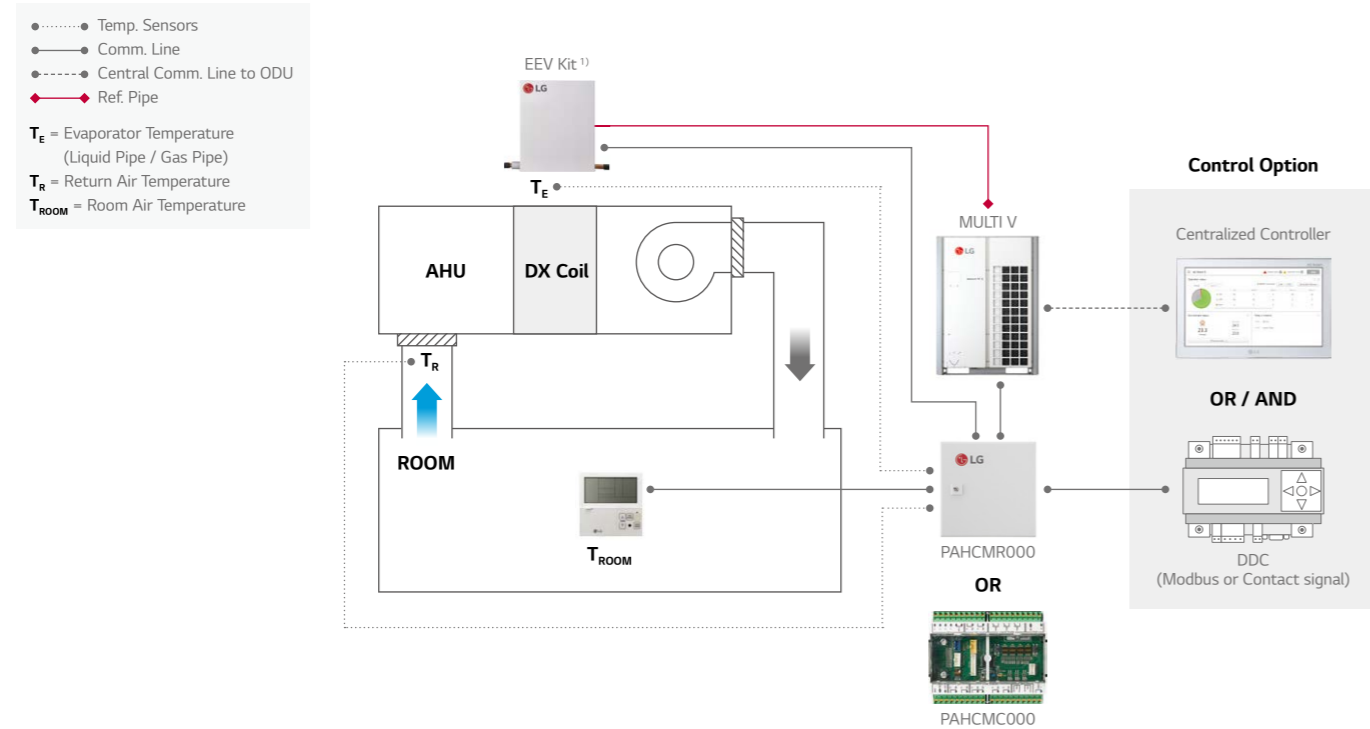

MULTI V + EEV Kit + Discharge Air Temperature Control

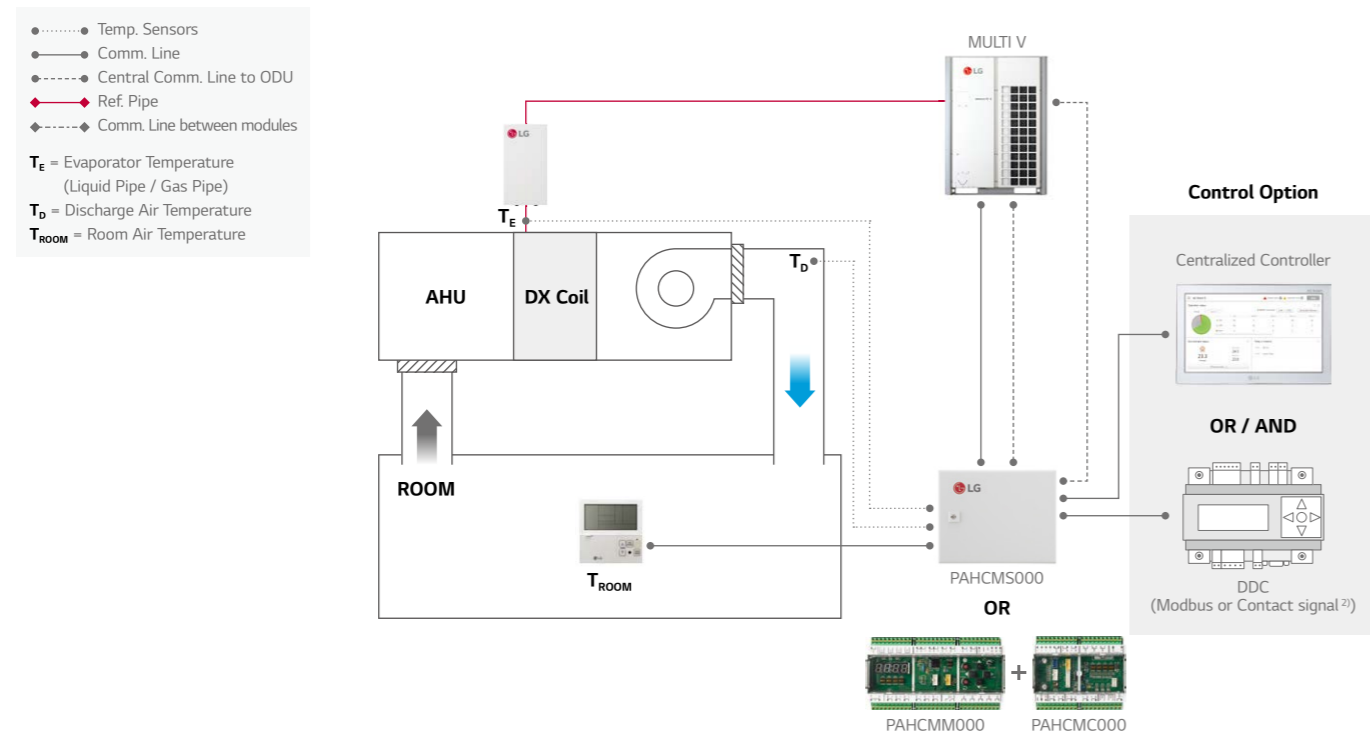

1) Multiple EEV kits can be applicable with multiple DX Coils and PAHCMR000s.
 2) In case of applying DDC with contact signal, discharge air temperature should be measured and controlled by DDC.
 Note : For more detail, please refer to the PDB.

AHU Kits

Communication Kit Function

Communication with DDC via Contact Signal

Function List	PAHCMR000 (PAHCMC000)	PAHCMS000 (PAHCMC000 + PAHCMC000)	Type	Note
Operation On / Off	On / Off	On / Off	Digital Input (Non Voltage)	-
Operation Mode	Cooling / Heating	Cooling / Heating	Digital Input (Non Voltage)	Available operation mode can vary depending on the settings of Communication Kit
Return(Room) Air Temperature ²⁾	16 - 30 °C	-	Analog Input (DC 0 - 10 V / 20mA)	-
Discharge Air Temperature ²⁾	-	-	-	Discharge air temperature should be controller directly by DDC using 'ODU Capacity Control'
Fan Speed ³⁾	-	High / Middle / Low	Digital Input (Non Voltage)	-
Forced Thermal On / Off	On / Off	-	Digital Input (Non Voltage)	-
ODU Capacity Control	-	40 ~ 100%	Analog Input (DC 0 - 10 V / 20mA)	-
Emergency Stop	-	Stop / Normal	Digital Input (Non Voltage)	-
Operation	On / Off	On / Off	Digital Output (Max : DC 30 V / 1 A, AC 250V / 1 A)	For PACHMR000, dip sw1-3 DO Type should be set 'Off' (Status), In this case, 'fan speed' cannot monitored by DO ports
Operation Mode	-	-	-	It needs to be checked through control signal
Fan Speed	High / Middle / Low	High/Middle/Low	Digital Output (Max : DC 30 V / 1 A, AC 250V / 1 A)	For PACHMR000, dip sw1-3 DO Type should be set 'On' (Fan Mode) In this case, 'On / Off, defrost, error Status' cannot monitored by DO ports
Defrost Operation	Defrost / Normal	Defrost / Normal	Digital Output (Max : DC 30 V / 1 A, AC 250V / 1 A)	For PACHMR000, dip sw1-3 DO Type should be set 'Off' (Status), In this case, 'fan speed' cannot monitored by DO ports
Error Alarm	Error / Normal	Error / Normal	Digital Output, Relay C contact (Max DC 30V / 1 A, AC 250V / 1 A)	For PACHMR000, dip sw1-3 DO Type should be set 'Off' (Status), In this case, 'fan speed' cannot monitored by DO ports
Compressor On / Off	-	On / Off	Digital Output (Max : DC 30 V / 1 A, AC 250V / 1 A)	-

1) Control functions for LG individual and central controller are not available in case of using together with DDC via contact signal.
 2) The range of temp. is differ depending on the type of the controller.
 3) To control fan speeds, DO port of the fan speed status should be connected to the fan control panel.
 Note : For more detail information, please refer to the product data book.

Communication with DDC via Modbus protocol

Function List	PAHCMR000 (PAHCMC000)	PAHCMS000 (PAHCMC000 + PAHCMC000)	Note
Operation On / Off	On / Off	On / Off	
Operation Mode	Cooling / Heating / Fan	Cooling / Heating / Fan	
Return (Room) Air Temperature	16 - 30 °C	-	
Discharge Air Temperature ¹⁾	-	12 - 50 °C	Dip SW1-2 Discharge Temp. Control Type should be set 'On'
Fan Speed ²⁾	High/Middle/Low	-	
Forced Thermal On / Off	-	-	
ODU Capacity Control ¹⁾	-	40 ~ 100%	Dip SW1-2 Discharge Temp. Control Type should be set 'Off'
Emergency Stop	-	-	
Operation	On / Off	On / Off	
Operation Mode	Cooling / Heating / Fan	Cooling / Heating / Fan	
Return (Room) Air Temperature	○	-	Corresponding air temperature sensor connected to AHU Comm. Kit is required
Discharge Air Temperature	-	○	
Fan Speed	High / Middle / Low	High / Middle / Low	
Defrost Operation	Defrost / Normal	Defrost / Normal	
Error Alarm	Error / Normal, Error code	Error / Normal, Error code	
Compressor On / Off	On / Off	On / Off	

※ ○ : Applied, - : Not Applied
 1) In case of PAHCMS000, control type between "Discharge Air Temperature" and "ODU Capacity Control" is selectable.
 2) To control fan speeds, DO port of the fan speed status should be connected to the fan control panel.
 Note : For the Modbus memory map and more detail information, please refer to the product data book.

INTEGRATION DEVICE

AHU Kits

Communication Kit Function

With LG Control system (Individual & Centralized Controller)

Function List	PAHCMR000 (PAHCMC000)	PAHCMS000 (PAHCMM000 + PAHCMC000)	Note
Control ¹⁾			
Operation On / Off	On / Off	On / Off	-
Operation Mode	Cooling / Heating / Fan	Cooling / Heating / Fan	Available operation mode can vary depending on the settings of Communication Kit
Return (Room) Air Temperature ²⁾	○	-	-
Discharge Air Temperature ²⁾	-	○	Standard II : 16 ~ 30 °C / Standard III : 12 ~ 50 °C (Available in April, 2020) / Central Controllers : 12~50°C
Fan Speed ³⁾	High / Middle / Low	High / Middle / Low	To control the AHU fan, dip switch 1-3 'DO type' should be set 'On(Fan Speed)' (PAHCMR000)
Monitor			
Operation	On / Off	On / Off	-
Operation Mode	Cooling / Heating/Fan	Cooling / Heating / Fan	-
Return(Room) Air Temperature	○	○	-
Discharge Air Temperature	-	○	-
Fan Speed	High / Middle / Low	High / Middle / Low	-
Defrost Operation	On / Off	On / Off	Only with Individual Controller
Error Alarm	Error Code	Error Code	Error code will be displayed on the screen
Compressor On / Off	On / Off	On / Off	Only with Individual Controller

※ ○ : Applied, - : Not Applied
 1) Control functions for LG individual and central controller are not available in case of using together with DDC via contact signal.
 2) The range of setting temperature is different depending on the type of the controllers. And operation may different from setting range.
 3) To control fan speeds, DO port of the fan speed status should be connected to the fan control panel.
 Note : For more detail information, please refer to the product data book.

Compatibility with LG HVAC Controllers

Controller	Individual Controller				Centralized Controller				BMS Gateway	PDI
	Premium	Standard III	Standard II	AC Ez	AC Ez Touch	AC Smart 5	ACP 5	AC Manager 5 ¹⁾	ACP LonWorks	Premium Standard
Model no.	PREMTA000 PREMTA000A PREMTA000B	PREMTB100 PREMTBB10	PREMTB001	PQCSZ250S0	PACEZA000	PACSSA000	PACP5A000	PACM5A000	PLNWKB000	PQNUD1S40 PPWRDB000
PAHCMR000	○	○	○	○	○	○	○	○	○	○
PAHCMS000	-	○ ²⁾	○	-	-	○	○	○	-	-

※ ○ : Applied, - : Not Applied
 1) AC Manager 5 is an integrator, so the installation with AC Smart 5 or ACP 5 is required. 2) Set temperature range of this model shall be extended April, 2020.
 Note : 1. Dry contact for indoor unit (PDRYCB000 / 400 / 300 / 500) is not applied. 2. For more details, please refer to the product data book.

Outdoor Unit Compatibility

For Small Size Application (~ 15 kW) - Single Split

Type	Model	UUA1 (2.5 ~ 5.0 kW) ¹⁾	UUB1 (5.0 ~ 8.0 kW) ¹⁾	UUC1 (7.1 ~ 10.0 kW) ¹⁾	UUD1 / UUD3 (10.0 ~ 15.0 kW) ¹⁾
Communication Kit (Controller Module)	PAHCMR000 (PAHCMC000) PAHCMS000 (PAHCMM000 + PAHCMC000)	-	○	○	○
Control Kit	PAHCNM000	-	-	-	-

For Medium-Large Size Application (~ 672 kW) - MULTI V

Type	Model	MULTI V				MULTI V WATER	
		5	IV	III	S	IV	II
Communication Kit (Controller Module)	PAHCMR000 (PAHCMC000) PAHCMS000 (PAHCMM000 + PAHCMC000)	○	○	○	○	○	○
Control Kit	PAHCNM000	○	○	○	○	○	○

Expansion Application Kit Compatibility

EEV Kit Model	Capacity index (kW)		Control Application Kit (Maximum connectable EEV Kits)			Connection by ODU system		
	Min.	Max.	PAHCMR000 (PAHCMC000)	PAHCMS000 (PAHCMM000 + PAHCMC000)	PAHCNM000	MULTI V		Single Split
						Heat Pump	Heat Recovery	
PRLK048A0	3.6	28	○ (1)	○ (1)	○ (6)	○	○	-
PRLK096A0	28.1	56	○ (1)	○ (1)	○ (6)	○	○ (Max. 33.7 kW)	-
PRLK396A0	56.1	112	○ (1)	○ (1)	○ (6)	○	-	-
PRLK594A0	112.1	168	-	○ (1)	○ (3)	○	-	-

※ ○ : Applied, - : Not Applied
 Note : 1. Table of the outdoor unit compatibility is based on European regional model. 2. When connecting outdoor units in other areas, please check whether they are compatible or not.
 3. Expansion application kit compatibility is based on capacity index of the system, it may be changed according to system design condition.

Control Kit

List	Required Item
Heating / Cooling	SA / RA temperature sensor (or SA / RA temperature & humidity sensor)
Automatic Ventilation	SA / RA temperature, CO ₂ sensor, Damper actuator (OA, EA, MA)
Energy Saving (Cooling Mode Only)	SA temperature, OA / RA temp&humidity sensor, Damper actuator (OA, EA, MA)
Humidification	SA temperature, RA temperature & humidity sensor, Humidifier
Inverter Fan Control	SA / RA temperature, Static pressure sensor, Inverter driver for fan control
Filter Alarm	Difference pressure sensor
Smoke Detecting	Smoke detection sensor

※ RA : Return Air, EA : Exhaust Air, OA : Outdoor Air, SA : Supply Air, MA : Mix air (RA + OA)

Field Supplied Item

List	Required Specification	Apply Location
Temperature Sensor	- Power : AC 24V, Output signal : DC 0 ~ 10V - Temperature boundary : -50 ~ 50°C	- Apply to MA, SA, RA
Temperature & Humidity Sensor	- Power : AC 24V, Output signal : DC 0 ~ 10V - Temperature boundary : -40 ~ 70°C - Humidity boundary : 0 ~ 95% RH	- Apply to SA, RA, OA - Can not be applied to MA
Damper Actuator	- Power : AC 24V, In/Output signal : DC 0 ~ 10V - Rotation angle : 90°	- Apply to OA, EA, MA damper
Difference Pressure Sensor (for Filter)	- Power : AC 24V, Output signal : DC 0 ~ 10V - Boundary : 0 ~ 1,000Pa - Switch type : Relay Open / Close	- Apply to filter
Static Pressure Sensor	- Power : AC 24V, Output signal : DC 0 ~ 10V - Boundary : 0 ~ 1,000pa	- Apply to SA (for inverter control)
CO ₂ Sensor	- Power : AC 24V, Output signal : DC 0 ~ 10V - Boundary : 0 ~ 2,000ppm	- Apply to RA duct
Smoke Detection Sensor	- Power : AC 24V, From : Contact point type	- Apply to RA duct

Various Control with Control kit – Multiple MULTI V + EEV Kits

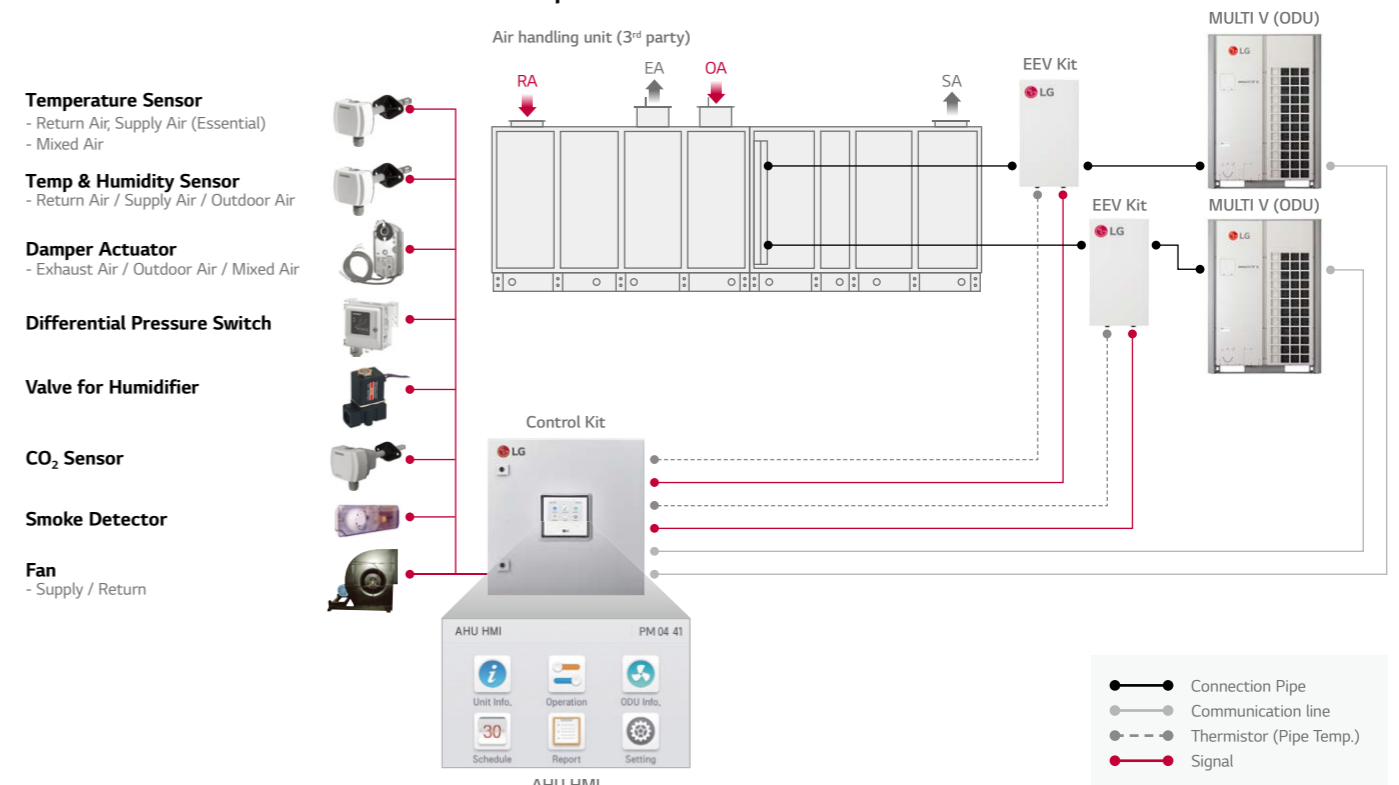

HOTEL APPLICATION

Hotel Control Solution



Guest Rooms

The air conditioner automatically turn off when guests leave.  Dry contact

Integrated control of air conditioner with the hotel room controller.  Dry contact

Control the air conditioner with an existing hotel thermostat.  Dry contact For thermostat

Guest safety is the first priority.  Refrigerant Leak detector















Reception

Air conditioner control in conjunction with check-in or check out.  AC Smart 5 (Schedule)

Public Areas

Centralized management of the public areas.  AC Smart 5 (Schedule)

Hotel Proposal / Design

Guest Room				Lobby	
<p>The air conditioner automatically turn off when guests leave</p> 	<p>Integrated control of air conditioner with the hotel room controller</p> 	<p>Control with existing hotel thermostat</p> 	<p>Guest safety is the first priority</p> 	<p>Air conditioner control in conjunction with check-in or check out</p> 	<p>Air conditioner control in conjunction with check-in or check out</p> 
 PDRYCB400 2 contact point	 PDRYCB500 Modbus RTU(9,600bps)	 PDRYCB300 / PDRYCB320* 8 contact point	 PRLDNVSO Refrigerant leakage detector • 6,000ppm	 PACSSA000 AC Smart 5 • BMS Integration (BACnet IP, Modbus TCP)	 PACSSA000 AC Smart 5 • BMS Integration (BACnet IP, Modbus TCP)
<p>Input</p> <ul style="list-style-type: none"> • Operation On / Off <p>Output</p> <ul style="list-style-type: none"> • Operation On / Off status • Error alarm 	<p>Function</p> <ul style="list-style-type: none"> • Operation • Indoor temperature • Error alarm • Set run mode • Set temperature • Set fan speed 	<p>Input</p> <ul style="list-style-type: none"> • Universal Input* • Operation On / Off • Thermo On / Off • Operation mode (Fan / Heat / Cool) • Fan speed (Low / Middle / High) <p>Output</p> <ul style="list-style-type: none"> • Operation On / Off status • Error alarm <p><small>* Available from April 2020</small></p>	 PREMTB100 Wired remote controller • 4.3 inch color LCD • Touch button	 PACP5A000 ACP 5 • BMS Integration (BACnet IP, Modbus TCP)	 PACP5A000 ACP 5 • BMS Integration (BACnet IP, Modbus TCP)

SHOPPING MALL APPLICATION

Shopping Mall Control Solution



Retail

Rationally distribute and manage the power consumption by tenants.  PDI

Fast problem detection and alarms.  Central controller (Operation trend)

Maintenance Office











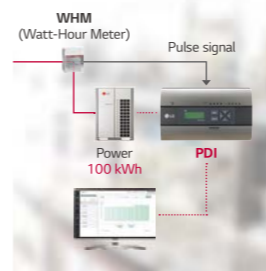

Reduces energy by checking operational trends.  Central controller (Operation trend)

Atrium

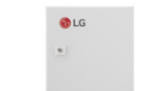
Integrated management of AHU applied to large spaces.  Comm. Kit

Chiller and VRF integrated control.  Central controller (Operation trend) +  Chiller option kit

Shopping Mall Reference

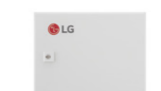
Retail	Maintenance Office	Atrium			
<p>Rationally distribute and manage power consumption by the tenant</p> 	<p>Fast problem detection and alarms</p> 	<p>Reduces energy by checking operational trends</p> 	<p>Integrated management of AHU applied to large spaces</p> 	<p>Chiller and VRF integrated control</p> 	
 PPWRDB000 PDI Standard (2 port) • Max. 128 IDU	 PACSSA000 AC Smart 5 • BMS Integration (BACnet IP, Modbus TCP)	 PAHCMR000 AHU Comm. Kit • Return air	 PCHLLN000 Chiller option kit +	 PACPSA000 ACP 5	 PACSSA000 AC Smart 5
 PQNUD1S40 PDI Premium (8 port) • Max. 128 IDU	 PACP5A000 ACP 5 • BMS Integration (BACnet IP, Modbus TCP)	 PAHMS000 AHU Comm. Kit • Discharge air			

HOSPITAL APPLICATION

Hospital Control Solution

Hospital Ward

- Proper airflow management for patients.
- Monitor the comfort level for each hospital ward.
- Control fan speed and air volume.

Service Zone

- Energy savings based on flexible scheduling.

Lobby

- Centralized management of AHU for large spaces.

- Wired remote controller
- Central controller (Comfort level)
- Dry contact
- Central controller (Schedule)
- Comm. Kit

Hospital Proposal / Design

Hospital Ward	Service Zone	Lobby
<p>Proper airflow management for patients</p> <p>PTVSMAO Human detection sensor</p> <p>PREMTB100 Wired remote controller</p> <ul style="list-style-type: none"> 4.3 inch color LCD Touch button 	<p>Monitor the comfort level for each hospital ward</p> <p>PACSSA000 AC Smart 5</p> <ul style="list-style-type: none"> BMS Integration (BACnet IP, Modbus TCP) <p>External device interlock control</p> <p>PDRYCB400 2 contact point</p> <p>Input</p> <ul style="list-style-type: none"> Operation On / Off <p>Output</p> <ul style="list-style-type: none"> Operation On / Off status Error alarm <p>PACPSA000 ACP 5</p> <ul style="list-style-type: none"> BMS Integration (BACnet IP, Modbus TCP) 	<p>Centralized management of AHU for large space</p> <p>PAHCMR000 AHU Comm. Kit</p> <ul style="list-style-type: none"> Return air <p>PAHCMS000 AHU Comm. Kit</p> <ul style="list-style-type: none"> Discharge air

EDUCATION APPLICATION

Education Control Solution

Class Room

- Automatically save energy in the absence of students.
- Central controls prevent students from arbitrary control.

Lecture Room

- Schedule management according to academic plan.

Maintenance Office

- Integrated management of distributed buildings.
- Centralized management with multiple interfaces.

- Wired remote controller
- Central controller (Lock)
- Central controller (Schedule)
- Central controller (Multiple management)
- Central controller (HTML5)

Education Proposal / Design

Class Room	Lecture Room	Maintenance Office
<p>Automatically save energy in the absence of students</p> <p>PTVSMAO Human detection sensor</p> <p>PREMTB100 Wired remote controller</p> <ul style="list-style-type: none"> 4.3 inch color LCD Touch button 	<p>Central controls prevent students from arbitrary control</p> <p>PACSSA000 AC Smart 5</p> <ul style="list-style-type: none"> BMS Integration (BACnet IP, Modbus TCP) <p>Schedule management according to academic plan</p> <p>PACPSA000 ACP 5</p> <ul style="list-style-type: none"> BMS Integration (BACnet IP, Modbus TCP) 	<p>Integrated management of distributed buildings</p> <p>PACMSA000 AC Manager 5</p> <p>Centralized management with multiple interfaces</p>

OFFICE APPLICATION

Office Control Solution

Maintenance Office

Energy savings and management throughout the building.

Integrated management of HVAC with BMS system.

Reduce costs by replacing BMS.

Office Room

Reasonable power distribution to tenants.

Server Room

Main equipment 24 hours back up management.

Meeting Room

Energy savings based on occupancy detection.

Office Proposal / Design

Maintenance Office	Office Room	Server Room	Meeting Room
<p>Energy savings and management throughout the building</p> <p>Integrated management of HVAC with BMS system</p> <p>Reduce costs by replacing BMS</p> <p>Target Forecasting</p> <p>BMS Protocol BACnet, Modbus</p> <p>BMS System SIEMENS, Honeywell, Johnson Controls</p> <p>Pump, Lighting, Fan, Sensor</p>	<p>Reasonable power distribution to tenants</p> <p>WHM (Watt-Hour Meter) Pulse signal</p> <p>Power 100 kWh</p> <p>PDI</p>	<p>Main equipment 24 hours back up management</p> <p>Error</p> <p>A B</p> <p>24 HOURS</p>	<p>Energy savings based on occupancy detection</p> <p>Human detection sensor</p>
 PACS5A000 AC Smart 5 • BMS Integration (BACnet IP, Modbus TCP)	 PLNWKB000 LonWorks gateway	 PACPSA000 AC Smart 5 • BMS Integration (BACnet IP, Modbus TCP)	 PTVMA00 Human detection sensor
 PACP5A000 ACP 5 • BMS Integration (BACnet IP, Modbus TCP)	 PMBUSB00A Modbus RTU gateway	 PQN1S40 PDI Premium (8 port) • Max. 128 IDU	 PREMTB100 Wired remote controller • 4.3 inch color LCD • Touch button
 PEXPMB000 ACS IO Module	 PEXP300 PEXPM200 PEXPM100 ACU IO Module	 PPWRDB000 PDI Standard (2 port) • Max. 128 IDU	 PREMTB100 Wired remote controller • 4.3 inch color LCD • Touch button

RESIDENTIAL APPLICATION

Residential Control Solution

Home

Control your home air conditioner anytime, anywhere.

Living Room

Build a smart house.

Bed Room

Use a familiar residential thermostat.

Apartment / Residence

Stable system operation.

Residential Proposal / Design

Home	Living Room	Bed Room	Apartment
<p>Control your home air conditioner anytime, anywhere</p>	<p>Build a smart house</p>	<p>Use a familiar residential thermostat</p> <p>Simple interlocking control by remote control</p>	<p>Stable system operation when indoor unit power is lost</p>
 PWFMDD200 LG Wi-Fi modem	 PDRYCB500 Modbus RTU (9,600bps)	 PDRYCB300 / PDRYCB320* 8 contact point	 PRIPO Independent power module • EEV full close function
<p>Function</p> <ul style="list-style-type: none"> • On / Off • Fan speed • Operation mode • Vane control • Reservation (Sleep, Weekly On / Off) • Error check 	<p>Function</p> <ul style="list-style-type: none"> • Operation • Indoor temperature • Error alarm • Set operation mode • Set temperature • Set fan speed 	<p>Input</p> <ul style="list-style-type: none"> • Universal Input* • Operation On / Off • Thermo On / Off • Operation mode (Fan / Heat / Cool) • Fan speed (Low / Middle / High) <p>Output</p> <ul style="list-style-type: none"> • Operation On / Off status • Error alarm <p>* Available from April 2020</p>	<p>PREMTB100 Wired remote controller • 4.3 inch color LCD • Touch button</p>

ACCESSORIES

• MECHANICAL ACCESSORIES

• PIPING ACCESSORIES



MECHANICAL ACCESSORIES

Cassette Panel

Key Features

Stylish designed panels make more unique space by various applications.

Dual Vain Panel



PT-AAGW0,
PT-AFGW0 (Air Purify)

4 Way Cassette Panel



PT-QCHW0, PT-MCHW0

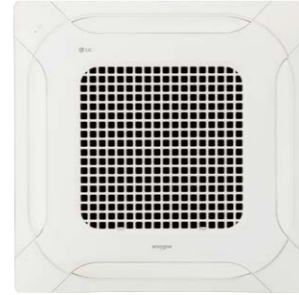

PT-MCGW0,
PT-MPGW0 (Air Purify)

2 Way Cassette Panel



PT-USC

1 Way Cassette Panel



PT-TAHW0 / PT-UAHW0



PT-TPHG0 / PT-UPHG0
(Air Purify)



PT-UTC / PT-UUC / PT-UUC1



PT-UTD / PT-UUD

- Independent vane operation uses separate motors, making it Possible to control all 4 vanes independently.
- The detachable corner design makes it easy to adjust the hanger during installation and to check for leakages in the drain pipe and refrigerant pipes.

Specification

Model	Suction Type	Color (RAL)	Gloss	Weight (kg)	Dimension (mm)			Applied model capacity (kW)*					
					W	H	D	MULTI V		Single Split		Multi Split	
								R410A	R32	R410A	R32	R410A	
Dual Vain	PT-AAGW0	Grill	Noble White (RAL 9003)	-	7.1	950	35	950	1.6 - 14.5	-	-	-	-
	PT-AFGW0 (Air Purify)	Grill	Noble White (RAL 9003)	-	7.5	950	35	950	1.6 - 14.5	-	-	-	-
4 Way	PT-QCHW0	Grill	Morning Fog (RAL 9001)	-	3.0	620	35	620	1.6 - 6.2	2.5 - 5.0	2.5 - 5.0	1.5 - 5.3	1.5 - 5.3
	PT-MCHW0	Grill	Morning Fog (RAL 9001)	-	6.3	950	35	950	7.1 - 15.8	6.8 - 14.6	6.8 - 14.6	6.7	-
	PT-MCGW0	Grill	Morning Fog (RAL 9001)	-	5.0	950	35	950	7.1 - 15.8	6.8 - 14.6	6.8 - 14.6	6.7	6.7
	PT-MPGW0 (Air Purify)	Grill	Morning Fog (RAL 9001)	-	5.0	950	35	950	7.1 - 15.8	6.8 - 14.6	6.8 - 14.6	6.7	6.7
2 Way	PT-USC	Grill	Morning Fog (RAL 9001)	-	4.7	1,100	28	690	2.8 - 7.1	-	-	-	-
1 Way	PT-TAHW0	Grill	Ivory White	-	3.3	1,100	34	500	1.2 - 4.0	-	-	2.3 - 4.0	2.3 - 4.0
	PT-UAHW0	Grill	Ivory White	-	3.3	1,100	34	500	1.2 - 4.0	-	-	2.3 - 4.0	2.3 - 4.0
	PT-TPHG0	Grill	White	○	3.9	1,160	34	500	1.2 - 4.0	-	-	2.3 - 4.0	2.3 - 4.0
	PT-UPHG0	Grill	White	○	3.9	1,160	34	500	1.2 - 4.0	-	-	2.3 - 4.0	2.3 - 4.0
	PT-UTC	Grill	Noble White (RAL 9003)	○	5.5	1,420	34	500	5.6 - 7.1	-	-	-	-
	PT-UUC	Grill	Noble White (RAL 9003)	○	4.6	1,100	34	500	2.2 - 3.6	-	-	-	-
	PT-UUC1	Grill	Noble White (RAL 9003)	-	4.4	1,100	34	500	-	-	-	2.6 - 3.5	2.6 - 3.5
	PT-UTD	Panel	Noble White (RAL 9003)	○	5.5	1,420	34	500	5.6 - 7.1	-	-	-	-
	PT-UUD	Panel	Noble White (RAL 9003)	○	4.6	1,100	34	500	2.2 - 3.6	-	-	-	-

* Based on cooling capacity.
※ ○ : Applied, - : Not applied

Cassette Cover

Key Features

Cover in case of exposed cassette installation.

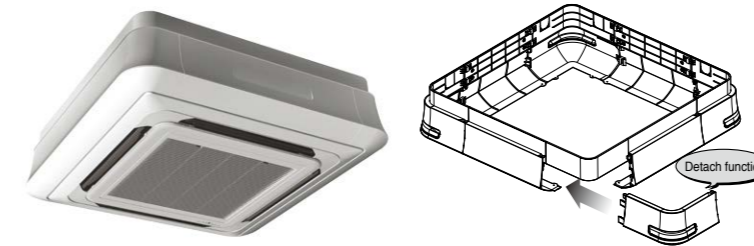

- Specially designed for indoor unit
- Covers the side area of cassette
- Gives elegant looks
- Light weight

Model Name

PTDCM / PTDCQ

Applied Products

4 Way Cassette (for chassis TP, TN, TM, TQ, TR)

Included Parts

- Cover A, Cover B
- Cover C, Cover D
- Screws
- Installation Manual

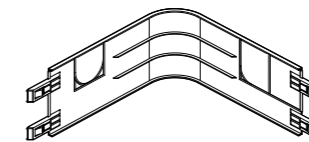

Cover A (4 units)

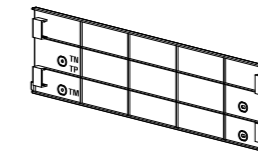

Cover B (4 units)



Screw (32 units)

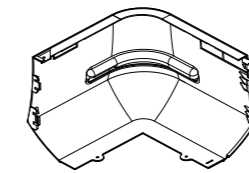

Cover C (4 units)

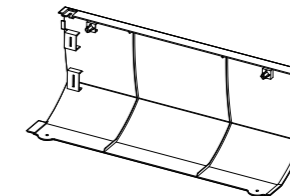

Cover D (4 units)

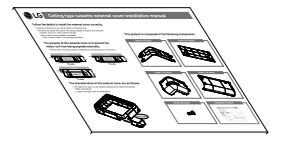

Installation Manual

Specification

Model	Front Panel		Weight (kg)		Dimensions (mm)		
			NET	Gross	W	H	D
PTDCM	PT-UMC / PT-UMC1	TP / TN	5.9	8.8	1,157	1,157	268
		TM	5.9	8.8	1,157	1,157	310
PTDCQ	PT-UQC	TR	5.0	7.2	907	907	268
		TQ	5.0	7.2	907	907	310

MECHANICAL ACCESSORIES

CO₂ Sensor

Key Features

CO₂ sensor in ventilation system.

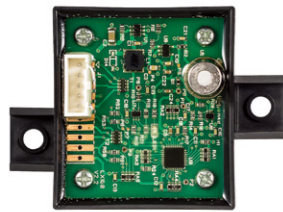

Specification

- Applied Model : ERV (Embedded), ERV DX (Option)
- Supply voltage : DV12V ± 5%
- Output : 0.6 ~ 4.4V (Linear output, 240 ~ 1,760 ppm CO₂)
- Accuracy : ± 10% (2 days after installation)

Description

- The product is especially designed to detect CO.
- This model requires Standard III Wired Remote Controller for display.

Model Name

AHCS100H0

Applied products

LZ-H025GBA4
LZ-H035GBA5 / LZ-H050GBA5 / LZ-H080GBA5
LZ-H100GBA5 / LZ-H150GBA5 / LZ-H200GBA5

Applicable products

LZ-H050GXN0 / LZ-H080GXN0 / LZ-H100GXN0
LZ-H050GXH0 / LZ-H080GXH0 / LZ-H100GXH0

Dimensions

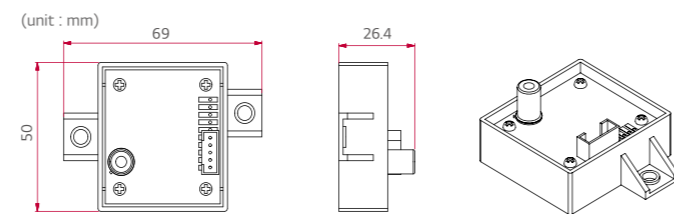

Key Application

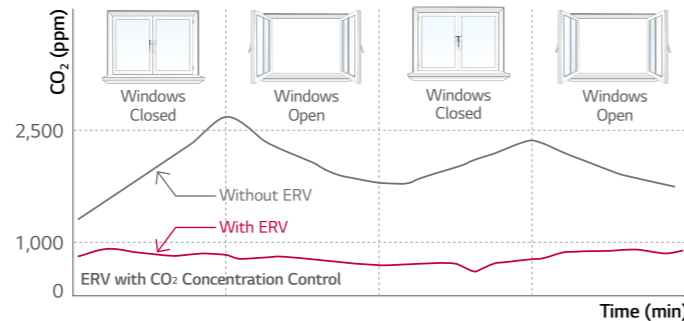
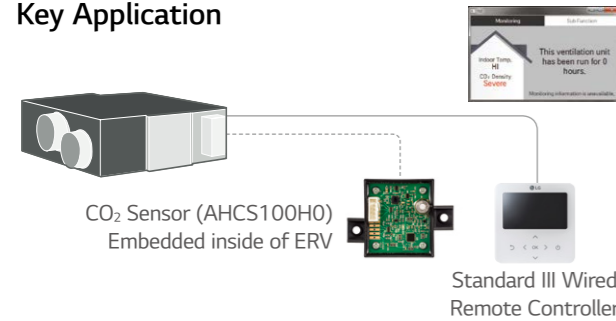

How to Install

1. Remove a screw on the service cover. Pull the service cover fixing bracket (①), then remove the service cover (②). Remove two elements (③) and two air filters (④).
2. Install the sensor with two screws.
3. Remove a screw, then remove the right side of element rail (⑤).
4. Press the holder (⑥) into the hole to fix the CO₂ sensor cable (⑦).
5. Connect the wire terminal to the CN-CO₂ port of PCB.

※ Airflow can be controlled by concentration of CO₂, after setting automatic operation mode at remote controller.
※ Use the screwdriver whose total length is less than 250mm.

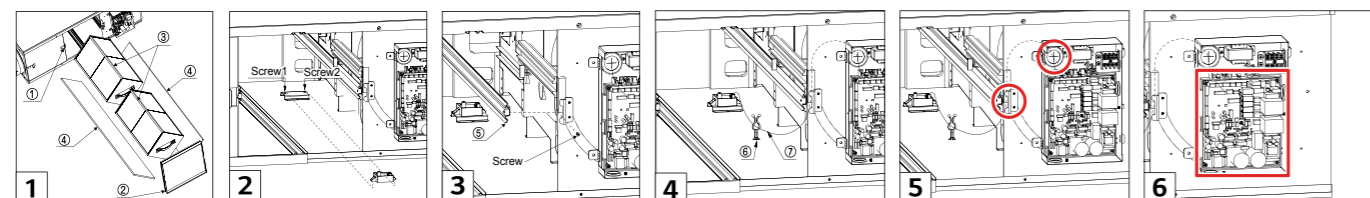

Refrigerant Leakage Detector

Key Features

R410A refrigerant leakage detector makes our space safer.



- This detector senses refrigerant leakage when the refrigerant concentration exceeds 6,000ppm. (The green and red LED lights blink simultaneously)
- Alarm is "ON" over 6,000ppm has been maintained 5 seconds, and Alarm is "OFF" under 6,000ppm has been maintained 5 seconds.
- When the alarm of the refrigerant leak detector is switched on the user must ventilate the room until the alarm is disabled.
- The detector has to be installed inside the room and it should be installed 300 ~ 500mm above the floor.

Model Name

PRLDNVSO

Applied Products

MULTI V 5
MULTI V IV Heat Pump & Heat Recovery
MULTI V Water IV

Specification

Parts	Specifications	
Sensor	Rated voltage (V)	DC 5.0 ±5%
	Dimensions (W x H x D, mm)	31 x 44 x 20
	Weight (g)	22
	Detectable refrigerant	R410A
	Detected concentration (ppm)	0 / 6,000 Alarm Off / On
	Operating temperature range (°C)	-10 ~ 50
	Preserved temperature range (°C)	-40 ~ 60
Connecting Cable	Average power consumption (mA)	35
	Cable length (m)	10
Sensor Protective Cover	Dimensions of front Plate (W x H x D, mm)	80 x 110 x 44.6
	Dimension of backplate (W x H x D, mm)	80 x 110 x 6.5

※ This function available for ARU***L**5 and 4 (MULTI V 5, MULTI V IV H/P, H/R model)

Included Parts

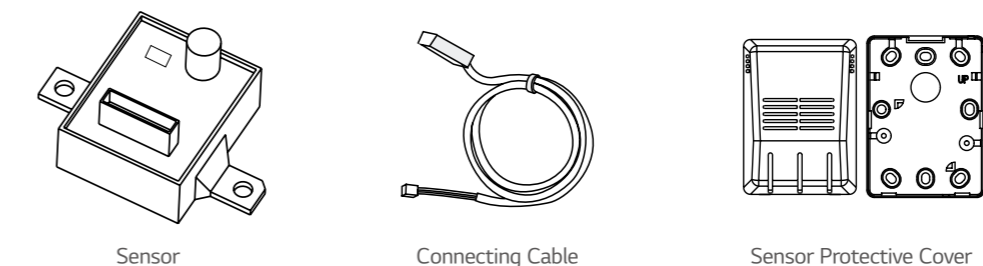

Key Application

Refrigerant Leakage Detector has three application methods.

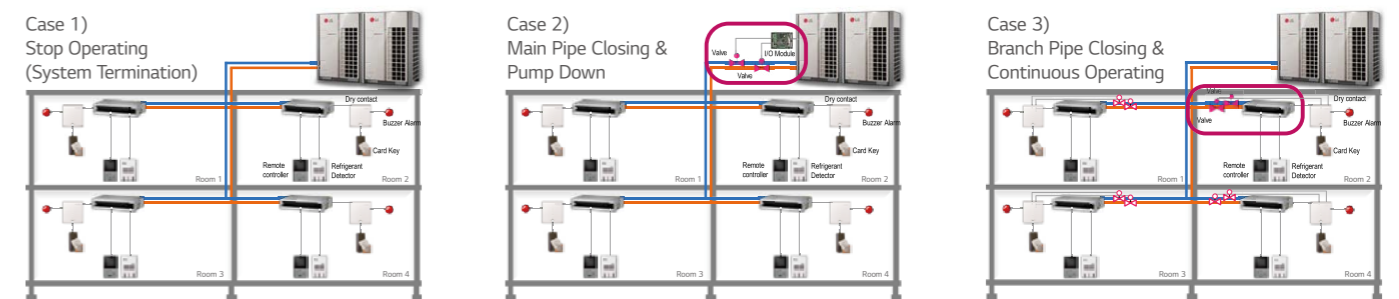

Accessory Specification (To realize the case 2 application)



MECHANICAL ACCESSORIES

EEV Kit

Key Features

MULTI V EEV KIT is specially designed to reduce noise and make comfort environment.



- Decreasing noise level of MULTI V Indoor units and easy installation.

Model Name

PRGK024A0

Applied Products

Indoor Unt	Model	Chassis	Applicable	Indoor Unt	Model	Chassis	Applicable
Cassette	1 Way Cassette	TU	○	Etc	Floor Standing	CE	○
	2 Way Cassette	TT	N/A		CF	-	
		TS	○(-5.6kW)		VE	○	
	4 Way Cassette	TR	○		Ceiling Suspended	V1	-
		TQ	○(-4.5kW)		V2	-	
		TP	N/A		Wall Mounted	SJ	○
		TN	N/A		SK	○	
TM		-	SV		-		
Duct	High Sensible	BG	-		Art Cool	SF	○
		BR	-		Console	QA	○
		BB	-		HYDRO KIT	K2	-
	High Static	B8	-		K3	-	
		M1	○(-5.6kW)		※ ○: Applied, -: Not applied, N/A : Not Applicable		
	Middle Static	M2	-				
		M3	-				
		L1	○				
	Low Static	L2	-				
		L3	-				

Key Application

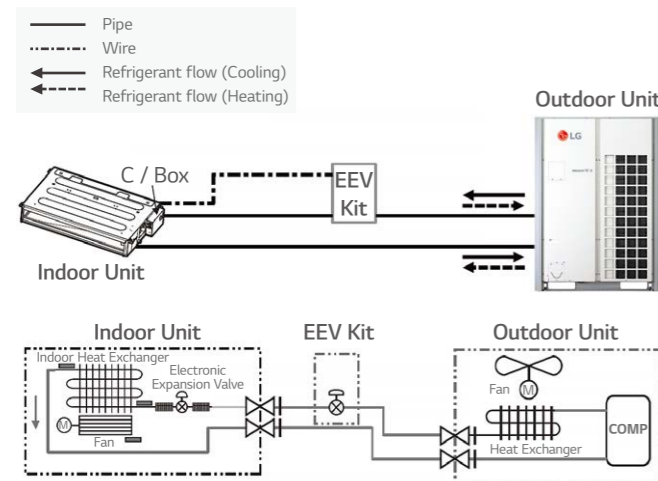

EEV Kit can be applied for the space which requires quiet and noise-sensitive.



Note : If you don't use EEV of same specification, Cooling (Heating) capacity could be decreased.

How to Install

- Open Indoor unit's control box cover.
- Open fully indoor unit's EEV through vacuum mode of ODU setting.
- Detach the Indoor unit's EEV connector from PCB and then push the reset button of Outdoor unit's PCB.
- After connecting indoor unit's EEV CONNECTOR, repeat the process ① & ②. Then, connect the EEV CONNECTOR of EEV KIT in PCB of indoor unit.
- Finally connect the lead wire of the EEV Kit to the indoor unit's PCB.
- Assemble the control box cover.

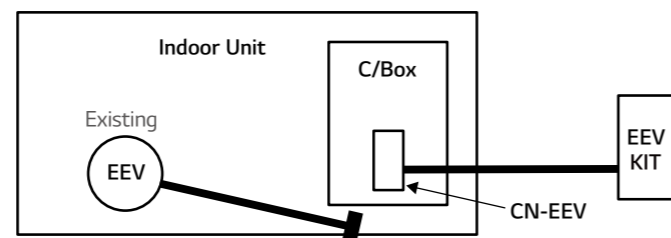

IR Receiver

Key Features

IR RECEIVER can be connected to ceiling concealed duct and floor standing unit which the customer wants to control by wireless remote controller.



- Designed for wireless control.
- Indication lamps (3 colors) and Self-diagnosis function.

Model Name

PWLRVN000

Applied Products

MULTI V Indoors (Ceiling Concealed Duct, Floor Standing Units)

Key Application

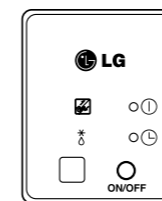
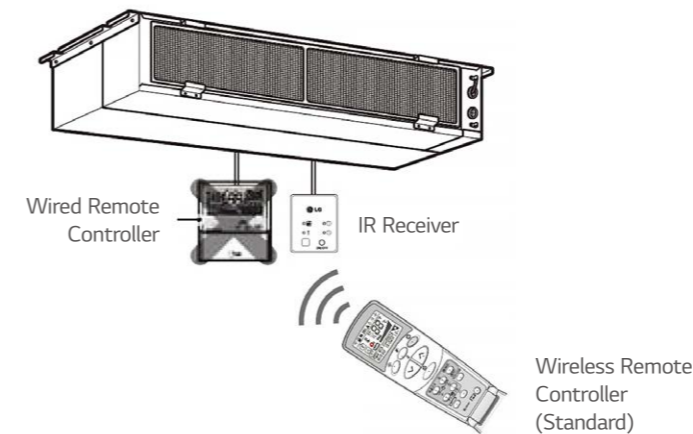

Operation of Indication Lamps

- Emergency Operation button :** Turns the indoor unit on or off when remote controller is not working.
- Signal Detector :** Receives the signal from remote controller.
- Timer lamp (Green) :** Lights up during the timer operation.
- Hotstart lamp (Orange) :** Lights up during the pre-heating operation, defrost operation as well as latent heat removal operation in heat mode. Available only for the heat pump models, not cooling only models.
- System On / Off lamp (Red) :** Lights up during system controller operation.
- Filter Sign lamp (Green) :** Lights up after 2,400 hours from the time of first power on operation.

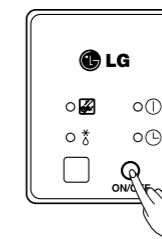
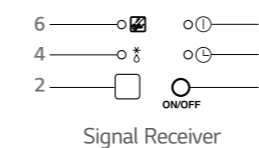

Test Run Mode

After installing the product, you must run a test run mode. Press the emergency operation button for 5 seconds, until the LED flickers. Then the indoor unit, duct runs cooling mode for 18 minutes, where the setting temperature is 18°C and the fan speed is high.

Note : Do not install both the IR Receiver and Wired Remote Controller. This may cause malfunctions.

MECHANICAL ACCESSORIES

Independent Power Module

Key Features

EEV fully close function in case of power cut.

Model Name

PRIPO

Applied Products

MULTI V Indoor Units



- Independent Power Module is specially designed to close the Indoor EEV when power cut-off.
- Supply Voltage : DC 12V ± 50%

Included Parts

Model	PRIPO		
Item	Independent Power Kit	Screw	Clamp (Tie Wrap)
Q'ty	1	2	4
Figure			

(Others)

- Harness 1 (1m)
- Harness 2 (1m)
- Harness 3 (1m)
- Installation Manual
- Insulation (PE)

Key Application

If the EEV is opened due to power cut off, liquid refrigerant flow into compressor which could damage the compressor in cooling mode. Also condensing might happened for unclosed EEV's Indoor unit due to flow of refrigerant.

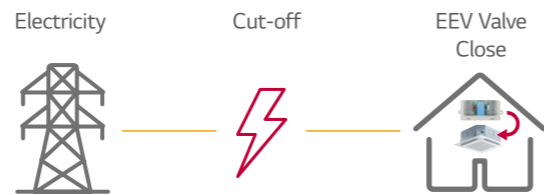

How to Install

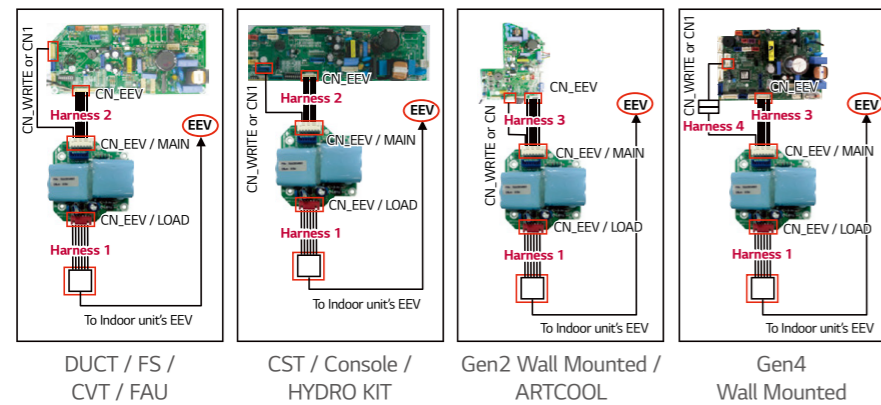

- ① Turn the power off using circuit breaker.
- ② Disconnect the EEV cable of the indoor unit's PCB (CN-EEV)
- ③ Connect the independent power module (CN-EEV/LOAD) to the indoor unit's EEV, using harness 1.
- ④ Connect the independent power module (CN-EEV / MAIN) to the indoor unit's PCB (CN-EEV / CN-WRITE), using harness 2 or 3.
- ⑤ Supply the power.

* FS : Floor Standing
 * CVT : Convertible
 * FAU : Fresh Air Intake Unit
 * CST : Cassette

Auxiliary Heater Relay Kit

Key Features

Providing an efficient way to add auxiliary heat.

Model Name

PRARS1

Applied Products

Wall Mounted, Art Cool Mirror, Art Cool Gallery

Model Name

PRARH1

Applied Products

1,2,4 Way Ceiling Cassette, High Static Ducted, Low Static Ducted, Ceiling Suspended



- Provides two stages of auxiliary heat for indoor unit.
- Provides ability to use the two stage auxiliary heater as the primary or secondary heating source.

Included Parts

Model	PRARH1			
Item	Auxiliary Heater Relay Kit	Screw	Insulation	Installation Manual
Q'ty	1	2	2	1
Figure				

Model	PRARS1			
Item	Auxiliary Heater Relay Kit	Screw	Insulation	Installation Manual
Q'ty	1	2	2	1
Figure				

Key Application

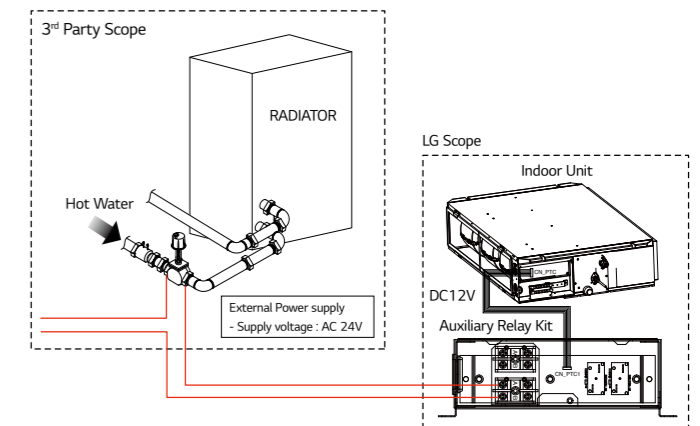

How to Install

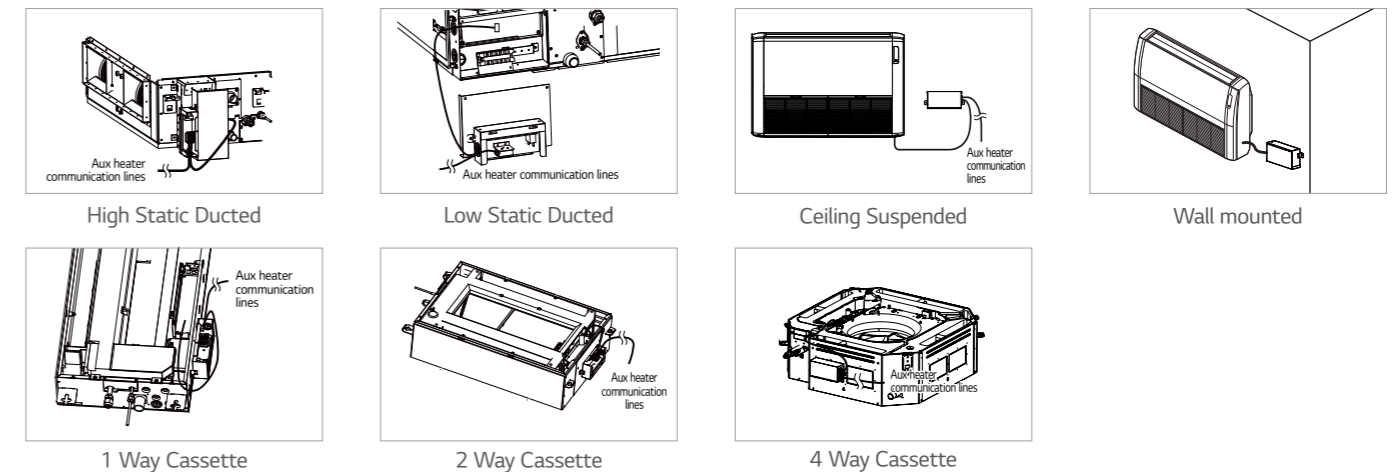

PIPING ACCESSORIES

Heat Recovery Unit

Key Features

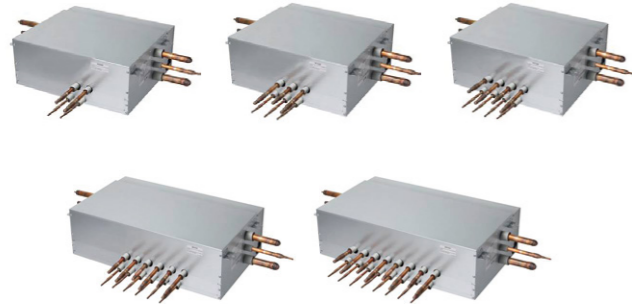

Model Name

- PRHR023 (2 Branch Unit)
- PRHR033 (3 Branch Unit)
- PRHR043 (4 Branch Unit)
- PRHR063 (6 Branch Unit)
- PRHR083 (8 Branch Unit)

Applied Products

- MULTI V 5
- MULTI V IV
- MULTI V Water IV

- Max. 64 indoor units can be connected. (Max. 8 indoor units per branch)
- It is easy to install due to the automatic search algorithm for piping detection.
- Subcooling cycle in HR unit makes the system efficiency maximum.

Connection Capacity

Maximum number of connectable indoor units :
64 IDUs / HR unit (in case of 8 ports model)

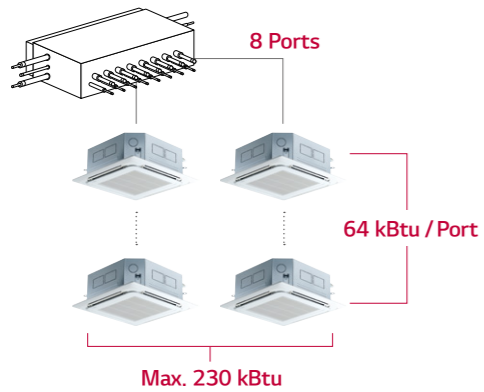

Flexible Connection

Series connection can be installed without pipes crossing.

New



Considering the direction for Indoor units and SVC port, connection for reverse direction makes much easier.

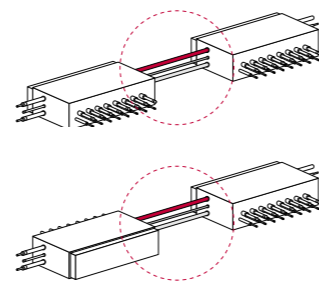

Reduce Noise

Heating → Cooling switching operation

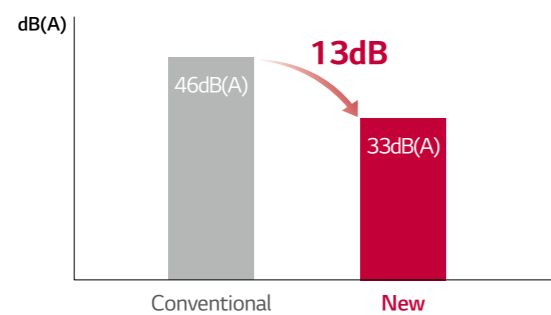

Test Condition (ISO Standard)

- Temp. : (Cooling) 27°C DB / 19°C WB, 35°C DB / 24°C WB
(Heating) 20°C DB / 15°C WB, 7°C DB / 6°C WB
- Operating : Cooling → Heating switching operation

Included Parts

- HR unit (1EA)
- Hanging bolts M10 or M8 (4EA)
- Nut M8 or M10 (8EA)
- Washers M10 (8EA)
- Reducers

Specification

Model		PRHR023	PRHR033	PRHR043	PRHR063	PRHR083		
Number of Branch	EA	2	3	4	6	8		
Maximum Connectable Capacity of Indoor Units (Per branch / unit)	kW	17.5/35	17.5/52.5	17.5/69.5	17.5/69.5	17.5/69.5		
Maximum Number of Connectable Indoor units per Branch	EA	8	8	8	8	8		
Nominal Input	Cooling	kW	0.040	0.040	0.040	0.076		
	Heating	kW	0.038	0.038	0.038	0.072		
Net. Weight	kg	18.5	20.3	22.0	28.3	31.8		
Dimensions (W x H x D)	mm	786 x 218 x 657	786 x 218 x 657	786 x 218 x 657	1,113 x 218 x 657	1,113 x 218 x 657		
Piping Connections	Indoor Unit	Liquid	mm (inch)	9.52 (3/8)	9.52 (3/8)	9.52 (3/8)	9.52 (3/8)	9.52 (3/8)
		Gas	mm (inch)	15.88 (5/8)	15.88 (5/8)	15.88 (5/8)	15.88 (5/8)	15.88 (5/8)
	Outdoor Unit	Liquid	mm (inch)	9.52 (3/8)	12.7 (1/2)	15.88 (5/8)	15.88 (5/8)	15.88 (5/8)
		Low Pressure	mm (inch)	22.2 (7/8)	28.58 (11/8)	28.58 (11/8)	28.58 (11/8)	28.58 (11/8)
	High Pressure	mm (inch)	19.05 (3/4)	22.2 (7/8)	22.2 (7/8)	22.2 (7/8)	22.2 (7/8)	
Power supply	∅, V, Hz	1, 220-240, 50 1, 220, 60	1, 220-240, 50 1, 220, 60	1, 220-240, 50 1, 220, 60	1, 220-240, 50 1, 220, 60	1, 220-240, 50 1, 220, 60		

Reducers for Indoor Unit and HR Unit

(Unit : mm)

Model	Liquid	High Pressure	Low Pressure
Indoor Unit Reducer			
PRHR023			
HR Unit Reducer			
PRHR033 PRHR043 PRHR063 PRHR083			

PIPING ACCESSORIES

Y Branch and Headerbranch

Key Features

For refrigerant distribution of indoor units



- Various Y Branch pipe of different capacities make MULTI V installation much easier.
- Y Branch and header branch for both gas and liquid are provided.
- Insulation material is also provided for covering the branches.

Model Name

Refer to specifications

Applied Products

- MULTI V 5
- MULTI V IV
- MULTI V III, MULTI V Plus II, MULTI V Plus
- MULTI V S
- MULTI V Water IV
- MULTI V Water II

Key Application

Heat Pump System

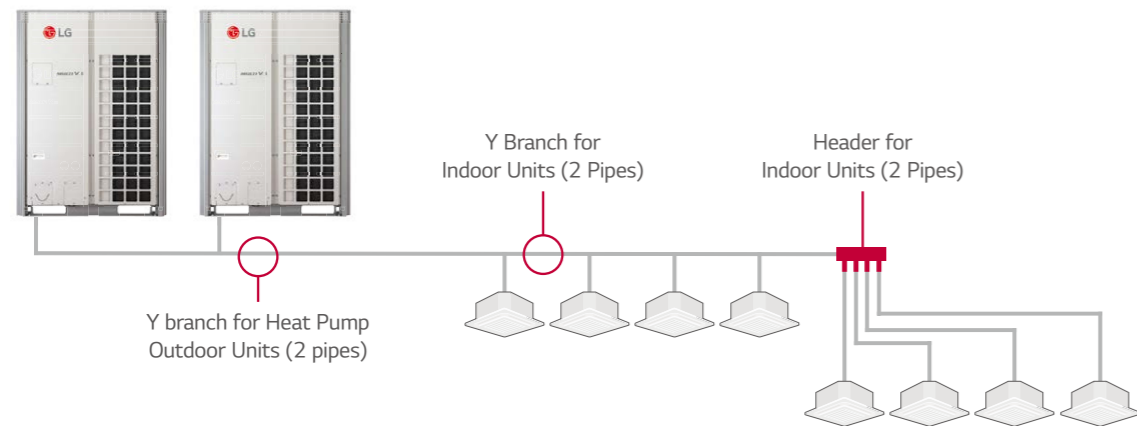

Heat Recovery System

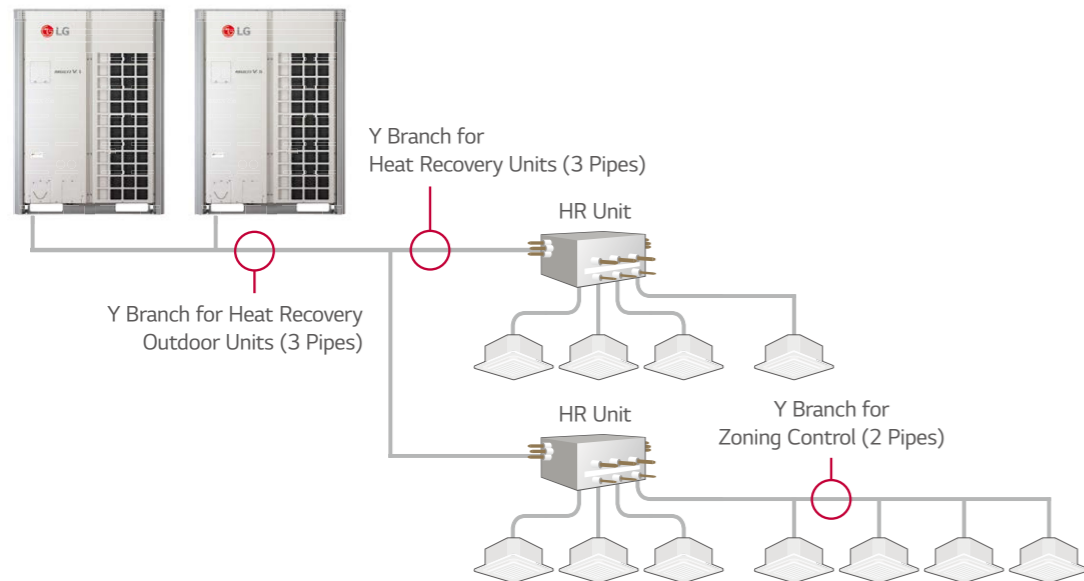

Specification

Header Branch

R410A

(Unit : mm)

Model	Gas Pipe	Liquid Pipe
ARBL054 (4 Branch)		
ARBL057 (7 Branch)		
ARBL104 (4 Branch)		
ARBL107 (7 Branch)		
ARBL1010 (10 Branch)		
ARBL2010 (10 Branch)		

PIPING ACCESSORIES

Y Branch and Header Branch

Specification

Heat Pump

R410A

MULTI V 5, MULTI V IV, MULTI V III, MULTI V WATER IV, MULTI V WATER II

(Unit : mm)

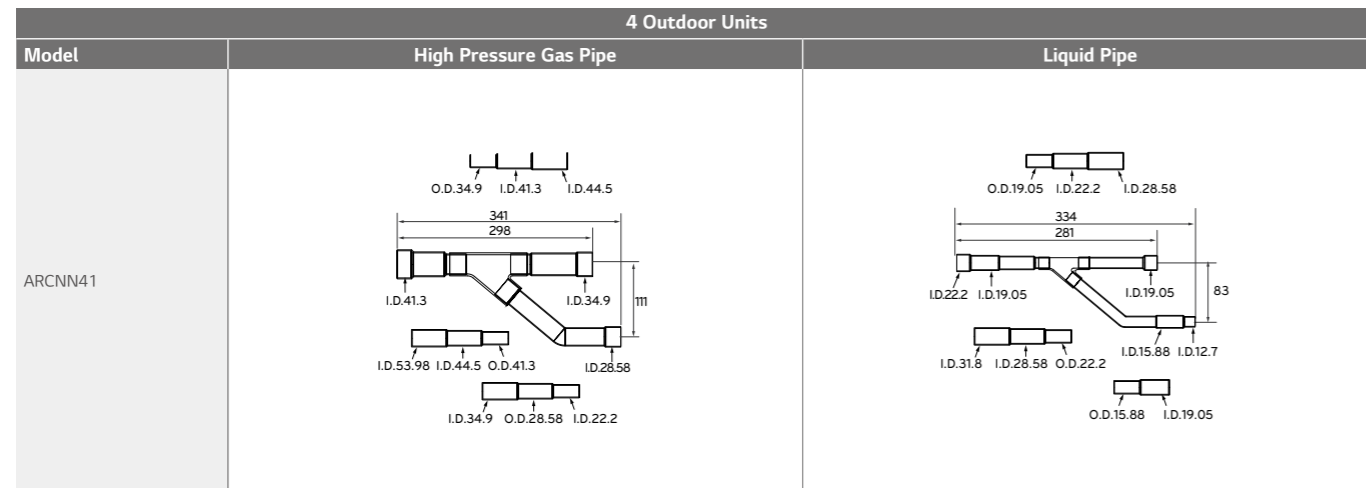
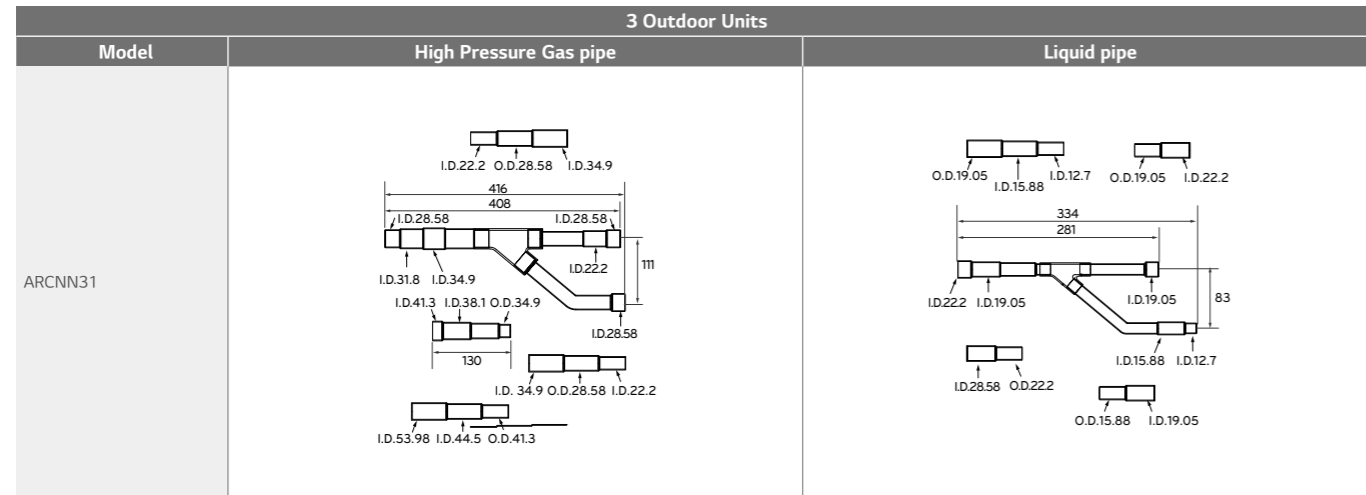
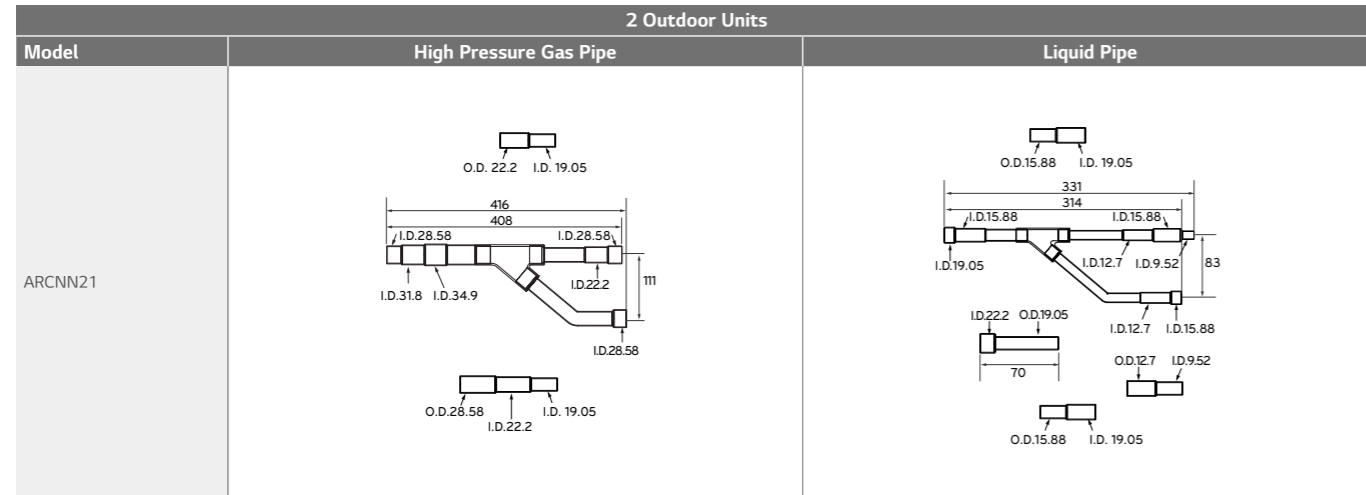

Specification

Heat Recovery

R410A

MULTI V 5, MULTI V IV HEAT RECOVERY, MULTI V III HEAT RECOVERY, MULTI V WATER IV HEAT RECOVERY, MULTI V WATER II HEAT RECOVERY

(Unit : mm)

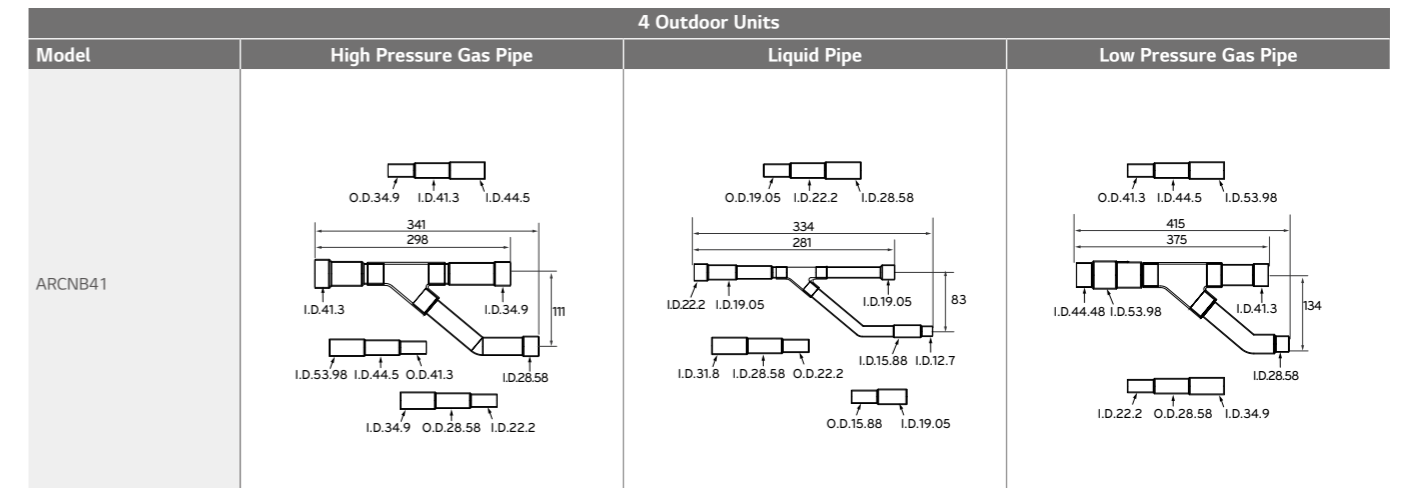
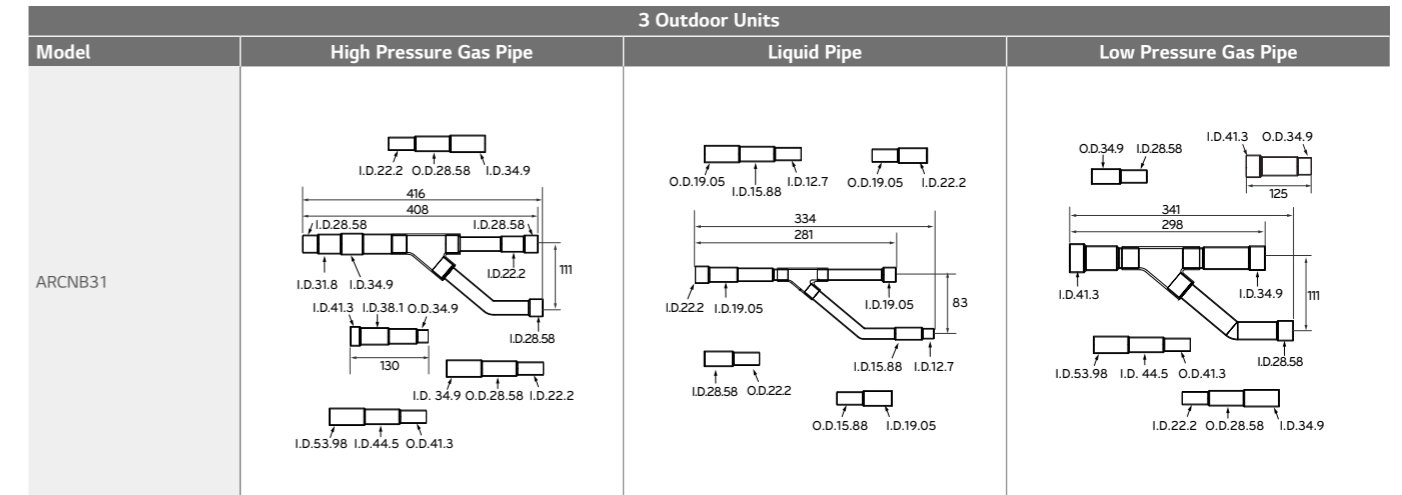
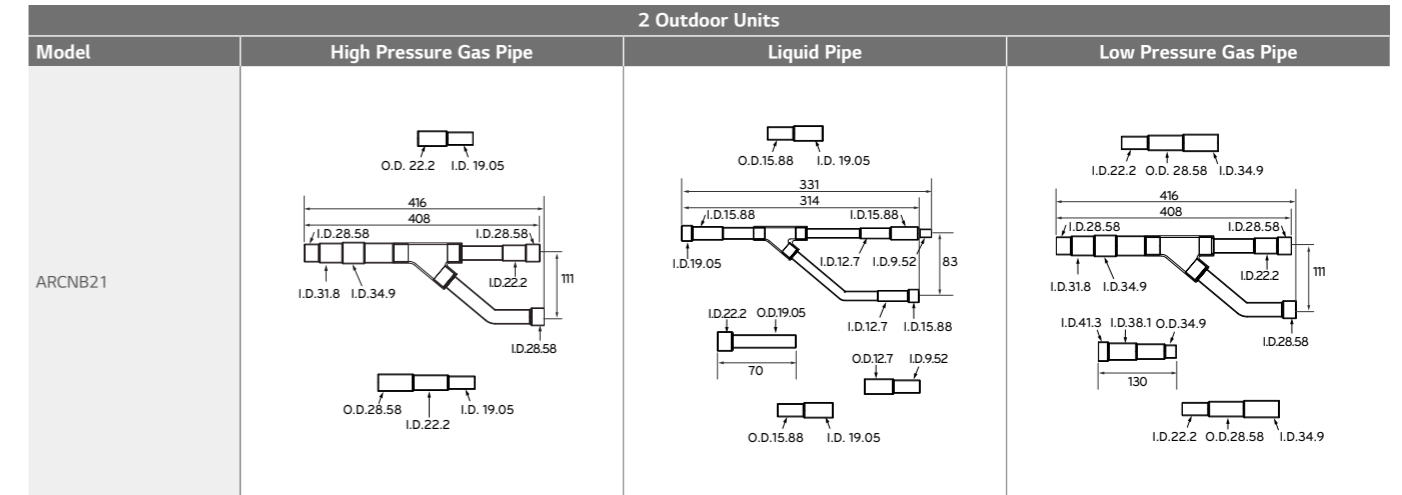

PIPING ACCESSORIES

Y Branch and Header Branch

Specification

Heat Pump, Heat Recovery Zone Control

R410A MULTI V 5, MULTI V IV, MULTI V III, MULTI V PLUS II, MULTI V PLUS, MULTI V S, MULTI V MINI, MULTI V SPACE II, MULTI V WATER IV, MULTI V WATER S, MULTI V WATER II

(Unit : mm)

Model	Gas Pipe	Liquid Pipe
ARBLN01621		
ARBLN03321		
ARBLN07121		
ARBLN14521		
ARBLN23220		

Specification

Heat Recovery

R410A MULTI V 5, MULTI V IV HEAT RECOVERY, MULTI V III HEAT RECOVERY, MULTI V WATER IV HEAT RECOVERY, MULTI V WATER II HEAT RECOVERY

(Unit : mm)

Model	High Pressure Gas Pipe	Liquid Pipe	Low Pressure Gas Pipe
ARBLB01621			
ARBLB03321			
ARBLB07121			
ARBLB14521			
ARBLB23220			

PIPING ACCESSORIES

Refrigerant Charging Kit

Key Features

Recharging refrigerant after a pump down or when refrigerant is either insufficient or excessive.

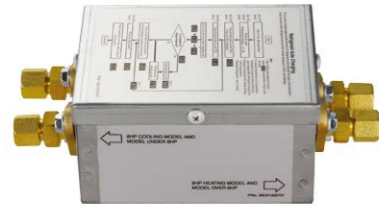

How to use

- Arrange manifold, capillary assembly, refrigerant vessel and scale.
- Connect manifold to the gas pipe service valve of outdoor unit as shown in the figure.
- Connect manifold and capillary tube. Use designated capillary assembly only. If designated capillary assembly isn't used, the system may get damaged.
- Connect capillary and refrigerant vessel.
- Purge hose and manifold.
- After "568" is displayed, open the valve and charge the refrigerant.

Model Name

PRAC1

Applied Products

- MULTI V 5
- MULTI V IV Heat Pump
- MULTI V IV Heat Recovery
- MULTI V III Heat Pump
- MULTI V III Heat Recovery
- MULTI V Plus II
- MULTI V Sync II

Key Application

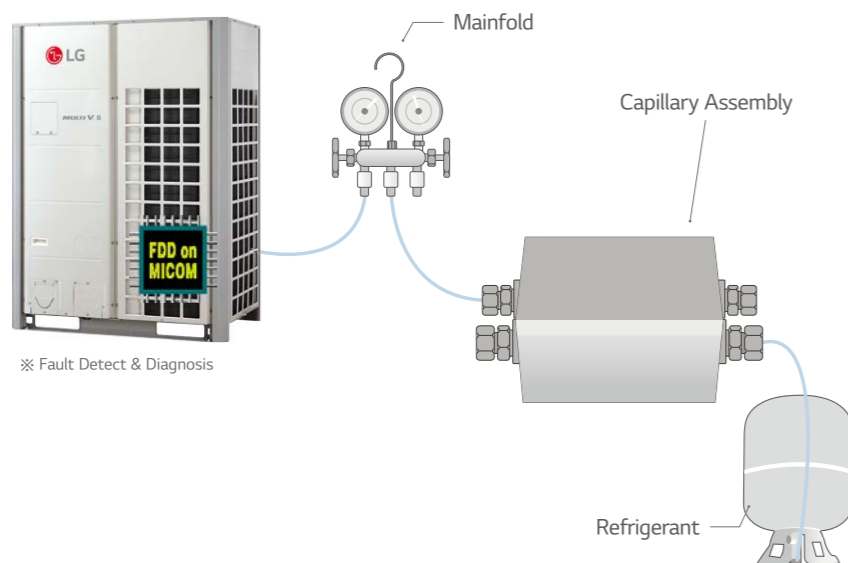

Drain Hose

Key Features

Easy drain installation.



Key Features

- It reduces the installation time by over 40% with elbow-less drain hose.
- Drain pump covers maximum 700mm high, featuring easy piping installation.

Model Name

- PHDHA05T
- PHDHA07T
- PHDHA05B
- PHDHA07B

Applied Products

MULTI V Indoor units

Key Application

- Ceiling Mounted Cassette and Ceiling Concealed Duct (refer to PDB for applicable model)

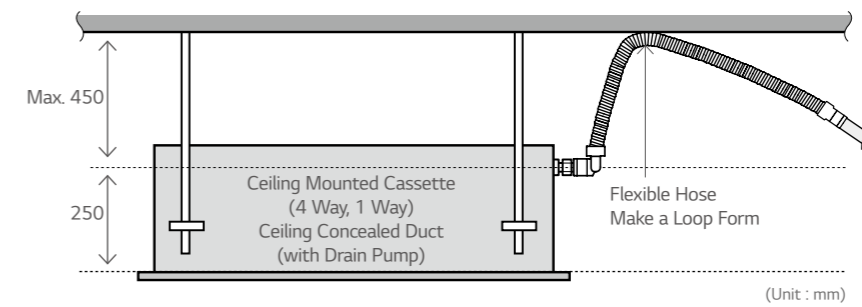

Specification

Model	Length	Quantity
PHDHA05T	500mm	30EA
PHDHA07T	700mm	30EA
PHDHA05B	500mm	5EA
PHDHA07B	700mm	5EA

PIPING ACCESSORIES

Stopper Valves

Key Features



- This unit can be applied for the additional indoor unit's installation.
- This unit can be applied for each indoor unit's service.

Model Name

- PRVT120 (Under 12.7mm)
- PMVT780 (Under 22.2mm)
- PMVT980 (Under 28.58mm)

Specification

Model	Specification
PRVT120	
PRVT780	
PRVT980	

How to Install

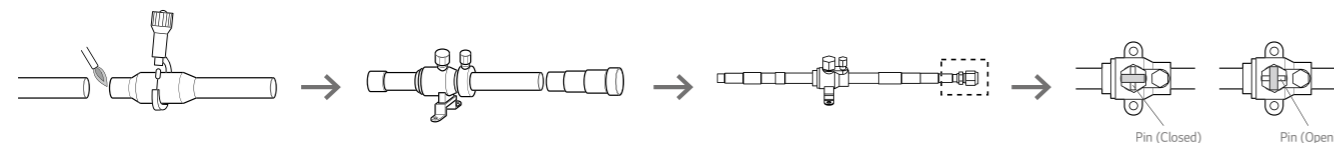

1. Cut the inlet side of the connector, and weld the pipe.
2. If installing additional indoor units, the outlet side connector should be cut according to installation pipe.
3. When installing a stopper valve, the flare part should be facing towards additional indoor unit.
4. When installing an additional indoor unit, the SVC valve should be in closed state.

※ When welding, service valve should be wrapped by wet cloth.

Application

(Room 3 & 4 : in use / Room 1 & 2 : need to install indoor units)

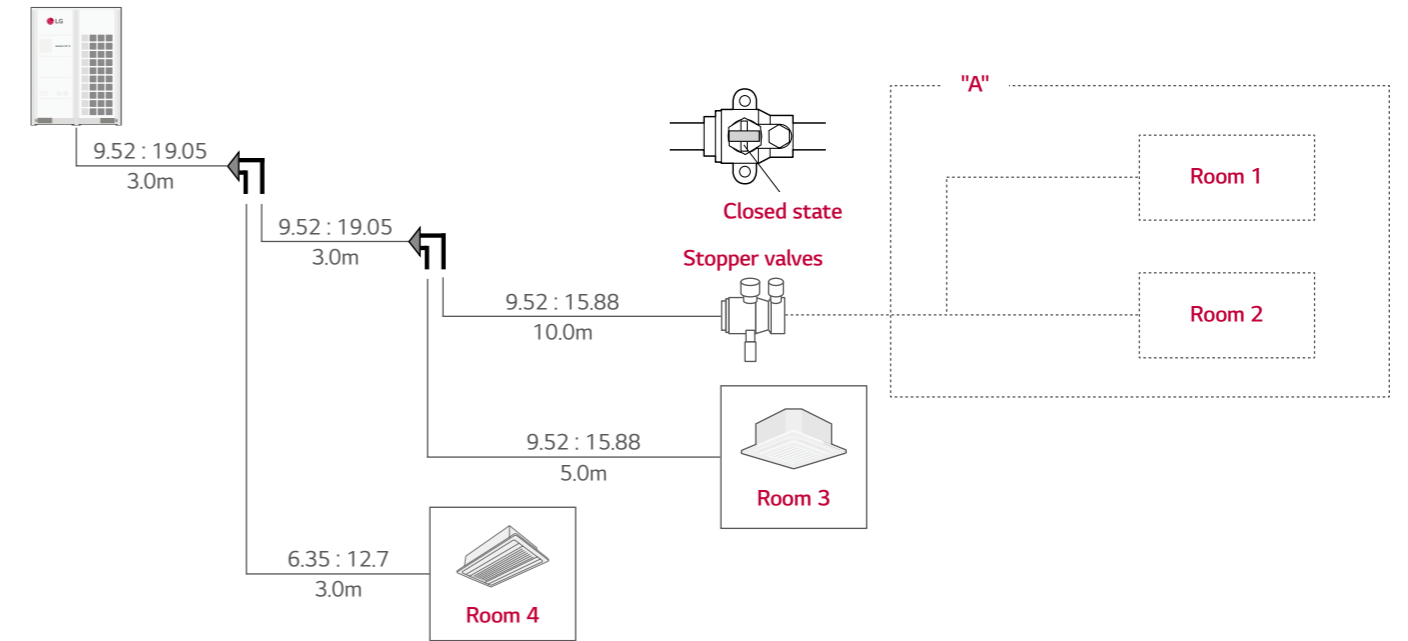

- In case of installation of additional indoor unit, refrigerant of used indoor unit must be discharged. (Room 3 & Room 4)
- If stopper valve is already installed, you can install additional indoor unit without refrigerant loss from the entire system.
- After installation of additional indoor unit, you just need refrigerant charging for "A" section.
- Then, open the stopper valve.

